



AGENDA

RĀRANGI TAKE

NOTICE OF AN ORDINARY MEETING OF

COUNCIL

to be held on **Thursday 26 May 2022** commencing at **1:00pm** in the Council Chambers,
36 Weld Street, Hokitika and via Zoom

Chairperson: Cr Carruthers (Deputy)
Members: His Worship the Mayor
Cr Hart
Cr Keogan
Cr Neale
Kw Madgwick

Cr Davidson
Cr Hartshorne
Cr Martin
Kw Tumahai



In accordance with clause 25B of Schedule 7 of the Local Government Act 2002, members may attend the meeting by audio or audio-visual link.

Council Vision:

We work with the people of Westland to grow and protect our communities, our economy, and our unique natural environment.

Purpose:

The Council is required to give effect to the purpose of local government as prescribed by section 10 of the Local Government Act 2002. That purpose is:

- (a) To enable democratic local decision-making and action by, and on behalf of, communities; and
- (b) To promote the social, economic, environmental, and cultural well-being of communities in the present and for the future.

1. KARAKIA TĪMATANGA OPENING KARAKIA

2. NGĀ WHAKAPAAHA APOLOGIES

3. WHAKAPUAKITANGA WHAIPĀNGA DECLARATIONS OF INTEREST

Members need to stand aside from decision-making when a conflict arises between their role as a Member of the Council and any private or other external interest they might have. This note is provided as a reminder to Members to review the matters on the agenda and assess and identify where they may have a pecuniary or other conflict of interest, or where there may be a perception of a conflict of interest.

If a member feels they do have a conflict of interest, they should publicly declare that at the start of the meeting or of the relevant item of business and refrain from participating in the discussion or voting on that item. If a member thinks they may have a conflict of interest, they can seek advice from the Chief Executive or the Group Manager: Corporate Services (preferably before the meeting). It is noted that while members can seek advice the final decision as to whether a conflict exists rests with the member.

4. NGĀ TAKE WHAWHATI TATA KĀORE I TE RĀRANGI TAKE URGENT ITEMS NOT ON THE AGENDA

Section 46A of the Local Government Official Information and Meetings Act 1987 states:

- (7) An item that is not on the agenda for a meeting may be dealt with at the meeting if –
 - (a) the local authority by resolution so decides, and
 - (b) the presiding member explains at the meeting at a time when it is open to the public, -
 - (i) the reason why the item is not on the agenda; and
 - (ii) the reason why the discussion of the item cannot be delayed until a subsequent meeting.
- (7A) Where an item is not on the agenda for a meeting, -
 - (a) that item may be discussed at the meeting if –
 - (i) that item is a minor matter relating to the general business of the local authority; and
 - (ii) the presiding member explains at the beginning of the meeting, at a time when it is open to the

public, that the item will be discussed at the meeting; but

(b) No resolution, decision, or recommendation may be made in respect of that item except to refer that item to a subsequent meeting of the local authority for further discussion.

5. NGĀ MENETI O TE HUI KAUNIHERA MINUTES OF MEETINGS

Minutes circulated separately via Microsoft Teams.

- **Ordinary Council Meeting Minutes – 28 April 2022**
- **Extraordinary Council Meeting Minutes – 5 May 2022**
- **Extraordinary Council Meeting Minutes – 11 May 2022**

Meeting Minutes to be received:

- **Planning Committee Meeting Minutes – 3 June 2021**
- **Community Development Meeting Minutes – 14 June 2021**
- **Capital Projects and Tenders Committee Meeting Minutes - 3 August 2021**
- **Planning Committee Meeting Minutes – 9 September 2021**
- **Community Development Committee Meeting Minutes – 20 October 2021**
- **CE’s Review Committee Meeting Minutes – 27 October 2021**
- **Audit & Risk Committee Meeting Minutes – 9 November 2021**
- **Capital Projects and Tenders Committee Meeting Minutes – 9 February 2022**
- **Audit & Risk Committee Meeting Minutes – 17 February 2022**

6. ACTION LIST

(Pages 6-9)

Chief Executive, Simon Bastion

7. NGĀ TĀPAETANGA PRESENTATIONS

- **WAKA KOTAHI NZ TRANSPORT AGENCY** (1:30-2:00pm)
Director Regional Relationships: James Caygill from Waka Kotahi NZ Transport Agency
- **CONSERVATION BOARD UPDATE** (*Verbal Presentation*) (2:00-2:30pm)
Chair of the West Coast Tai Poutini Conservation Board: Dr Mike Legge and Director of Operations Mark Davies: Department of Conservation.
- **COMMUNITY SERVICE AWARD** (3:15pm)
Deputy Mayor Carruthers to present to Howard Hughes

8. PŪRONGO KAIMAHI STAFF REPORTS

- **Financial Report to April 2022** (Pages 10-25)
Finance Manager: Lynley Truman
- **2022 Resident Satisfaction Survey – Results** (Pages 26-251)
Strategy & Communication Advisor, Emma Rae
- **Cook Flat and Lake Matheson Road Footpath/Cycleway as a new Council Asset** (Pages 252-264)
Transportation Manager: District Assets – Karl Jackson
- **Hokitika Museum Trust Board** Pages (265-267)
Group Manager: Regulatory and Community Services – Te Aroha Cook

9. ADMINISTRATIVE RESOLUTION:

Council is required to confirm its Seal being affixed to the following document:

- Consent pursuant to Part VIII Public Works Act 1981 for Grant Gibb’s Road Legalisation.

10. KA MATATAPU TE WHAKATAUNGA I TE TŪMATANUI RESOLUTION TO GO INTO PUBLIC EXCLUDED

(to consider and adopt confidential items)

Resolutions to exclude the public: Section 48, Local Government Official Information and Meetings Act 1987.

The general subject of the matters to be considered while the public are excluded, the reason for passing this resolution in relation to each matter and the specific grounds under Section 48(1) of the Local Government Official Information and Meetings Act 1987 for the passing of the resolution are as follows:

Item No.	General subject of each matter to be considered	Reason for passing this resolution in relation to each matter	Ground(s) under Section 48(1) for the passing of this resolution
1.	Confidential Minutes – 28 April 2022	Good reason to withhold exist under Section 7	That the public conduct of the relevant part of the proceedings of the meeting would be likely to result in the disclosure of information for which good reason for withholding exists. Section 48(1)(a)
2.	Pakiwaitara Building	Good reason to withhold exist under Section 7	That the public conduct of the relevant part of the proceedings of the meeting would be likely to result in the disclosure of information for which good reason for withholding exists.



Section 48(1)(a)			
3.	Heaney & Partners	Good reason to withhold exist under Section 7	That the public conduct of the relevant part of the proceedings of the meeting would be likely to result in the disclosure of information for which good reason or withholding exists.
Section 48(1)(a)			



This resolution is made in reliance on sections 48(1)(a) and (d) of the Local Government Official Information and Meetings Act 1987 and the particular interests or interests protected by section 7 of that Act, which would be prejudiced by the holding of the relevant part of the proceedings of the meeting in public are as follows:



Item No.	Interest
1	Protect the privacy of natural persons, including that of deceased natural persons ()
1	Protect information where the making available of the information: <ul style="list-style-type: none"> (i) would disclose a trade secret; and (ii) would be likely unreasonably to prejudice the commercial position of the person who supplied or who is the subject of the information (Schedule 7(2)(b)).
1, 2	Enable any local authority holding the information to carry on, without prejudice or disadvantage, negotiations (including commercial and industrial negotiations) (Schedule 7(2)(i))
3	Maintain Legal professional privilege Section 7(2)(g)
2	Protect information where the making available of information would be likely unreasonably to prejudice the commercial position of the person who supplied or who is the subject of the information. (Schedule 7(2)(ii))

**DATE OF NEXT ORDINARY COUNCIL MEETING – THURSDAY 23 JUNE 2022 (TBC)
COUNCIL CHAMBERS, 36 WELD STREET, HOKITIKA AND VIA ZOOM**

26.05.22 - Council Meeting - Action List

Item No.	Date of Meeting	COMPLETED IN PROGRESS OVERDUE	Item	Action	Completion Date/Target Date	Officer	Status
1	28.06.18		Kaniere School Students – Cycle trail 1. Crossing Progress 2. Crossing Placement 3. Site Visit (3 Actions merged 26.11.20 and updated)	Council staff to get back to the Kaniere School Students regarding the proposal.	Completed	GMDA, Transportati on Manager & CE	The site for the crossing has been revised based on a site visit by Mayor, CE & GMDA. As part of the works planned at the crossing, additional footpaths are to be created and the road is to be realigned and changed to a T-intersection. Contractor started works in February for intersection and reserve parking areas. Westland District Council (WDC) to liaise with the school re an official opening in 2022. Completed. WDC to coordinate an opening with the school
2	10.12.20		Speed Limit Register Review – Stage 2	Review of the speed limits on the below roads/areas: <ul style="list-style-type: none"> • Kokatahi/Kowhitirangi Area • Old Christchurch Road • Kaniere Road • Lake Kaniere Road and surrounding areas (Hans Bay, Sunny Bight, Lake Kaniere) 	Sep 2022	GMDA, Transportati on Manager & CE	This item is on hold awaiting Waka Kotahi NZ Transport Agency speed limit review. A review was presented to Council on the 30/09/21. Stage 2 to be reviewed & presented to Council in Feb 22 to begin public consultation with the intended implementation scheduled for April/May. This is in line with Waka Kotahi’s review period. Waka Kotahi has advised okay to start having conversations and consulting with public in the lead-up to rule changes being finalized toward mid-2022. Changes should not be made until new rules set. Council resolved in Feb to request feedback on other roads within WDC that wish the speed limits reviewed.

Item No.	Date of Meeting	COMPLETED IN PROGRESS OVERDUE	Item	Action	Completion Date/Target Date	Officer	Status
							This process has been deferred to after Annual Plan consultation. In the meantime, CE is happy to take any requests directly (email) and can be part of the submissions gathered.
3	10.12.20		Ross Chinese Gardens – Flooding issues	Update to Council on progress	Feb 2021	CE	<p>Lake level management – a meeting has been held, an engineering design will be completed, and an application for a resource consent has been submitted to the WCRC.</p> <p>Lake Level Project – onsite meeting with DoC was held. The engineering design will be completed and application for resource consent will be submitted to the WCRC, with an endeavour to have this completed through the summer period.</p> <p>WDC resource consent application completed and approved. WDC staff working with the community group to complete the diversion.</p> <p>WDC to liaise with Ross Chinese Gardens Community Group to try put a program of works together and get a firm answer regarding timeline / ETA on completion.</p>
4	26.08.21		Investigate costs to bring the WDC HQ & Pakiwaitara buildings up to 100% National Building standards	CE to discuss with Group Manager: District Assets	In progress	CE & GMDA	<p>Following preliminary structural surveys conducted by Simco, Josephs and Associates have been commissioned to arrange for the production of outline architectural drawings which will lead to the development of accurate costings.</p> <p>Council has requested a review of the strategic direction for both Council HQ & Pakiwaitara buildings to ensure the best-case scenario if progressed. CE expectations is that the options review will be presented back to council in the future as an options report.</p>

Item No.	Date of Meeting	COMPLETED IN PROGRESS OVERDUE	Item	Action	Completion Date/Target Date	Officer	Status
							Concept plans shared and viewed at Council Workshop 29/3/22. Refer to report in May confidential meeting.
5	26.08.21		Pakiwaitara Building Business Case Timeline	Business case and scope of work to be brought to Council after the structural elements of the work have been identified, costed and timelines finalized.	May 22	CE	As above. Concept plans shared and viewed at Council Workshop 29/3/22.Refer to report in May confidential meeting.
6	30.09.21		Road Maintenance Action Updates:	<ol style="list-style-type: none"> 1. Write to Waka Kotahi requesting that the 50km speeds north and south be extended to the existing 80km sign north and the south side of the Hokitika Bridge. 2. Install visible signage at Kanieri-Kowhitirangi Corner indicating 50km speed area and 30km for Camp and St Albans Street. 3. Change Railway Terrace, Hokitika to a one-way entrance from Weld Street with angle parking on both sides. 4. Change Hamilton Street, Hokitika to angle parking on both sides. 5. Pave the footpath area around Mitre 10 Hokitika with the recently approved stamped concrete surface to test its suitability for other parts of the CBD. 	Complete	CE & Transportati on Manager	<p>A parking presentation was delivered to Council on the 25 November 21.</p> <p>A report regarding changing Railway Terrace was presented at the Council meeting in November and a resolution passed.</p> <p>We have tabled the speed limit review with Waka Kotahi previously and will continue to follow up current status.</p> <p>The footpath program of works and current status update was provided to the Capital Projects & Tenders Committee.</p> <p>Footpaths in Haast, Franz Josef and Whataroa have been patch repaired, Park Street completed, Hokitika with Mitre 10 footpath underway.</p>

Item No.	Date of Meeting	COMPLETED IN PROGRESS OVERDUE	Item	Action	Completion Date/Target Date	Officer	Status
7	24.03.22		Racecourse Development Submission Bid	Council to be made aware of the outcome of the bid by end of April 2022	April Meeting	Council CE	Confirmed WDC application to the Infrastructure Acceleration Fund (IAF) has been accepted conditional of negotiations. 11 June workshop with IAF to discuss negotiation points
8	24.03.22		Gambling Policy	Council staff undertake social impact assessment and bring a report back to Council.	May Meeting	Council GMRCS	New impact assessment to be commissioned. Have moved the report to June council meeting
9	28.04.22		Hokitika Beach sign	Investigate the Hokitika Beach sign as a permeant feature when installing the beach Access Ramps	Jul 2022	Scott	DA team to have discussions with key stakeholders
10	28.04.22		LGNZ Invitation	Letter and Invitation to Chief Executive and the Chair of LGNZ, to give them the opportunity to convince us that WDC should remain a member.	Jun 2022	CE	Chief Executive and the Chair of LGNZ meeting with Councillors on the 22 May. Awaiting instructions following the outcome of the meeting.

Report to Council



DATE: 26 May 2022
TO: Mayor and Councillors
FROM: Finance Manager

FINANCIAL PERFORMANCE: APRIL 2022

1. Summary

- 1.1. The purpose of this report is to provide an indication of Councils financial performance for ten months to 30 April 2022.
- 1.2. This issue arises from a requirement for sound financial governance and stewardship with regards to the financial performance and sustainability of a local authority.
- 1.3. Council seeks to meet its obligations under the Local Government Act 2002 and the achievement of the District Vision adopted by the Council in June 2021, which are set out in the Long-Term Plan 2021-31. Refer page 2 of the agenda.
- 1.4. This report concludes by recommending that Council receive the financial performance report to 30 April 2022.

2. Background

- 2.1. Council receives monthly financial reporting so that it has current knowledge of its financial performance and position against budgets. A more detailed performance report is presented to the Audit and Risk Committee on a quarterly basis which includes non-financial information against KPI's adopted through the Long-Term Plan.
- 2.2. The Audit and Risk Committee received a report to the end of December 2021 and expressed concern about the number Activities for which Statement of Service and Performance Reports were not provided.

3. Current Situation

- 3.1. The financial performance report has had some changes made to the format and the actual data presented.
- 3.2. The information in the report is now of a more summarised nature, with only permanent variances over \$25,000 having comments. Temporary differences which are mainly budget

phasing are not commented on as these will either approximate budget by the end of the financial year or become a permanent variance which will be noted.

3.3. With the inclusion of the sustainability report, it is not necessary to include such detail to Council in the financial report, as the key business indicators are included in the sustainability report. A number of these indicators make up part of the covenants required to be reported half-yearly to the Local Government Funding Agency.

3.4. The financial performance report to 30 April 2022 is attached as **Appendix 1** and contains the following elements;

- 3.4.1. Sustainability report
- 3.4.2. Statement of Comprehensive Revenue and Expense
- 3.4.3. Notes to the Statement of Comprehensive Revenue and Expense
- 3.4.4. Statement of Financial Position
- 3.4.5. Revenue and Expenditure Graphs
- 3.4.6. Debtors
- 3.4.7. Debt position
- 3.4.8. Capital Report

4. Options

4.1. Option 1: The Council receives the Financial Performance Report to 30 April 2022

4.2. Option 2: The Council does not receive the Financial Performance Report to 30 April 2022

5. Risk Analysis

5.1. Risk has been considered and no risks have been identified in receiving the report, however if Council did not receive the report, it could be perceived that there was a lack of financial stewardship leading to reputational risk and conduct risk.

6. Health and Safety

6.1. Health and Safety has been considered and no items have been identified.

7. Significance and Engagement

7.1. The level of significance has been assessed as being low as the report is for information purposes only.

7.2. No public consultation is considered necessary

8. Assessment of Options (including Financial Considerations)

8.1. Option 1: The Council receives the report. This report is to inform Council on the monthly financial position and to encourage financial stewardship.

8.2. There are no financial implications to this option.

8.3. Option 2: If the Council does not receive the report there will be no oversight of the financial position of Council or whether the costs of Council are being managed in line with budgets.

8.4. There are no financial implications to this option.

9. Preferred Option(s) and Reasons

9.1. The preferred option is Option 1

9.2. The reason that Option 1 has been identified as the preferred option is that the report is administrative in nature and to do nothing could create risks to council. Council would be carrying out its administrative stewardship in receiving the report.

10. Recommendation(s)

10.1 That the Financial Performance Report for 30 April 2022 be received.

Lynley Truman
Finance Manager

Appendix 1: Financial Performance to 30 April 2022

Appendix 1



Financial Performance

Year to 30 April 2022

Contents

Sustainability Report	3
Statement of Comprehensive Revenue and Expense	4
Notes to the Statement of Comprehensive Revenue and Expense	6
Statement of Financial Position	7
Revenue & Expenditure Graphs	9
Debtors as at 30 April 2022	10
Rates Debtors as at 30 April 2022.....	10
Debt Position	11
Capital Report	12

Sustainability Report

Total revenue	Total expenditure	Total surplus/(deficit)
\$33.18M	\$22.56M	\$10.62M
Is 26.09% more than the total budget of \$26.32M	Is 0.05% less than the total budget of \$22.58M	Against a budget of \$3.74M

SUSTAINABILITY

Rates to operating revenue **44.75%**

Rates Revenue	\$14.85M
Operating Revenue	\$33.18M

44.75% of operating revenue is derived from rates revenue. Rates revenue includes penalties, water supply by meter and is gross of remissions. Operating revenue excludes vested assets, and asset revaluation gains.

Balanced budget ratio **147.06%**

Operating revenue	\$33.18M
Operating expenditure	\$22.56M

Operating revenue should be equal or more than operating expenditure. Operating revenue excludes vested assets and asset revaluation gains. Operating expenditure includes depreciation and excludes landfill liability and loss on asset revaluations. Year to date revenue is 147.06% of operating expenditure.

Interest to rates revenue (LGFA Cov.) **2.93%**

Net interest and finance costs	\$0.44M
Rates Revenue	\$14.85M

2.93% of rates revenue is paid in interest. Our set limit is 25% of rates revenue. Net interest is interest paid less interest received. Rates revenue includes penalties, water supply by meter and gross of remissions.

Interest to operating revenue **1.31%**

Net Interest and finance costs	\$0.44M
Operating revenue	\$33.18M

1.31% of operating revenue is paid in interest. Our set limit is 10% of operating revenue. Net interest is interest paid less interest received.

Liquidity Risk (LGFA Cov.) **153%**

Gross debt	\$27.82M
Undrawn committed facilities	\$3.98M
Cash and cash equivalents	\$10.87M

The liquidity risk policy requires us to maintain a minimum ratio of 110% which is also an LGFA covenant. Council's current liquidity risk is 153%. Gross debt includes pre-funding of \$6m invested in term deposit. Pre-funding of \$3m is due for repayment in May 2022.

Essential services ratio **153.23%**

Capital expenditure	\$7.98M
Depreciation	\$5.21M

Capital expenditure should be equal or more than depreciation for essential services. Year to date capex is 153.23% of depreciation. Essential Services are Water Supply, Wastewater, Stormwater, and Roding.

Statement of Comprehensive Revenue and Expense

Statement of Comprehensive Revenue and Expense							
	Notes	Full Year Forecast (\$000)	Full Year Budget (\$000)	YTD Budget (\$000)	Actual YTD (\$000)	Variance YTD (\$000)	Var/Bud %
Revenue							
Rates	01	17,725	18,030	15,154	14,849	(305)	-2.01%
Grants and subsidies	02	15,771	10,750	8,969	13,990	5,021	55.99%
Interest Revenue	03	59	8	8	59	51	676.09%
Fees and Charges	04	2,075	1,801	1,519	1,793	274	18.01%
Other revenue	05	2,834	1,009	669	2,494	1,825	272.90%
Total operating revenue		38,464	31,598	26,318	33,184	6,866	26.09%
Expenditure							
Employee Benefit expenses	06	5,322	5,474	4,565	4,414	(151)	-3.32%
Finance Costs	07	995	904	403	494	91	22.58%
Depreciation	08	8,002	7,864	6,553	6,692	138	2.11%
Other expenses	09	12,683	12,811	11,055	10,965	(90)	-0.81%
Total operating expenditure		27,002	27,053	22,576	22,564	(12)	-0.05%
Operating Surplus/(Deficit)		11,462	4,545	3,742	10,620	6,878	183.82%

Notes to the Statement of Comprehensive Revenue and Expense

Comments are provided on permanent variances over \$25,000.

01 Rates

Rates income is lower than planned mainly due to lower metered water usage as a result of lower tourism.

02 Grants and subsidies

Mainly due to unbudgeted and/or timing of grants received: Butlers landfill \$1.1m, 3 Waters grant \$2.8m, Mayor's Taskforce for Jobs \$500k, and Carnegie Building, \$500k.

03 Interest Revenue

Unbudgeted interest received from term deposits, mainly from grant funding and prefunding.

04 Fees and charges

Income is higher than planned mainly due to increased refuse fees collected at Hokitika transfer station \$165k, part of which came from Buller District, \$27k. Resource consents, Resource management processing fees and Building processing fees are collectively higher than budget by \$245k due to increased interest in the property market. Franz Josef refuse is \$81k below budget due to reduced tourism. Trade waste fees are \$40 below budget, also due to reduced tourism.

05 Other Revenue

Actual income is higher than planned mainly due to an unbudgeted gain on swaps, \$1.27m and income gained from vested assets, \$562k: Lake Matheson walkway, a constructed asset at Heritage Industrial Park, and part of Franz Josef watermains.

06 Employee benefit expenses

Actual salary cost is lower than planned due to unfilled roles.

07 Finance Costs

The variance is due to higher than budgeted interest rates which are offset by a gain in swaps reflected in other revenue.

08 Depreciation

Mainly due to depreciation of capitalised projects: Hokitika wastewater reticulation \$26k, and Fox landfill armouring \$32k; and shorter expected life of Westland Sports Hub (unfunded) than budgeted (\$48k additional).

09 Other expenses

The variance is mainly due to the timing of maintenance works.

Statement of Financial Position

Statement of Financial Position			
	March YTD 2022 (\$000)	Annual Plan 2021/2022 (\$000)	Actual 2020/2021 (\$000)
Assets			
Current assets			
Cash & cash equivalents	10,853	13,253	11,411
Debtors & other receivables	6,142	2,514	4,361
Assets held for sale		-	
Other financial assets	48	-	48
Total Current Assets	17,042	15,767	15,820
Non-current assets			
Council Controlled Organisation	8,695	11,010	8,695
Intangible assets	51	37	65
Assets Under Construction	22,148	-	10,088
Other Financial Assets	1,416	418	527
Property, Plant and Equipment	404,464	447,288	409,369
Deferred Tax	37		
Total Non-current assets	436,812	458,753	428,742
Total Assets	453,854	474,520	444,562
Liabilities			
Current liabilities			
Creditors & other payables	866	2,930	4,082
Employee benefit liabilities	631	446	436
Tax payable	-	3	
Borrowings	3,000	-	3,000
Derivative financial instruments		-	94
Other	2,938	425	6,554
Total Current Liabilities	7,434	3,804	14,166
Non-current liabilities			
Borrowings	24,818	33,734	18,818
Employee benefit liabilities	37	47	41
Provisions	1,846	2,371	1,846
Derivative financial instruments		583	536
Other Non-current liabilities		32	
Total Non-Current Liabilities	26,701	36,767	21,241
Total Liabilities	34,135	40,571	35,406
Net Assets	419,719	433,948	409,156

	February YTD 2022 (\$000)	Annual Plan 2021/2022 (\$000)	Actual 2020/2021 (\$000)
Equity			
Retained earnings	169,364	166,323	158,744
Restricted Reserves	10,538	9,361	10,538
Revaluation reserves	239,731	258,201	239,788
Other comprehensive revenue and expense reserve	87	64	87
Equity	419,719	433,949	409,156

Note:

Cash & Cash equivalents	
Grants and other receivables	4,000
Prefunding LGFA Loan	6,000
Bank balance from operations	868
Total	10,868

Operating Revenue Actual Year to April

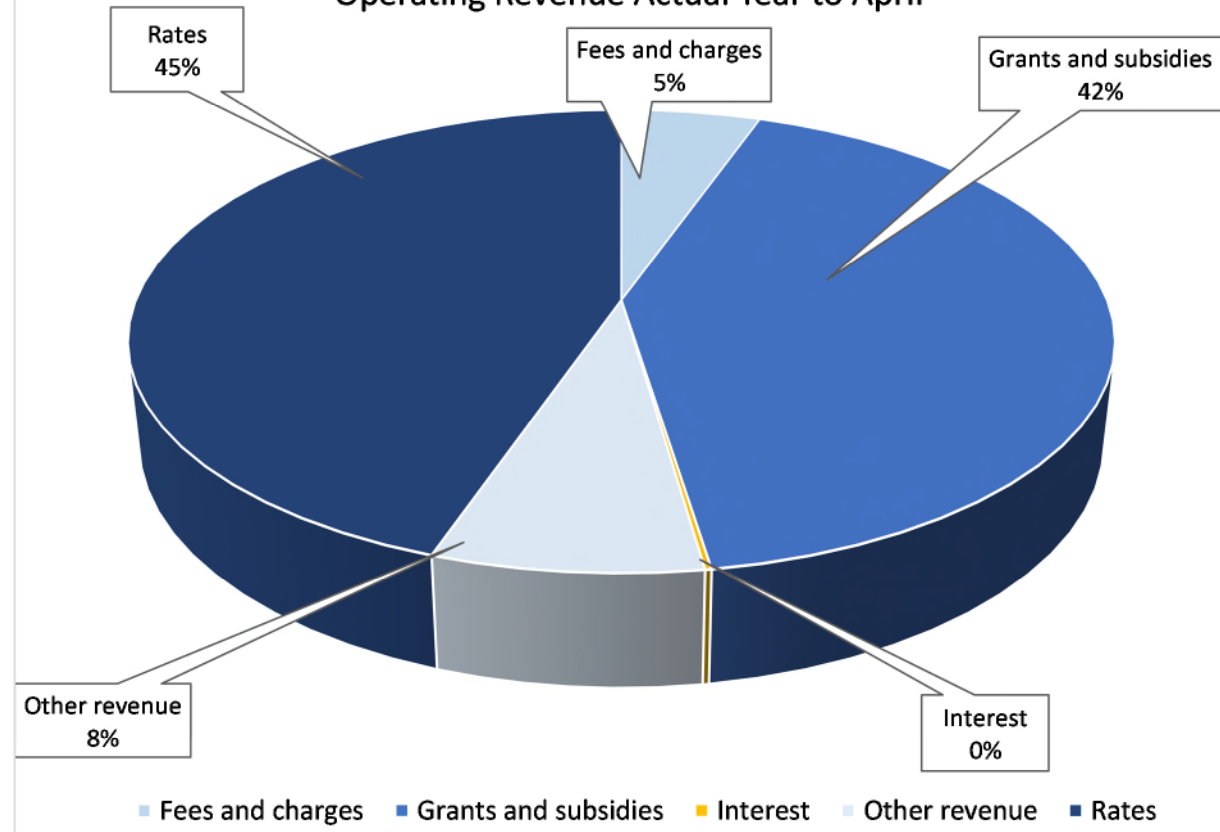

Operating Expenditure Actual Year to April

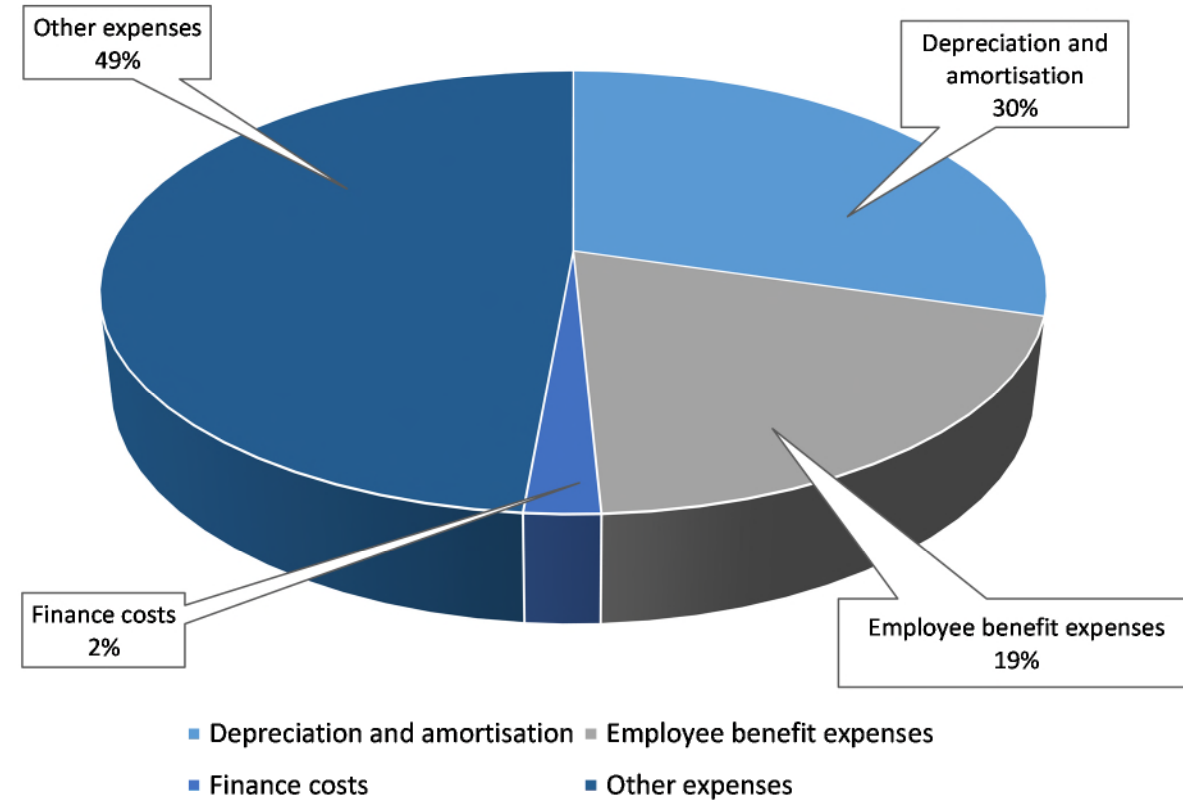

Operating revenue

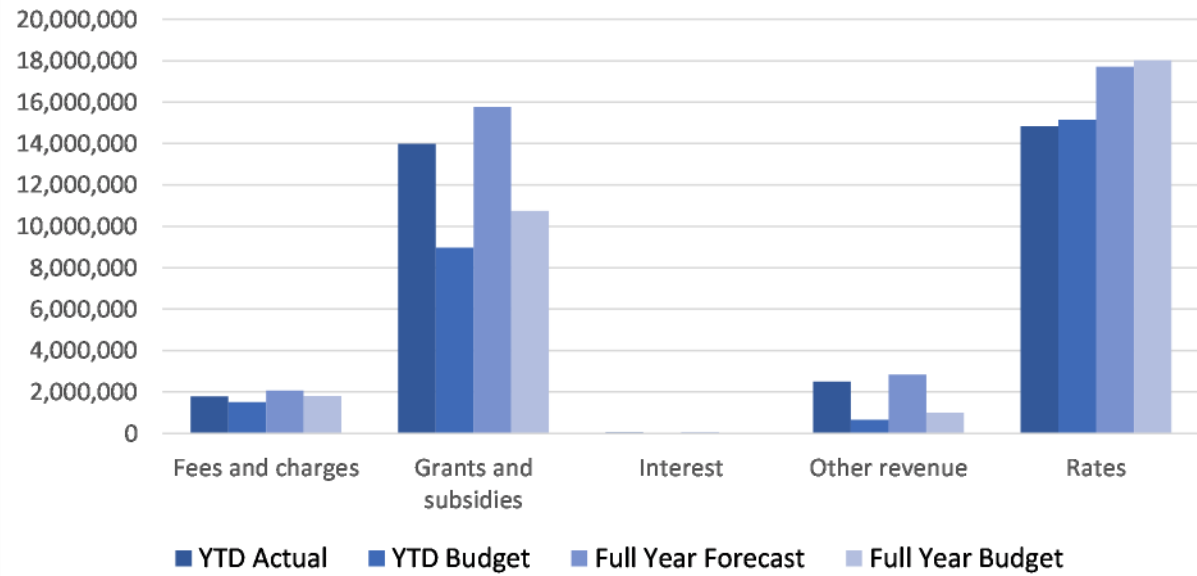

Operating expenditure

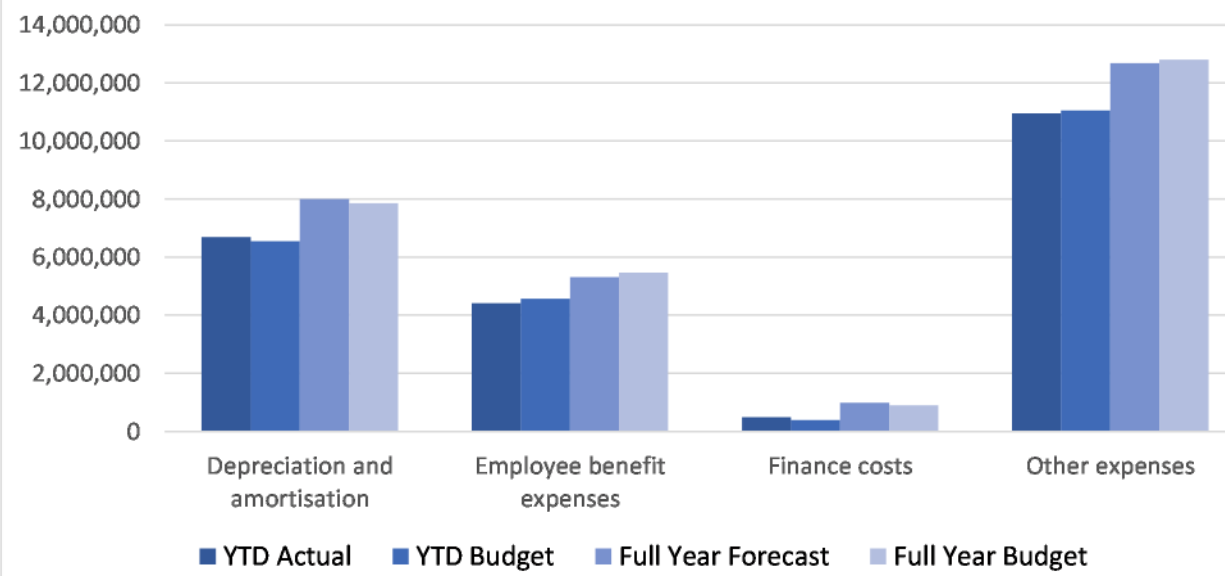

Debtors as at 30 April 2022

30/04/2022

Type	Over 90 Days	60-90 Days	30-60 Days	Current	Total (\$)
Building Consents	19,965	3,377	17,643	16,710	57,694
Building Warrants	556	-	-	(140)	416
Resource Consents	2,731	2,331	6,685	3,576	15,323
Sundry Debtors	86,742	418,727	27,604	662,565	1,195,638
Grand Total	109,994	424,436	51,931	682,711	1,269,071

30/04/2021

Type	Over 90 Days	60-90 Days	30-60 Days	Current	Total (\$)
Building Consents	28,910	2,274	1,689	22,871	55,745
Building Warrants	145	-	-	(290)	145
Resource Consents	-	186	26	(3,985)	3,773
Sundry Debtors	65,798	18,522	1,410,978	1,088,396	2,583,693
Grand Total	94,853	20,983	1,412,693	1,106,992	2,635,520

Rates Debtors as at 30 April 2022

Rates Debtors at 31 March 2022		625,146
Rates instalment	4,520,377	
Less payments received	-611,245	
Paid in advance change	-1,028,828	
Previous years write off's	-8,072	
Write off's	-3,687	
Penalties	-1,471	
Discounts	-97	
Court Cost	344	
		2,867,320
Total Rates Debtors at 30 April 2022		3,492,466
Arrears included above at 30 April 2022	3,492,466	
Arrears at 30 April 2021	3,087,687	
Increase/(decrease) in arrears		404,779

The increase in rates arrears is due to the increase in rates levied in 2022 compared to 2021. Also, in the current quarter a net additional \$47.3k was charged for wastewater as a result of the review of pan

Debt Position

Debt Position 2021/2022 (\$000)

	Jun-21	Jul-21	Aug-21	Sep-21	Oct-21	Nov-21	Dec-21	Jan-22	Feb-22	Mar-22	Apr-22	May-22	Jun-22
Actual Debt Position	21,818	21,818	21,818	24,818	24,818	24,818	24,818	24,818	24,818	24,818	27,818		
Budget	21,818	21,818	21,818	21,818	21,818	21,818	21,818	21,818	21,818	29,103	29,103	29,103	29,103
Forecast												27,818	29,103

Forecast Debt Position for 2021-2022 Financial Year

Forecast as at	Jun-22
Opening Balance	21,818
Loan funded capex forecast	8,235
Forecast repayments 2021-22	-950
Forecast balance June 2022	29,103

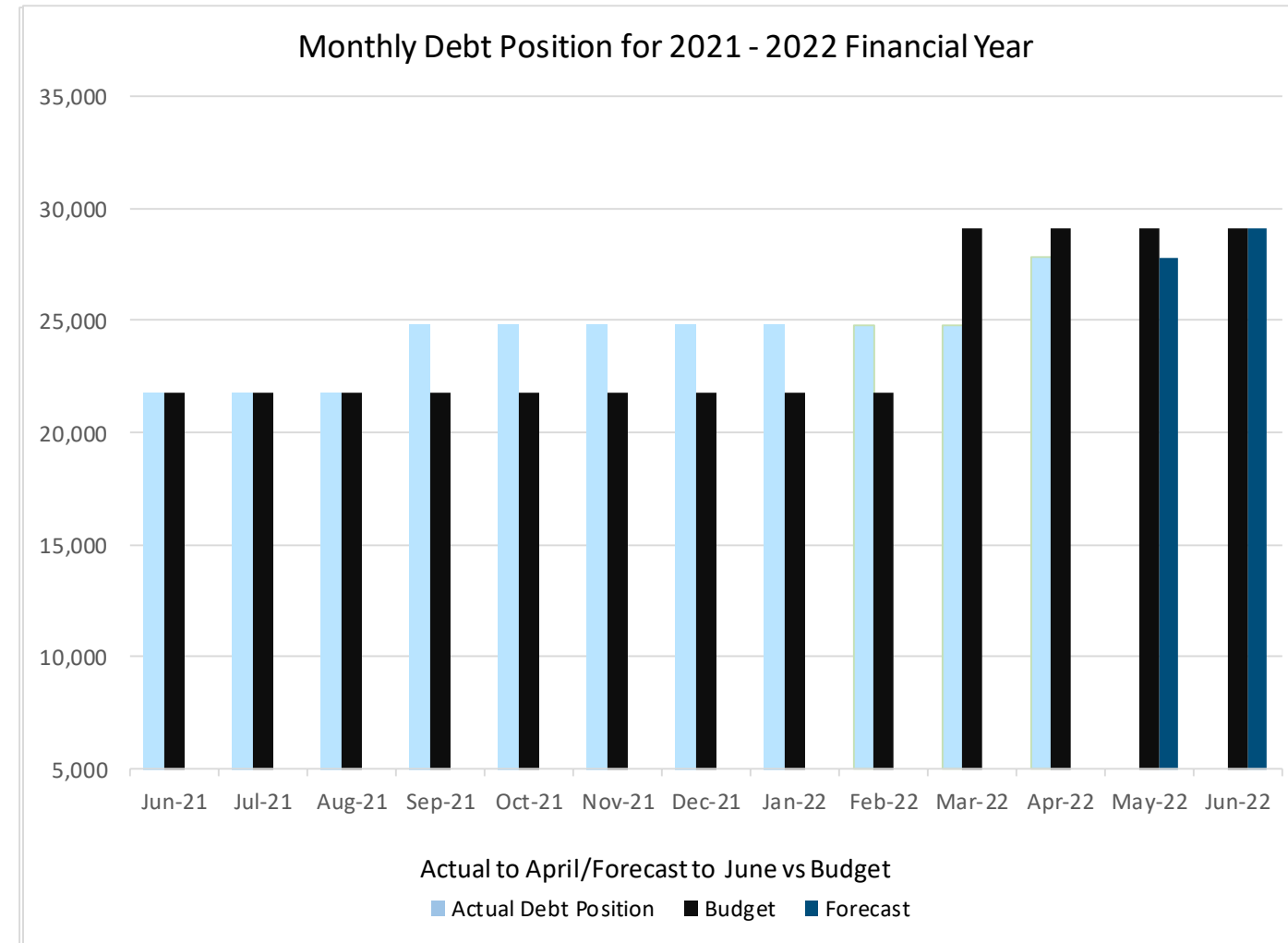

CAPITAL EXPENDITURE 2021-2022

	Budgets			Expenditure			Notes	Commitments / projected carry overs				
	2020-2021 Carried Forward Budget	Approved additional	Full Year Annual Plan	YTD Actual Expenditure	Budget Remaining	YTD Spent %		Open Purchase Orders	Commitment as a % of Original Budget Remaining	Proposed 2023/31 carry overs	Proposed carry overs notes	CY Budget Remaining after Commitments and proposed carry overs
Leadership	\$151,825		\$1,022,280	\$158,972	\$1,065,483	14%	Main projects included in this section are the Council's HQ earthquake strengthening (waiting on costings from Joseph & Associates); refurbishment of the visitor area projects; and IT Equipment renewals. The refurbishment of the visitor centre area project is on hold pending further discussions around the location of Council Chambers.	\$29,618	3%	\$780,920	HQ Earthquake strengthening	\$254,945
Planning & Regulatory Services	\$243,158		\$600,000	\$26,428	\$816,730	3%	These are all Civil Defence projects: Council is in consultation with other agencies to determine their involvement in the EOC.	\$11,641	1%	\$798,527	CD Emergency Operations Centre and Communications equipment	\$6,563
Facilities, and Leisure Services - Park & Reserves	\$836,501		\$1,819,500	\$204,327	\$2,453,720	8%	The main projects included in this section are Cass Square development projects (Toilet facilities, upgrade of playground equipment etc.); WCWT Trail projects; Waterfront Development (beach access, landscaping & structures, relocation of FENZ practice eqpmt). Other projects are the Whataroa, Haast and Kumara playground equipment upgrades. The Ross playground equipment upgrade is on hold following Community discussions. TIF funding of \$191.5k has now been approved for the new Cass Square toilets and the toilets have been ordered.	\$770,968	31%	\$1,029,710	Ross Playground Equipment and Hokitika Dog Park. Also, Mahinapua Viewing Platform (\$38k); and Wainihinhi wet weather route bridge (\$160k) which is now planned to be linked to a potential Arahura Cycleway enhancement. Cass Square playground, skatepark & rubber matting (\$721.5k)	\$653,041
Facilities, and Leisure Services - Other	\$1,072,161	\$250,000	\$4,754,000	\$2,119,295	\$4,686,077	35%	The major projects included in this section are the Carnegie building earthquake strengthening and fitout; Jacksons Bay Wharf; Hokitika and Franz Josef revitalization plan projects; lighting and flag trax system for Hokitika; and the Museum archives work. The flag trax system has been installed. Carnegie Building earthquake strengthening is nearing completion.	\$1,199,965	26%	\$2,969,153	Mainly Pakiwaitara projects (\$1.4m); Carnegie fitout and archives (\$1.4k); and b/fwd Hokitika pool works (\$68k) due to funded works.	\$516,959
Solid Waste	\$148,100		\$404,000	\$171,416	\$407,192	31%	The Butlers intermediate capping project continues to be carried over due to funding received to transfer the Fox Landfill waste to Butlers Landfill. Franz Josef landfill final capping; Haast capping and the transfer station; and Hari Hari landfill protection projects have also been extended into the current year with additional funding for the latter three. New projects this year which are underway include Refuse shed 1 door and iron replacement and equipment for Waste Minimisation.	\$3,103	1%	\$199,108	Haast capping (\$15k); development of Haast transfer station (\$100k); and Butlers intermediate capping.	\$204,982

Transportation	\$0		\$4,506,879	\$1,523,744	\$3,095,714	34%	Major projects included here are SPR Low Cost Low Risk resilience; Sealed Road resurfacing; Structures Component Replacement (incl. bridges); Sealed Road Resurfacing; Unsealed Road Metalling; Drainage Renewals; and Traffic Services Renewals.	\$15,900	1%	\$0	These projects are funded to either 62% or 100% by NZTA. The current funding period is 2022-2024 and there is flexibility to re-allocated between these years where the budget has been underspent or is required to be brought forward. A three-month program of work has been prepared for the remaining budget.	\$3,079,814
Stormwater	\$1,714,627		\$792,400	\$237,201	\$2,271,844	9%	The key project this year is the Livingstone St Pump upgrade which is underway. Other projects include mains replacement; Tancred and Sewell St pump upgrades; and the Jollie St extension and Beach St re-alignment. All projects are either underway or completed apart from Livingstone St pump upgrade which is at final design stage and Jollie St extension, for which tender documents are being reviewed; and Beach St re-alignment.	\$87,677	4%	\$300,000	Beach Street re-alignment - design being rescoped.	\$1,884,167
Wastewater	\$3,411,652		\$122,831	\$153,902	\$3,381,981	4%	The main projects relate to Hokitika waste water management, with a feasibility study underway for the Hokitika WW Treatment plant under the Reform Package projects. Other key projects are the Fox Glacier WWTP upgrades (completed); Hokitika Pump upgrade (Kaniere) which is due to commence in May and the Hokitika Z-line section replacement.	\$197,302	6%	\$3,112,872	Hokitika Outfall Structure, WWTP and Z-Line replacement	\$71,806
Water Supply	\$1,749,624	\$300,000	\$925,000	\$581,076	\$2,393,548	20%	The Fox Glacier Plant upgrade project has commenced. The Ross new intake project is scheduled to commence in January. Commissioning can begin on the Arahura water treatment plant once the power supply has been connected (subject to approval by Kiwirail). Closing date for pPrices for the Hokitika mains upgrade program is 9th March. The mains upgrade programme for Kumara is waiting on a start date from Westroads. The Hokitika seismic valve (main outlet) is on order but not due in until February.	\$1,279,376	53%	\$924,942	Fox Glacier Plant Upgrade \$750k and Hari Hari Mains upgrade programme	\$189,230
Unbudgeted Capital Expenditure	-	-	-	\$367,471	\$0		This relates to additional HQ refurbishment costs (\$18k); teleconferencing costs (\$5k); and new water (\$6k) and storm water connection (\$4k) requests from ratepayers; plus unforeseen stormwater assets required (\$4k); carbon credits (\$268k) which will be offset by disposals; and various projects for which funding has been received, such as the Paringa Conveniences.	\$434,247	-	-		N/A
Total Capital Expenditure	\$9,327,649	\$550,000	\$14,946,890	\$5,543,833	\$20,572,288	22%		\$4,029,797	20%	\$10,115,232		\$6,861,506
Externally funded Capital Expenditure	\$11,399,492	\$0	\$0	\$8,055,636	\$3,860,724	71%	The main projects included here are the PGF funded Cron St and footpath extensions (\$1.5m) and the sealing of Old Christchurch Road (\$3.2m); Hokitika Swimming Pool (\$2.6m funding contribution); Butlers new cell development project (\$3.3m) and the Stimulus Funded 3Waters Reform projects (\$6.9m). The 3 Water Reform funded projects have either been completed or are on track for completion by 30 June. The Hokitika swimming pool has re-opened after the completion of Stage 1.	\$1,059,144	27%	\$0		\$1,059,144
Total Capital Expenditure	\$20,727,140	\$550,000	\$14,946,890	\$13,599,469	\$24,433,013	38%		\$5,088,941	21%	\$10,115,232		\$7,920,651

Report to Council



DATE: 26 May 2022
TO: Mayor and Councillors
FROM: Strategy and Communications Advisor

2022 Resident Satisfaction Survey - results

1. Summary

- 1.1. The purpose of this report is to provide Council with an overview of the results of the 2022 Residents' Satisfaction Survey (the Survey) [Appendices 1 and 2].
- 1.2. This issue arises from the need to survey resident opinions about Council's services to report to various key performance measures adopted during the Long Term Plan process.
- 1.3. Council seeks to meet its obligations under the Local Government Act 2002 and the achievement of the District Vision adopted by the Council in June 2021, which are set out in the Long Term Plan 2021 - 31. Refer page 2 of the agenda.
- 1.4. This report concludes by recommending that Council receive this report and the Survey and instruct staff to make the Survey available to the public on the Council's website.

2. Background

- 2.1. The reason the report has come before the Council is to inform elected members of the biennial Residents' Satisfaction Survey results. The Survey questions are derived from customer satisfaction measures in the Long Term Plan performance measures for various activity groups across the Council.
- 2.2. Every two years the Council contracts an external market research company to conduct a residents' satisfaction survey on their behalf. The three previous surveys were done by National Research Bureau, however they ceased offering the service to Councils prior to contracting the 2022 survey.
- 2.3. For the 2022 survey staff contracted Key Research. Staff agreed to an amended scale of 1 – 10 for satisfaction to ensure that the results can be benchmarked against other Council surveys conducted by Key Research. A separate document with full benchmarked results will be supplied to Council later in the year when Key Research have completed surveys for other Councils.
- 2.4. The Survey was open from 11 February to 29 March 2022. The data collection methodology used by Key Research was a mixed method:
 - 2.4.1. Residents from within the Westland District aged 18 years or older were randomly selected from the Electoral Roll to partake in the survey. Postcard invitations that contain the online survey link as well as paper survey questionnaires were sent out.

2.4.2. Telephone interviewing was also conducted using a Computer-Aided Telephone Survey (CATI) platform. Landline and mobile contacts were used.

2.5. The survey generated a total sample of n=365 residents (123 residents via the postal to online method and 242 residents via telephone interviewing) across the Westland District.

3. Current Situation

3.1. Results of the Survey should be considered against the environmental background of the past two years and the impact of Covid-19, including the fact that the Survey was undertaken at the time Vaccine Passes were required at Council facilities. Public perception of Council is likely to be negatively influenced by this environment.



Report | April 2022



Summary of key performance indicators

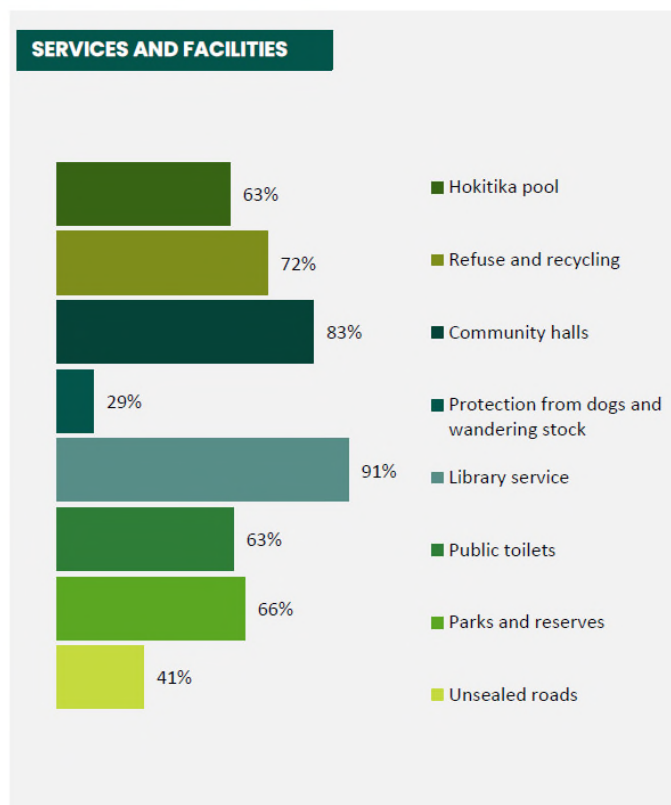
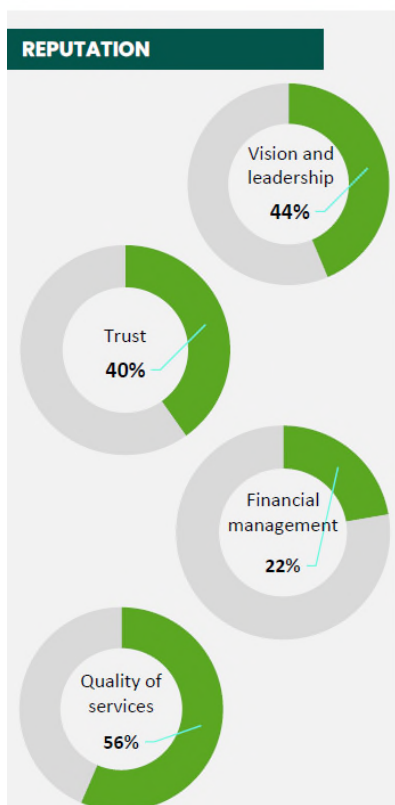
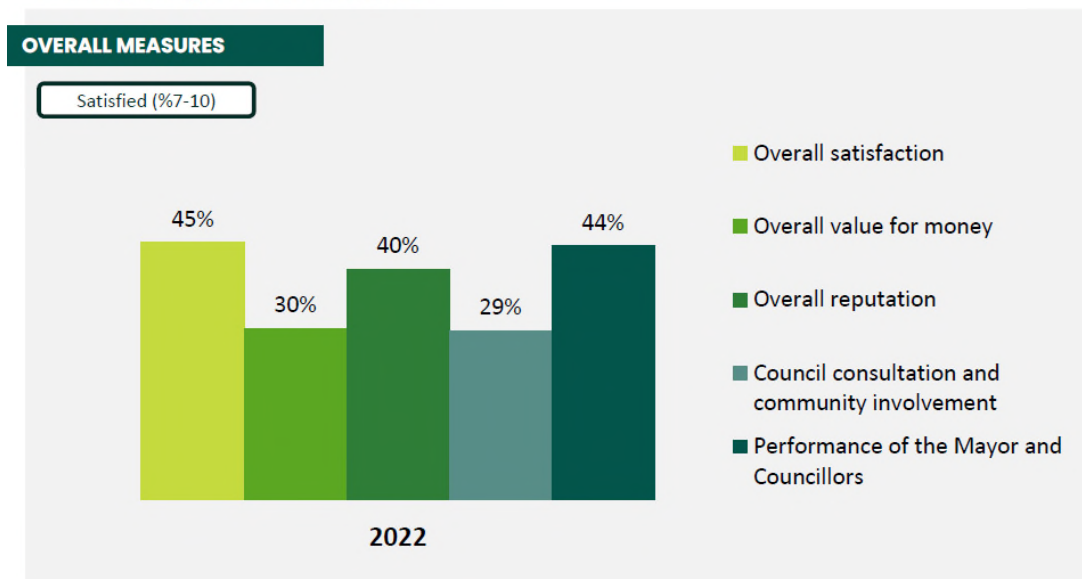

3.2. Research First Limited produces a Perceptions of Local Government update that provides some comparative data for the overall measures over each quarter. Residents overall satisfaction with Westland District Council is slightly higher than the overall satisfaction of residents in areas outside of Auckland (45% : 42%). Westland residents also believe they get better value for money from Council services (30% : 26%). However, Westland residents are less satisfied with Council consultation and community involvement (opportunities to have my say) (29% : 45%).

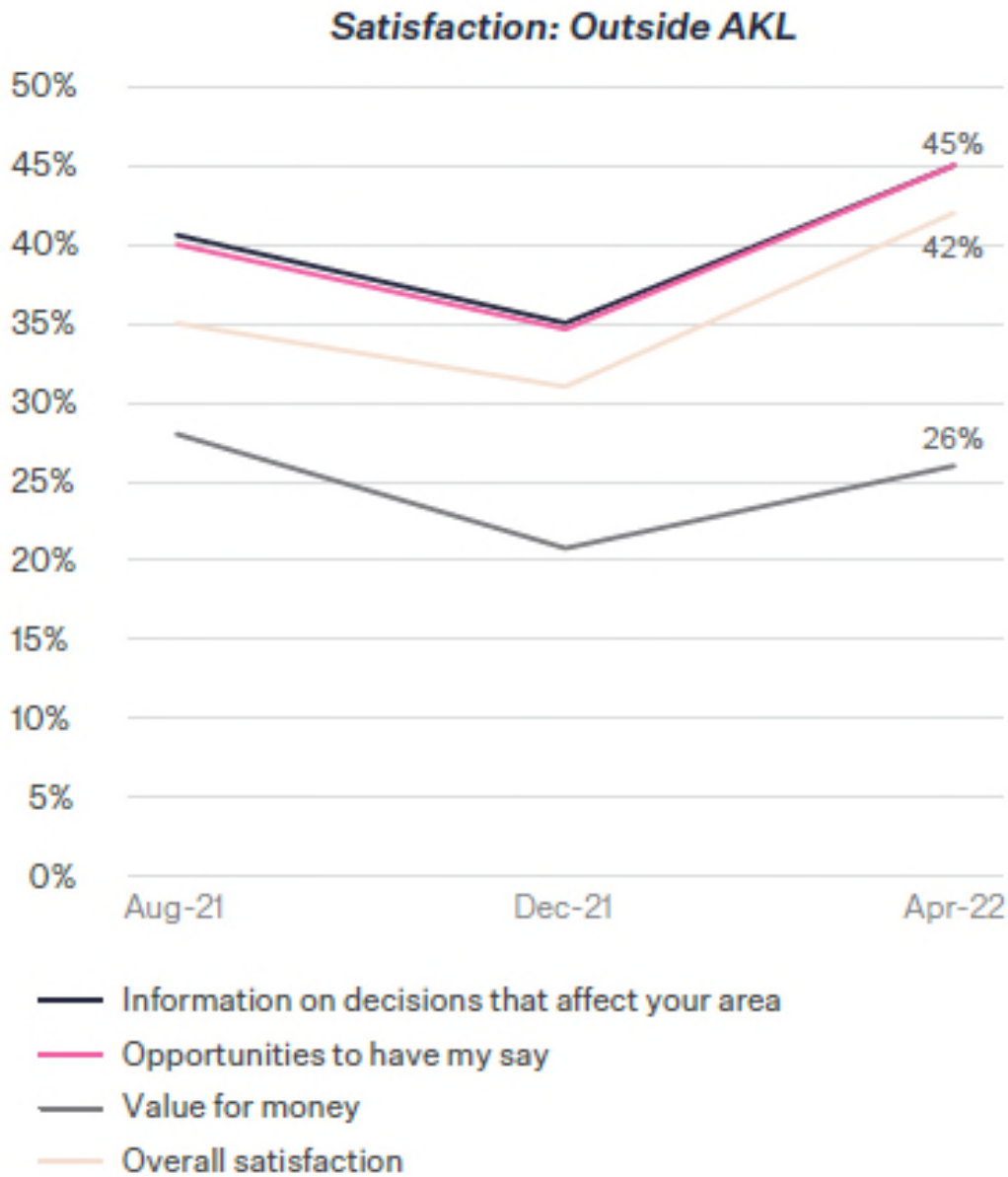

Research First Limited, Perceptions of Local Government May 2022

3.3. The following table compares the results of the 2022 and 2020 surveys. Due to the change in research companies and differences in methodology the data is not fully comparable.

	2022		2020	
	Used the service	Satisfied*	Used the service	Satisfied^
Dogs and wandering stock	6%	29%	8%	64%
Parks and Reserves	70%	66%	71%	90%
Public Toilets	59%	63%	53%	80%
Library services	37%	91%	44%	99%
Hokitika Swimming Pool	23%	63%	-	-
Unsealed roads	83%	41%	81%	76%
Community Halls	37%	83%	45%	93%
Refuse and recycling	72%	72%	73%	88%
Environmental Health	5%	40%	8%	88%
Liquor Licensing	2%	70%	2%	85%
Building Consents	19%	46%	-	-
Customer Services Centre	34%	76%	66%	74%
	Responses	Perceive Westland to be safe		
Perception of public safety	92%	98%	-	98%
	Overall measures		-	
Understand how Council makes decisions	-	75%	-	77%
Satisfaction with Council involvement of the public in decision-making	-	29%	-	36%
Performance of Mayor and Councillors	-	44%	-	41% #
Overall reputation (quality of services, vision and leadership, trust, financial management)	-	40%	-	-
Overall value for money (payment arrangements fair and reasonable, property rates fair and reasonable)	-	30%	-	-
Overall satisfaction with Council Performance	-	45%	-	-
	*Using a scale 1 - 10 with satisfied being 7 - 10)		^Using a 4 step scale with satisfied being 'fairly satisfied' and 'very satisfied'	
			#Using a 6 step scale with satisfied being 'fairly good' and 'very good'	

3.4. The results of the 2022 survey show that people are less satisfied with Councils services than in 2020, and fewer of the people surveyed have actually used the services. Residents continue to have a good understanding of the way that Council makes decisions and regard the district to be safe. Users of the library and Community Halls are more satisfied with this service than users of other services.

Longform responses about library were generally positive with people finding the staff helpful and friendly and the range of resources acceptable. Negative comments related to restrictions introduced because of Covid-19. Many of the respondents who do not use the library do not do so because they do not read books. This suggests more work could be done to improve awareness of the other services that the library offers.

Longform responses about the Community Halls identify some maintenance issues which could be why there is less satisfaction than in 2020. However, 64% of the responses commented that the halls were well maintained, clean and tidy.

- 3.5. Residents are least satisfied with the Animal Control activity and Unsealed roads. Fewer respondents had contact with Animal Control than in 2020 and more respondents used Unsealed Roads.

Longform responses to Animal control focussed on poor service from the ranger and issues of wandering stock. A new ranger was appointed late in 2021 and public perception of the service may change over time.

Longform responses to Unsealed roads were mixed. 31% believed the roads to be in good condition and graded regularly, but 33% commented on potholes on the roads. Other respondents commented that roads needed grading, were corrugated, needed sealing and were not wide enough.

- 3.6. The Survey report contains an analysis of the opportunities and priorities that Council can consider based on the results of the feedback:

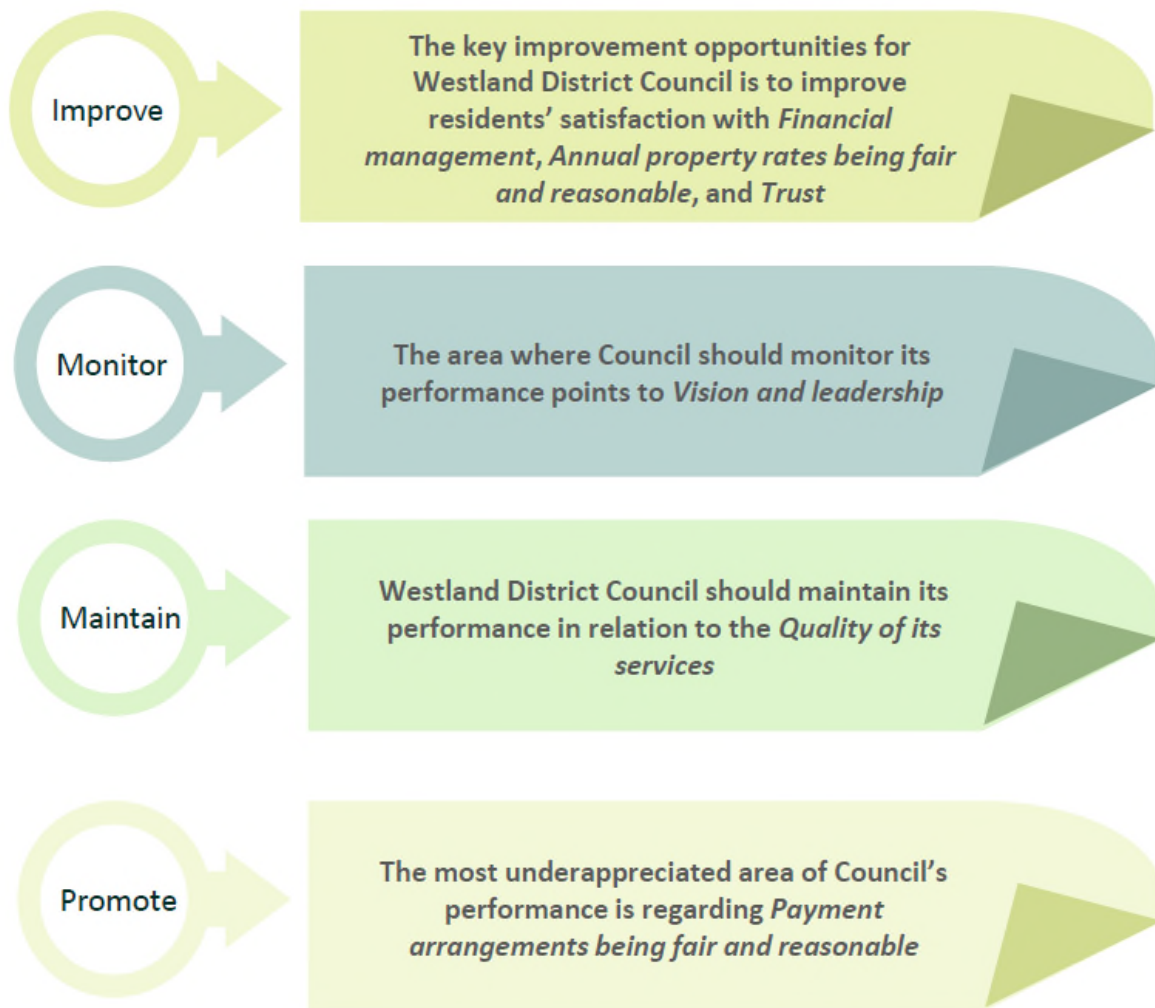

4. Options

- 4.1. Option 1: Council receives the report and attached appendices and directs staff to make Appendix 1 and 2 available on the Council website.
- 4.2. Option 2: Council receives the report and attached appendices but does not make them available to the public.
- 4.3. Option 3: Council does not receive the report and attached appendices and does not direct staff to make Appendix 1 and 2 available on the Council website.

5. Risk Analysis

- 5.1. Risk has been considered and the following risks have been identified:
 - 5.1.1. Compliance risk – If Council does not receive the report there is a risk that the 2021/2022 Annual Report will be non-compliant with the legislation, as many of the performance indicators rely on the results of the Survey and they have been identified in the Audit Management Report as requiring current data.
 - 5.1.2. Reputational risk – If Council does not make the results public then residents who have completed the survey may think that Council has wasted their time and ratepayers money in undertaking the Survey.

6. Health and Safety

- 6.1. Health and Safety has been considered and no items have been identified.

7. Significance and Engagement

- 7.1. The level of significance has been assessed as being administrative in nature. There are no decisions that affect the community. There will be public interest in the results of the Survey.
 - 7.1.1. No public consultation is considered necessary.

8. Assessment of Options (including Financial Considerations)

- 8.1. **Option 1** – That Council receives the 2022 Residents' Satisfaction Survey Results and makes them available to the public. The survey provides valuable information to staff and the public about how Council and its services are perceived and where there are opportunities for improvement.
 - 8.1.1. There are no financial implications to this option.
- 8.2. **Option 2** – That Council receives the 2022 Residents' Satisfaction Survey Results but does not make them available to the public. The information would be used by staff to understand the public perception of Council and its services, but would not be available to the public. Choosing not to release the results would increase the risk to Council's reputation and likely enforce any poor perception that the public has about Council's transparency and communications.
 - 8.2.1. There are no financial implications to this option.
- 8.3. **Option 3** – That Council does not receive the 2022 Residents' Satisfaction Survey Results and does not make them available to the public. This option means that staff may not have the information needed to make improvements to services that can enhance public perception. Staff would be unable to rely on the results needed to complete the 2021/2022 Annual Report with current data about resident satisfaction. As noted in Option 2, not releasing the results increases the risk to Council's reputation.

9. Preferred Option(s) and Reasons

- 9.1. The preferred option is **Option 1**.

9.2. The reason that Option 1 has been identified as the preferred option is that this would allow staff to review and implement necessary changes to improve the public perception of Council and its services. Staff would also be able to use the information to ensure a legislatively compliant 2021/2022 Annual Report.

9.3. It is important that this information is shared with the public, so that Council is transparent in its interactions with residents and allows people to understand how they can contribute to the democratic process.

10. Recommendation(s)

10.1. That the report be received.

10.2. That Council receives the 2022 Residents' Satisfaction Survey Results and instructs staff to make them available to the public.

Emma Rae
Strategy and Communications Advisor

Appendix 1: 2022 Westland District Council Residents' Satisfaction Survey

Appendix 2: Key Research - Westland DC Residents Survey 2022 - Verbatim Report 01042022



2022

Westland District Council Residents' Satisfaction Survey

Table of contents

- 3** Background, objectives and methodology
- 4** Executive summary
- 7** Overall satisfaction and other key performance measures
- 13** Services and facilities
- 24** Contact with Council and Customer Services Centre
- 30** Council consultation and community involvement
- 32** Drivers of perceptions
- 35** Public safety
- 37** General comments
- 39** Sample profile
- 42** Appendix A – Results by key demographics

Background, objectives and methodology

Background

The Westland District Council has an ongoing need to measure how satisfied residents are with the resources, facilities and services provided by Council, and to prioritise improvement opportunities that will be valued by the community.

Research objectives

- To provide a robust measure of satisfaction with Council's performance in relation to service delivery.
- To establish perceptions of various services, infrastructure and facilities provided by Council.
- To provide insights into how Council can best invest its resources to improve residents' satisfaction with its overall performance.

Method

- A mixed method approach to data collection was used, consisting of the following:
 - Residents from within the Westland District aged 18 years or older were randomly selected from the Electoral Roll to partake in the survey. Postcard invitations that contain the online survey link as well as paper survey questionnaires were sent out.
 - Telephone interviewing was also conducted using a Computer-Aided Telephone Survey (CATI) platform. Landline and mobile contacts were used.
- The survey generated a total sample of n=365 residents (123 residents via the postal to online method and 242 residents via telephone interviewing) across the Westland District.
- Responses to the survey were received from 11 February 2022 to 29 March 2022.
- At an aggregate level the survey has an expected confidence interval at the 95% level (margin of error) of +/-4.99%.
- Quota targets were monitored to ensure a sufficient sample by key demographic features including age, ward, gender and ethnicity.
- Post survey, the data has been weighted to the 2018 Census data to ensure the sample is representative of known population distributions within the region.

Notes

Due to rounding, figures may add to just under/over (+/- 1%) 100%.



Executive summary

Key findings

1

More than four in ten residents (45%) are satisfied with Westland District Council’s *Overall performance* (scoring 7 to 10 out of 10). The *Performance of the Mayor and Councillors* and *Overall reputation* have slightly lower satisfaction scores of 44% and 40% respectively. Amongst the overall measures, residents are likely to be least satisfied with *Value for money* (30%) and *Council consultation and community involvement* (29%).

2

Regarding *Image and reputation*, residents are most satisfied with the *Quality of services* provided by Council (56%) and least satisfied with *Financial management* (22%). Perception of Council in terms of the *Trust* residents have in them is significantly more positive amongst Northern ward residents than residents in the other wards.

3

Most residents are satisfied with several services and facilities provided by Westland District Council with *Library services* having the highest satisfaction rating of 91%, followed by the *Standard of the community halls* (83%). There is an opportunity to improve perceptions of the *Standard and safety of unsealed roads* with only 41% of road users satisfied.

4

Only a few residents have contacted Council regarding *Environment health* and *Liquor licensing* and *Building consent* matters in the past year. At least a third of the respondents (34%) have contacted the *Customer Services Centre* where more than three quarters (76%) were satisfied with the service they received.

5

Three in four residents (75%) *understand Westland District Council’s decision-making processes*. Just under three in ten residents (29%) are satisfied with the way the *Council involves the public in the decisions it makes*.

6

Overall reputation drives the perceptions of Westland District Council’s *Overall performance*. Bringing together the reputation and value for money attributes, the key priority for Council going forward is to improve perceptions around *Financial management*, *Trust* and *Annual property rates being fair and reasonable* while maintaining its performance in terms of *Quality of services*.

7

Nearly all residents (98%) perceive the Westland District as a *Safe place to live*. Some of the comments about public safety pertain to Westland District being *Generally safe with a good community* (57%).

Summary of key performance indicators

OVERALL MEASURES

Satisfied (%7-10)

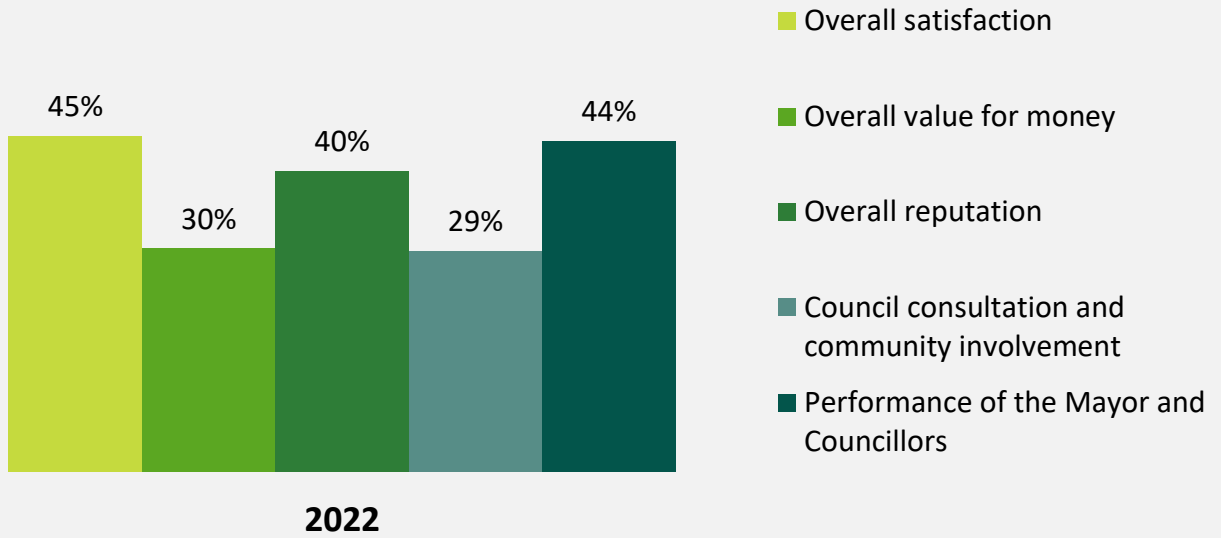

REPUTATION

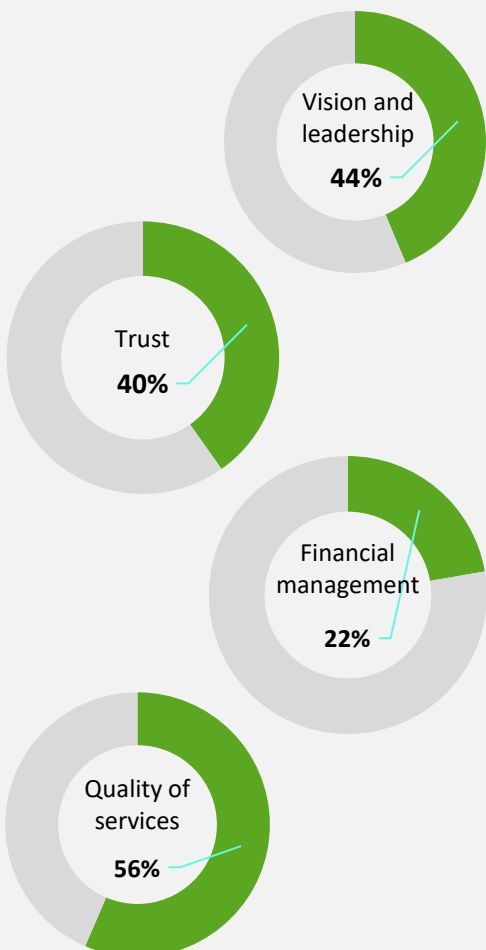

SERVICES AND FACILITIES

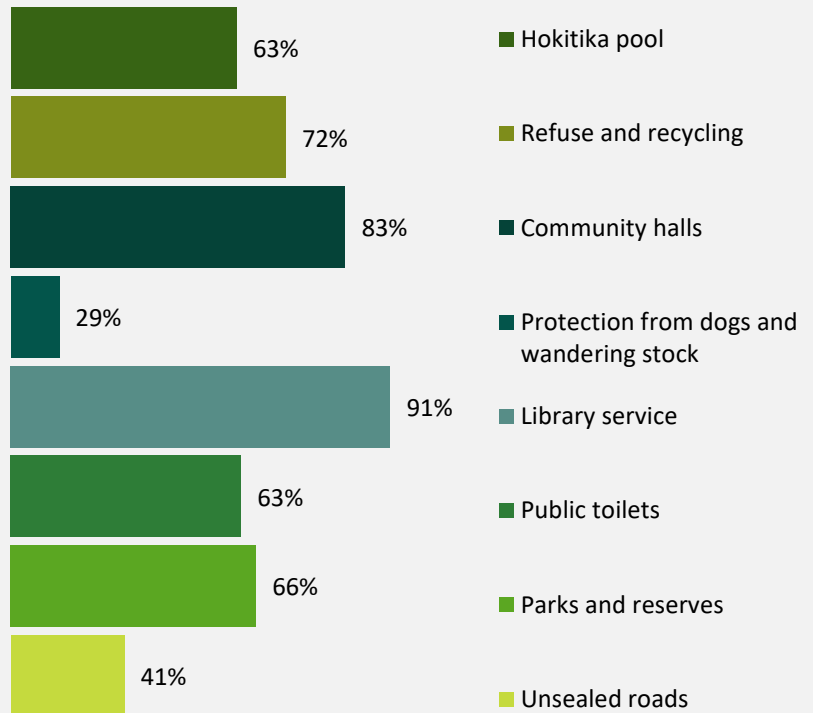



Overall satisfaction and other key performance measures

Overall satisfaction with Westland District Council’s performance

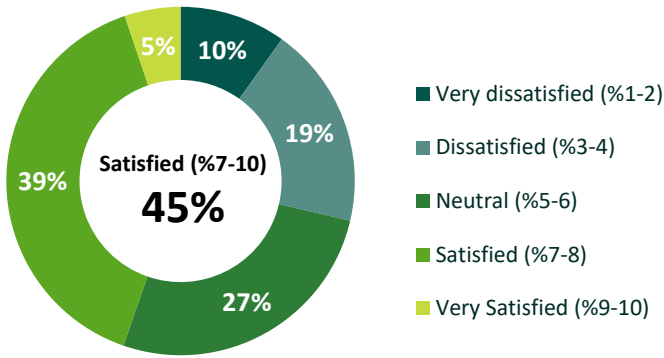

More than two in five residents (45%) are satisfied with the *Overall performance* of Westland District Council.

Overall satisfaction amongst Northern ward residents is significantly higher than the satisfaction amongst residents in the Southern ward.

Satisfaction by demographic groups (%7-10)

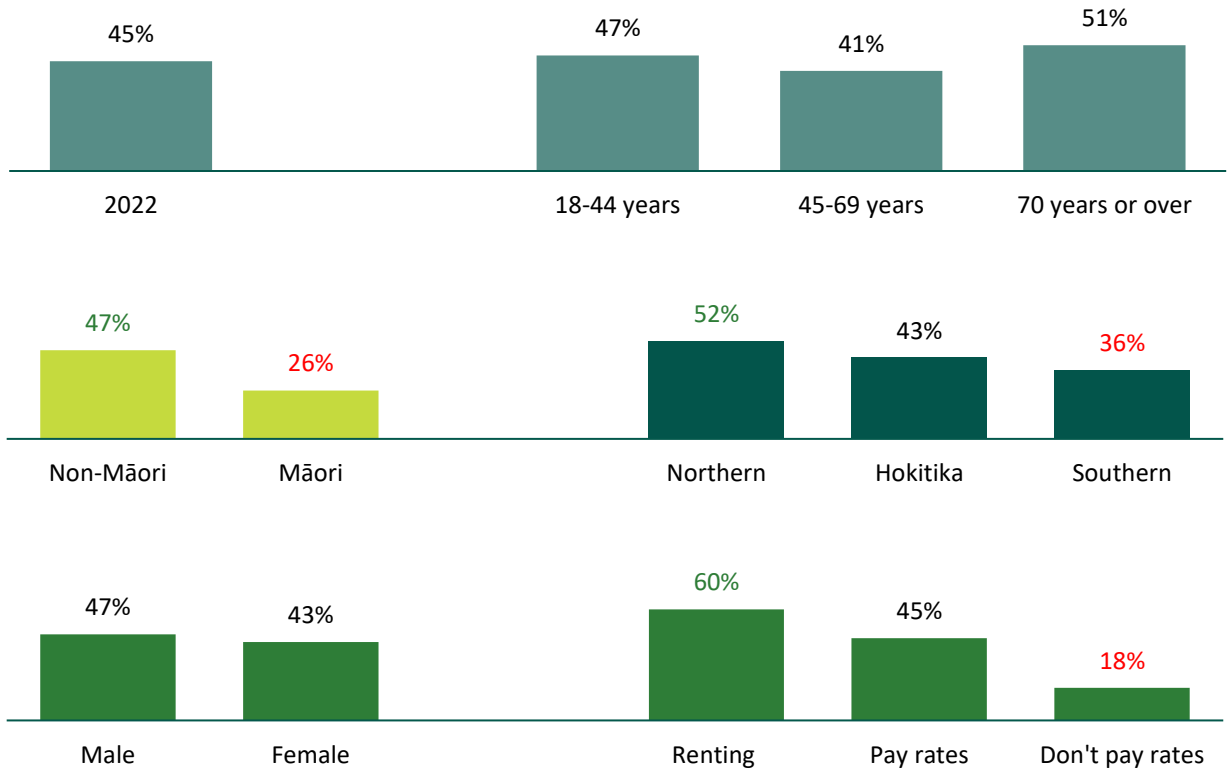

Significantly higher than the other demographic group(s)
 Significantly lower than the other demographic group(s)

NOTES:

- Sample: 2022 n=365; Excludes 'Don't know' responses
- 18-44 n=54; 45-69 n=180; 70+ n=113
- Male n=162; Female n=185
- Māori n=26; Non-Māori n=321
- Northern n=73; Hokitika n=197; Southern n=77
- Renting n=12; Pay rates n=326; Don't pay rates n=9
- Q51. Thinking about Council overall, their image and reputation, the services, and facilities they provide and the rates and fees that you pay, how satisfied are you with the Westland District Council? n=347

Overall measures

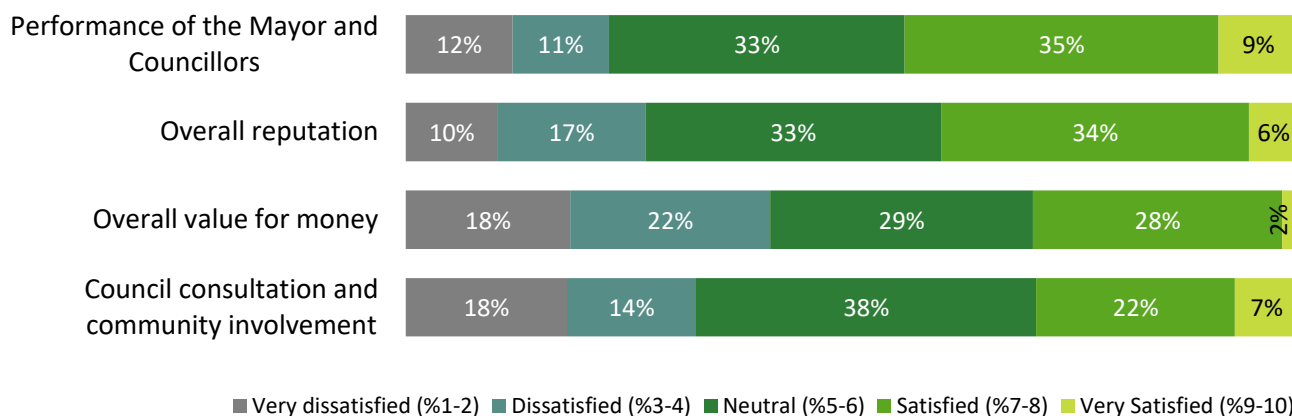

Satisfaction Scores (% 7-10)	2022			
	18 to 44 years	45 to 69 years	70 years and over	
Performance of the Mayor and Councillors	44%	38%	52%	
Overall reputation	40%	35%	45%	
Overall value for money	30%	33%	37%	
Council consultation and community involvement	29%	27%	35%	

Satisfaction Scores (% 7-10)	2022		
	Northern	Hokitika	Southern
Performance of the Mayor and Councillors	42%	42%	49%
Overall reputation	42%	41%	36%
Overall value for money	33%	25%	31%
Council consultation and community involvement	34%	27%	26%

Satisfaction with the *Performance of the Mayor and Councillors* is highest amongst older and Southern ward residents. Fewer than three in ten residents (29%) are satisfied with *Council consultation and community involvement*. Younger and Hokitika ward residents are the least satisfied with *Overall value for money*. Northern ward and Hokitika ward residents have more favourable perceptions of Council's *Overall reputation* than Southern ward residents.

NOTES:

1. Sample: 2022 n=365; Excludes 'Don't know' responses
2. Q44. Thinking about everything Westland District Council has done over the past twelve months and what you have experienced of its services and facilities, how satisfied are you with how rates are spent on services and facilities provided by Council and the value for money you get for your rates?
3. Q50. Everything considered – leadership, trust, financial management and quality of services provided, how would you rate Westland District Council for its overall reputation?
4. Q40. Using a scale of 1 to 10 where 1 is 'very dissatisfied' and 10 is 'very satisfied', how satisfied are you with the way your Council involves the public in the decision making process? **26 May 2022 Westland District Council Meeting Agenda**
5. Q37. Using a slightly different scale of 1 to 10 where 1 is 'poor' and 10 is 'very good', how would you rate the performance of the Mayor and Councillors overall in the last year?

Performance of the Mayor and Councillors

Reasons for score given

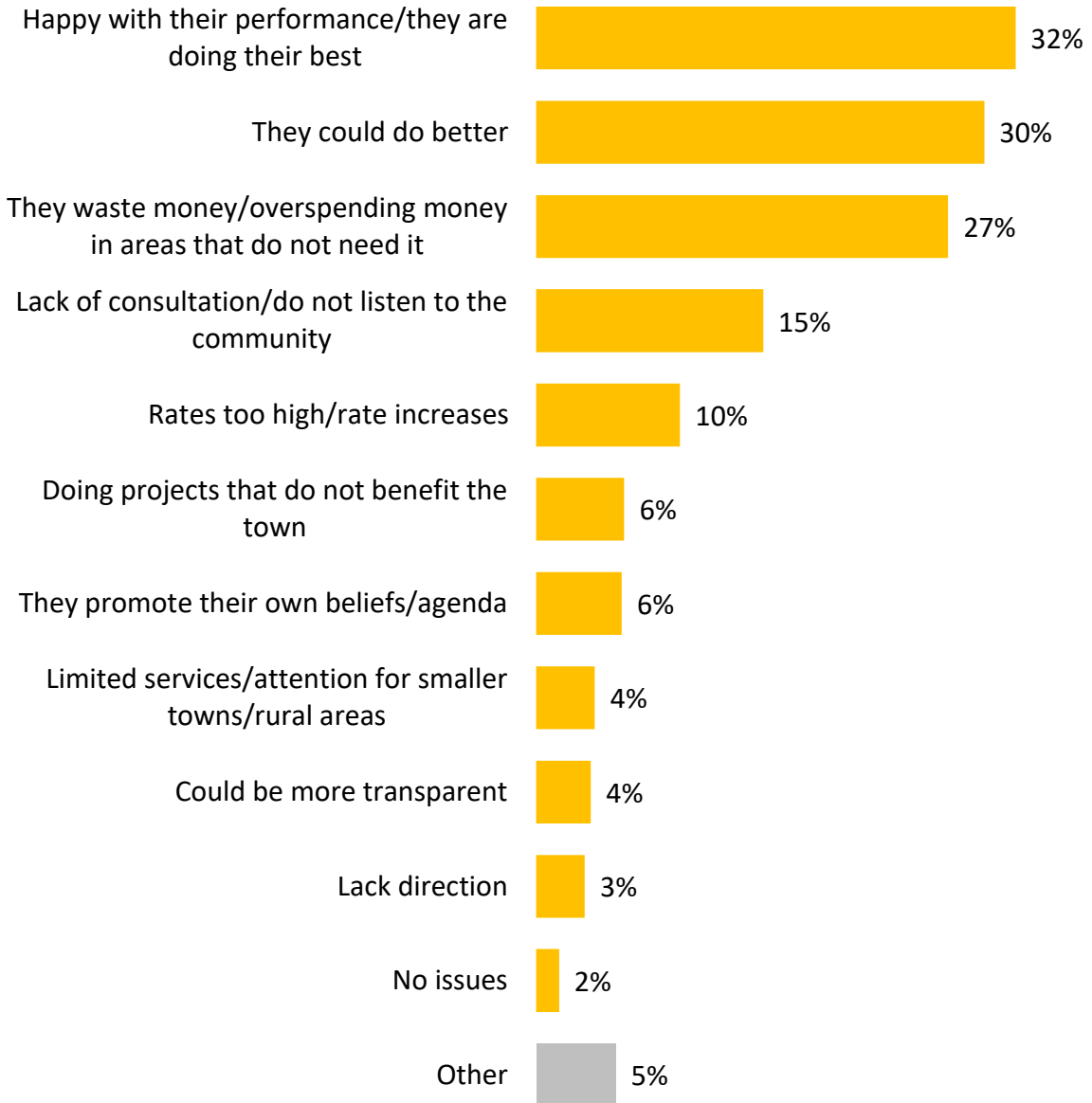

Nearly one third of residents (32%) who provided a reason for their rating of the Performance of the Mayor and Councillors have indicated that they are *happy with their performance* while three in ten (30%) think that *they could do better*. More than a quarter (27%) mentioned that the elected members *waste money/overspending money in areas that do not need it*.

NOTES:

1. Sample: 2022 n=365; Excludes 'Don't know' responses
2. Q37. Using a slightly different scale of 1 to 10 where 1 is 'poor' and 10 is 'very good' and taking all aspects into account, how would you rate the performance of the Mayor and Councillors over all in the last year?
3. Q38. Could you please tell us why you gave that rating? n=317

Image and reputation

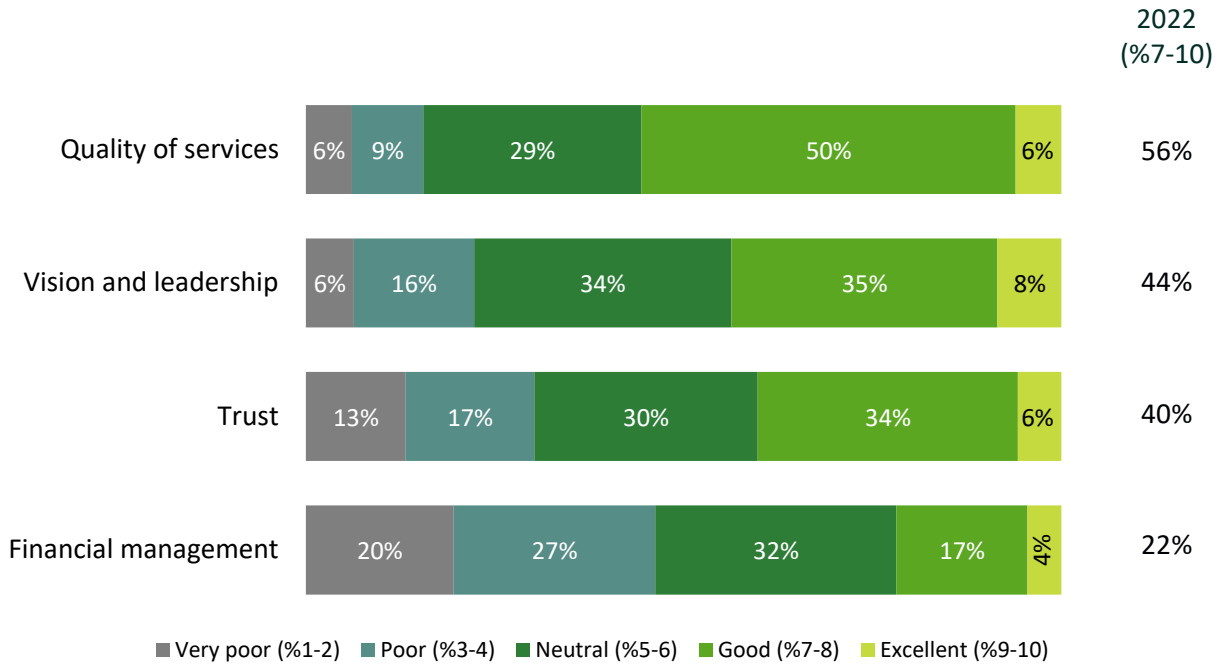

Scores with % 7-10	2022			
	Northern	Hokitika	Southern	
Quality of services	62%	50%	53%	56%
Vision and leadership	47%	39%	44%	44%
Trust	51%	34%	33%	40%
Financial management	17%	21%	30%	22%

Amongst the attributes of Council’s image and reputation, *Quality of services* has been rated the highest with more than half of the residents (56%) providing a score of 7 to 10 out of 10 while *Financial management* received the lowest score (22%). Perception of Council in terms of the *Trust* residents have in them is significantly more positive amongst Northern ward residents than residents in the Hokitika and Southern wards.

Significantly higher than the other ward(s)
Significantly lower than the other ward(s)

NOTES:

- Sample: 2022 n=365; Excludes ‘Don’t know’ responses
- Q46. Using a rating scale of 1 to 10 where 1 is ‘very poor’ and 10 is ‘excellent’, how would you rate the Council for being committed to creating a great District, how it promotes economic development, being in touch with the community and setting clear direction?
- Q47. Thinking about how open and transparent Council is, how Council can be relied on to act honestly and fairly, and their ability to work in the best interests of the District, overall, how would you rate the Council in terms of the faith and trust you have in them?
- Q48. Thinking about the Council’s financial management, how appropriately it invests in the District, how wisely it spends and avoids waste, and its transparency around spending, how would you rate the Council overall for its financial management?
- Q49. When you think about everything that Council does, how would you rate the Council for the quality of the services and facilities they provide Westland District Council Meeting Agenda
- Q50. Everything considered – leadership, trust, financial management and quality of services provided, how would you rate Westland District Council for its overall reputation?

Value for money

2022
(%7-10)

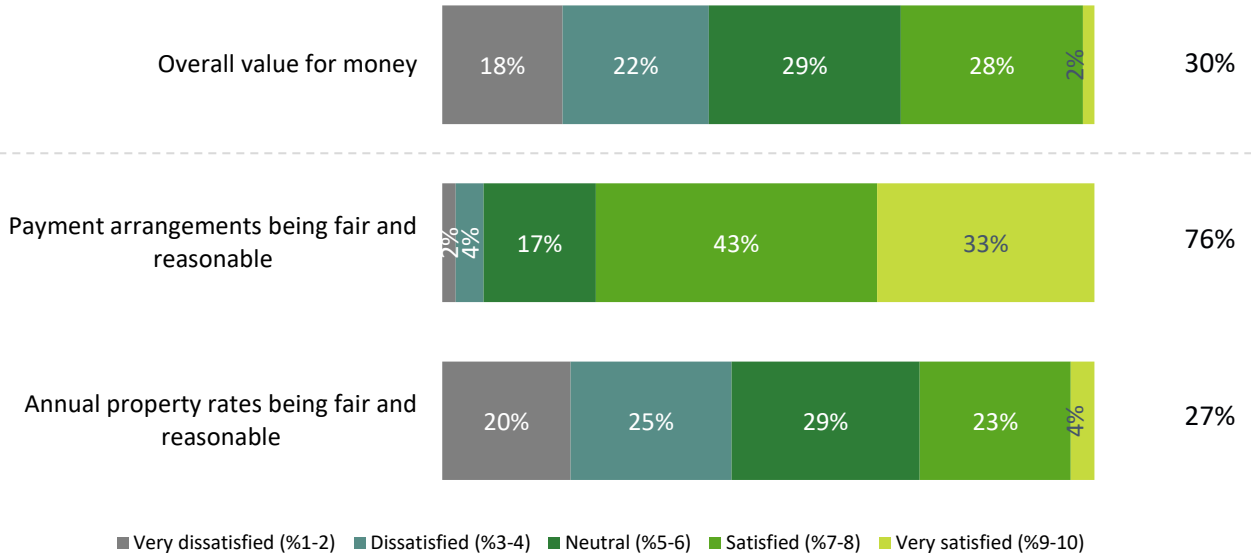

Scores with % 7-10	2022			
	2022	Northern	Hokitika	Southern
Overall value for money	30%	33%	25%	31%
Payment arrangements being fair and reasonable	76%	81%	72%	76%
Annual property rates being fair and reasonable	27%	28%	21%	32%

Regarding *Value for money*, more than three quarters of the residents (76%) are satisfied with *Payment arrangements being fair and reasonable*. On the other hand, less than three in ten residents (27%) are satisfied with *Annual property rates being fair and reasonable* with residents of the Northern and Southern wards being more satisfied than Hokitika ward residents.

NOTES:

- Sample: 2022 n=365; Excludes 'Don't know' responses
- Q46. Using a rating scale of 1 to 10 where 1 is 'very poor' and 10 is 'excellent', how would you rate the Council for being committed to creating a great District, how it promotes economic development, being in touch with the community and setting clear direction?
- Q47. Thinking about how open and transparent Council is, how Council can be relied on to act honestly and fairly, and their ability to work in the best interests of the District, overall, how would you rate the Council in terms of the faith and trust you have in them?
- Q48. Thinking about the Council's financial management, how appropriately it invests in the District, how wisely it spends and avoids waste, and its transparency around spending, how would you rate the Council overall for its financial management?
- Q49. When you think about everything that Council does, how would you rate the Council for the quality of the services and facilities they provide Westland District Council Meeting Agenda
- Q50. Everything considered – leadership, trust, financial management and quality of services provided, how would you rate Westland District Council for its overall reputation?



Services and facilities

Protection provided from dogs and wandering stock

Have contacted Council

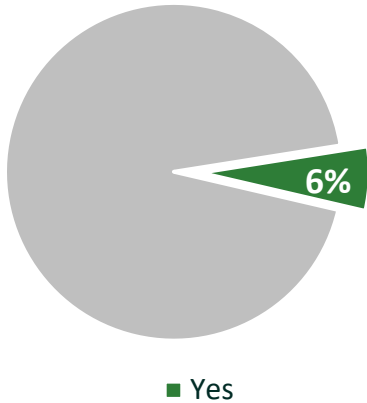

Overall satisfaction

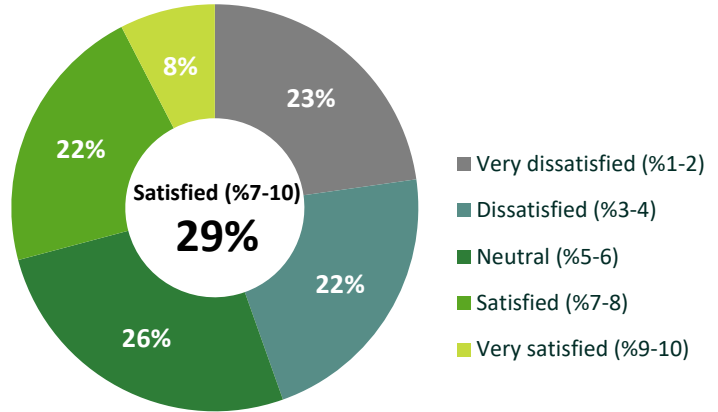

Reasons for score given

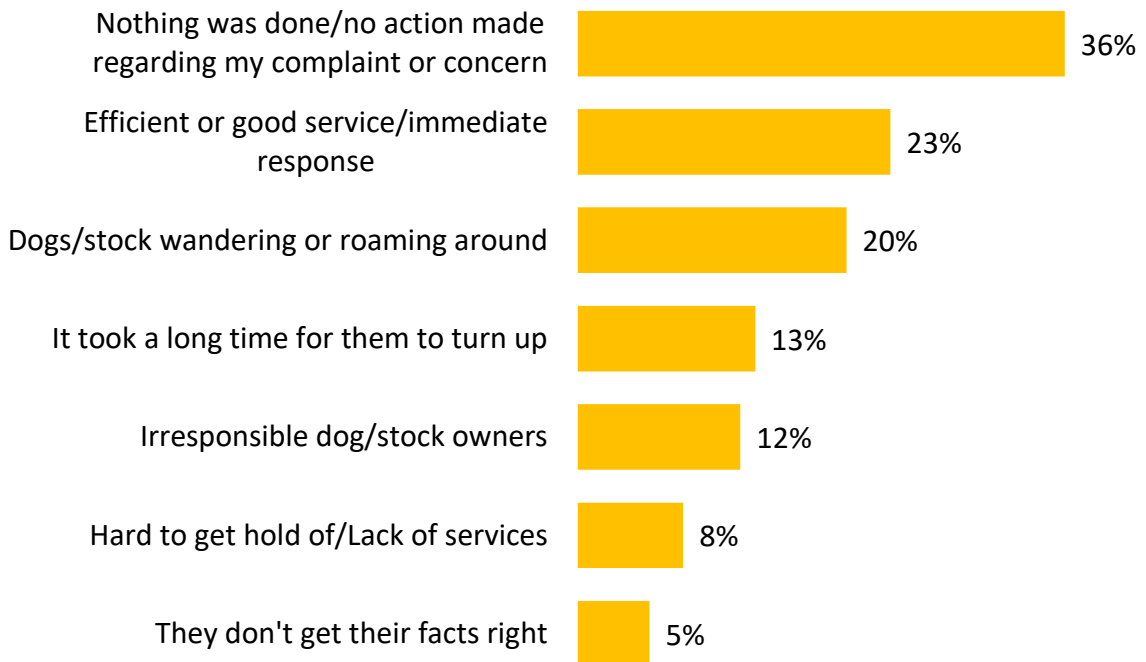

A few residents (6%) have contacted Council about *Dogs and wandering stock* in the past year. Out of this proportion, nearly three in ten (29%) are satisfied with the *Protection provided by Council from dogs and wandering stock*. More than one third (36%) of those who have provided a comment cited that *no action was done regarding their complaint/concern* while almost a quarter (23%) said that *Council had provided efficient or good service/immediate response*.

NOTES:

1. Sample: 2022 n=365; Excludes 'Don't know' responses
2. Q1. Have you contacted the Council about dogs and wandering stock in the last year? Yes n=24 (Caution: small sample size)
3. Q2. Using a rating scale of 1 to 10 where 1 is 'very dissatisfied' and 10 is 'very satisfied', how satisfied are you with the protection provided from dogs and wandering stock?
26 May 2022 Westland District Council Meeting Agenda Page 46
4. Q3. Could you please tell us why you feel that way? n=23 (Caution: small sample size)

Parks or reserves

Have used or visited a park or reserve in the last year

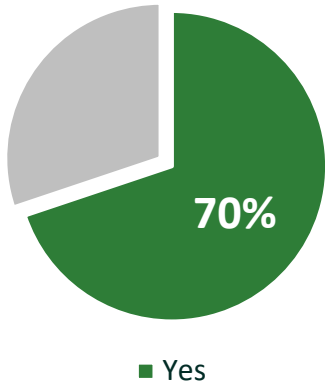

Overall satisfaction

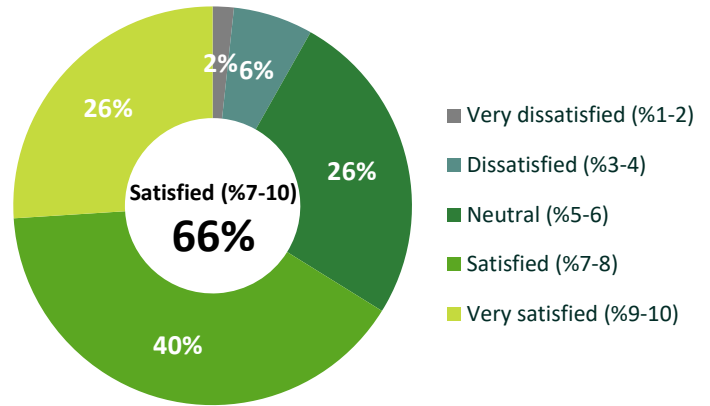

Reasons for score given

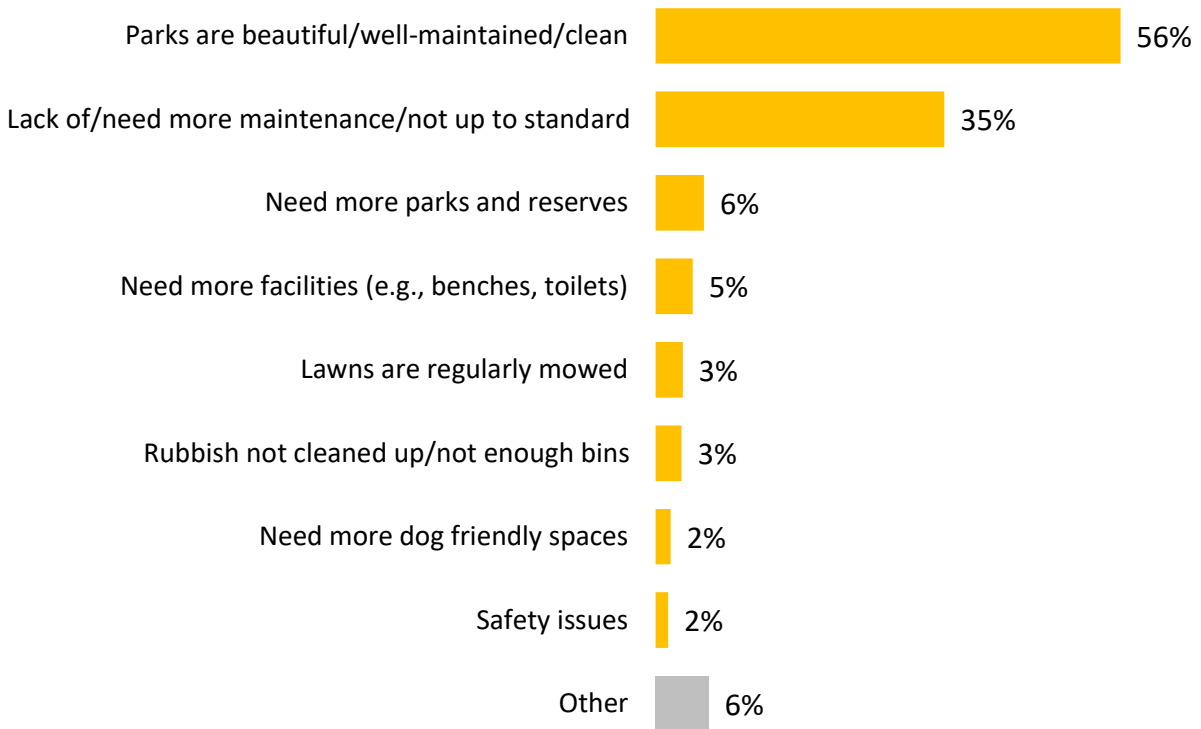

In the last twelve months, seven in ten residents (70%) have used or visited a *Park or reserve* in the district with two thirds of them (66%) satisfied with these open spaces. Residents think that parks in the district are *beautiful/well-maintained/clean* (56%) while a lesser proportion (35%) would like *more maintenance done* to these open spaces.

NOTES:
 1. Sample: 2022 n=365; Excludes 'Don't know' responses
 2. Q4. Have you used or visited, in the last year, a park or reserve in the District? Yes n=237
 3. Q5. Using the same 1-10 rating scale, District Council employees rate parks and reserves in the District?
 4. Q6. Could you please tell us why you feel that way? n=222; Items ≤1% are not shown.

Public toilets

Have used a public toilet in the last year

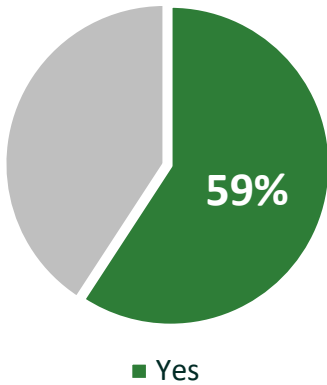

Overall satisfaction

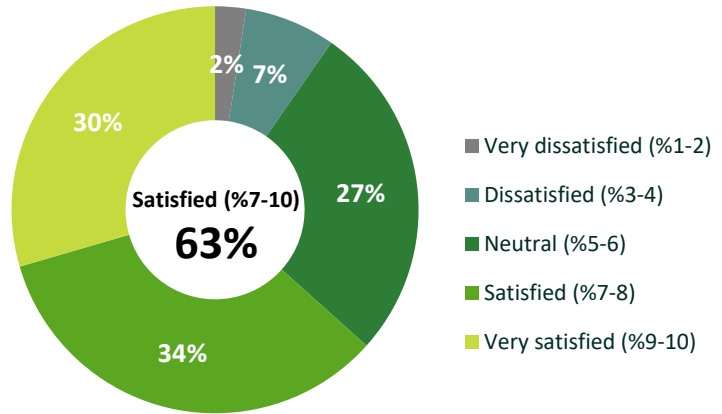

Reasons for score given

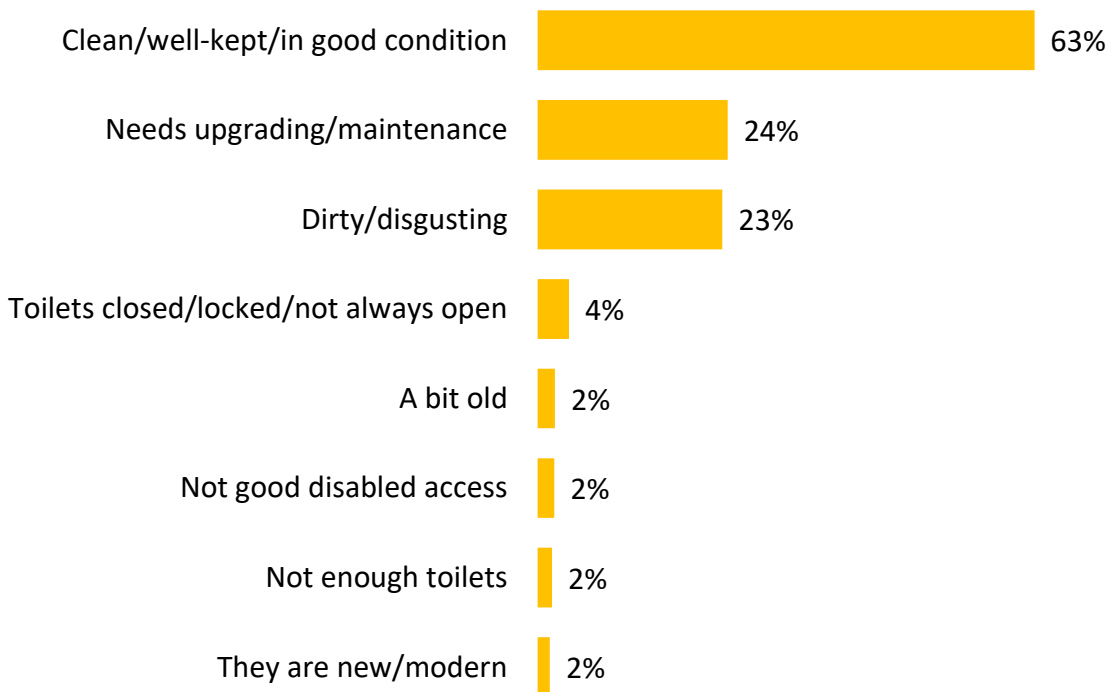

Almost three in five residents (59%) have used a *Public toilet* in the district in the last year. User satisfaction with these facilities is 63%. Most residents (63%) perceive the district's public toilets to be *clean/well-kept/in good condition*. Some residents think that these facilities *need upgrading/maintenance* (24%) and are *dirty/disgusting* (23%).

NOTES:

1. Sample: 2022 n=365; Excludes 'Don't know' responses
2. Q7. Have you used or visited a public toilet in the District? Yes n=200
3. Q8. How satisfied are you with the public toilets in the District? n=200
4. Q9. Could you please tell us why you feel that way? n=192; Items ≤1% are not shown.

Library services

Have used any library service in the last year

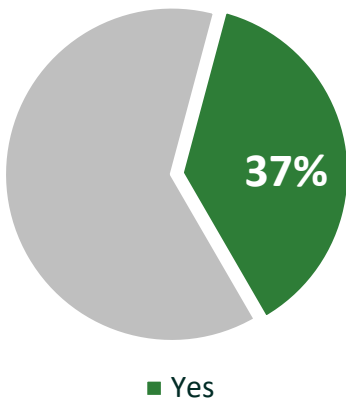

Overall satisfaction

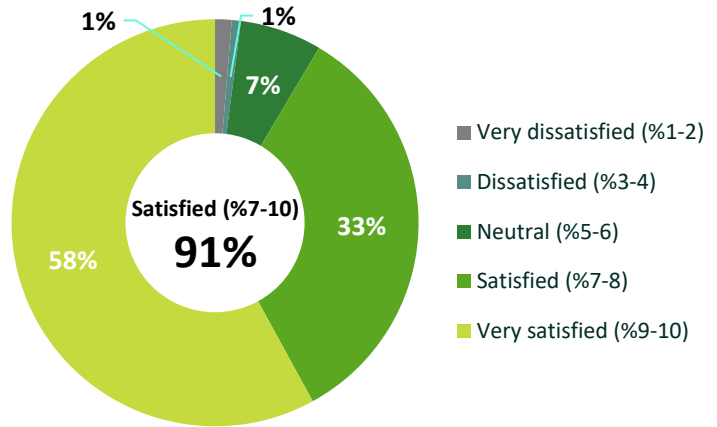

Reasons for score given

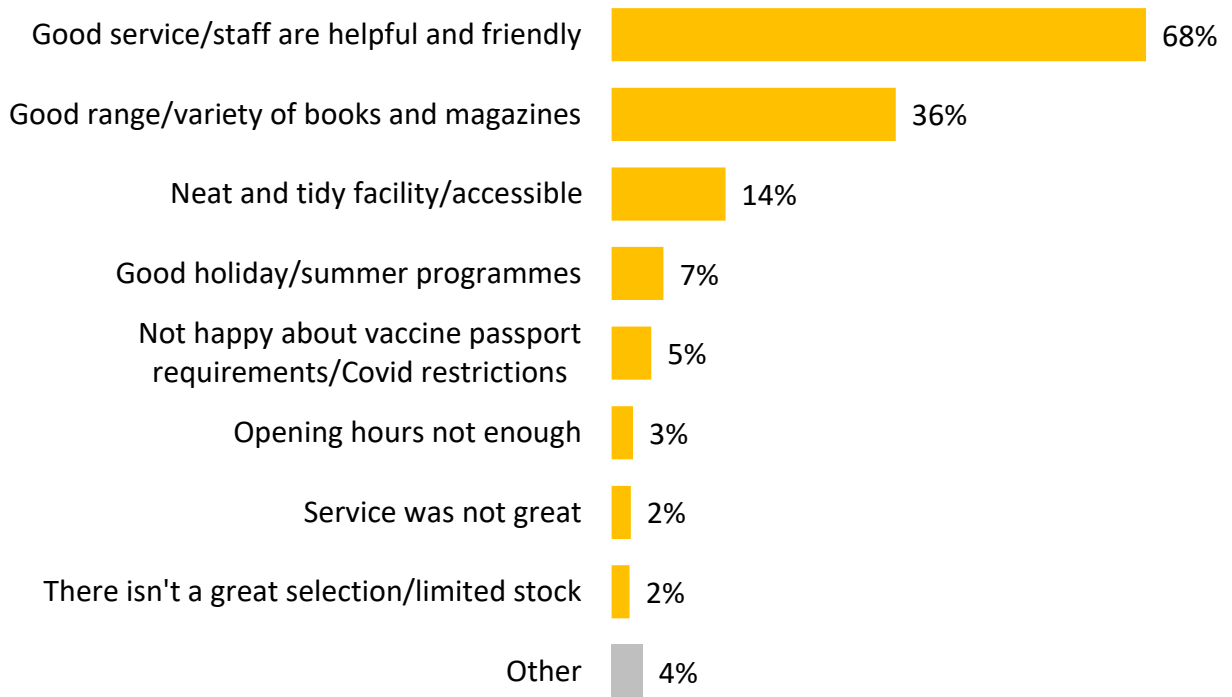

Almost four in ten residents (37%) have used a *Library service* in the district in the last year. Satisfaction with library services is high (91%). *Good service/staff helpfulness* is the main reason for the excellent rating, followed by a *good range/variety of books and magazines*. A few residents perceive the library as *neat, tidy and accessible*.

NOTES:

1. Sample: 2022 n=365; Excludes 'Don't know' responses
2. Q10. Have you used any Westland library service in the District in the last year? Yes n=138
3. Q11. How satisfied are you with library services in the District? n=138
4. Q12. Could you please tell us why you feel that way? n=125

Library services

Reasons for not using any library service

63%
Have not used any library service in the last year

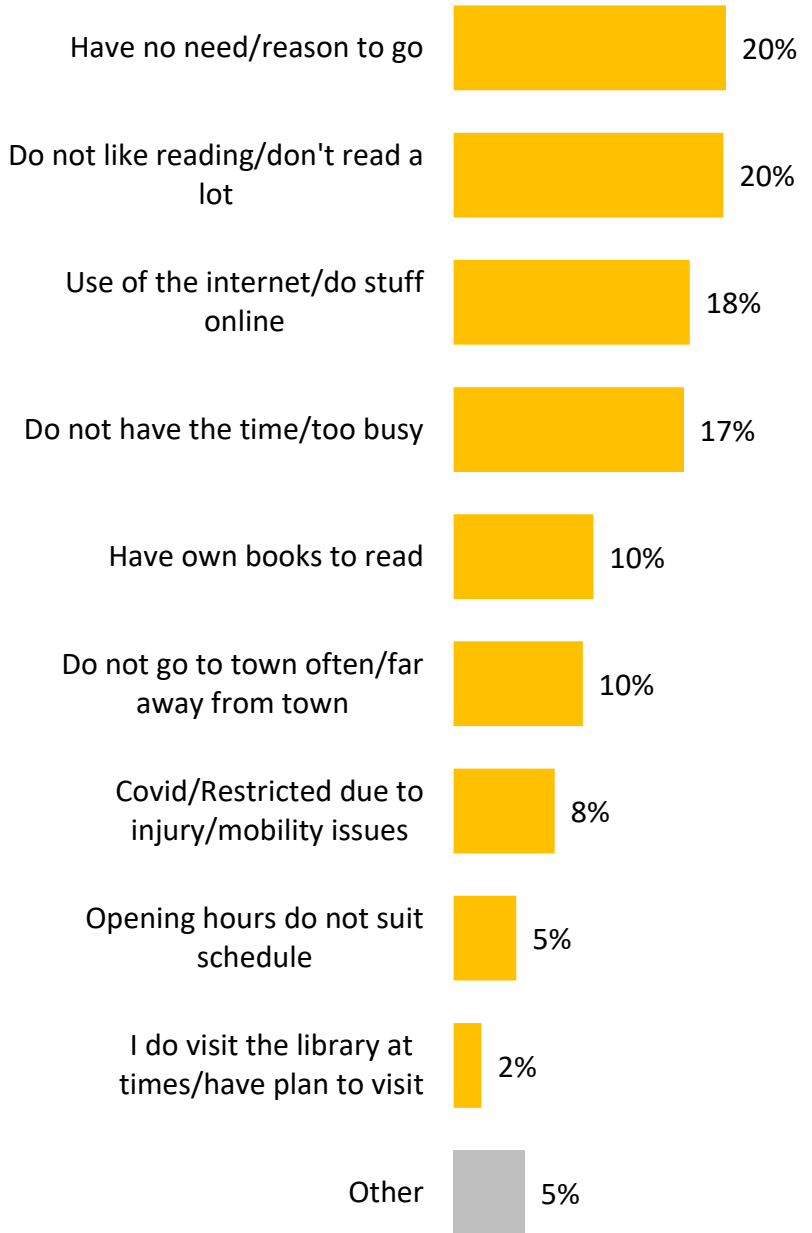

Out of those who have not used a library service in the District in the past year, 20% said they *have no reason to go to the library* and the same proportion *do not like reading*. *Internet use* and *not having the time to go to the library* have also been cited as reasons.

NOTES:

1. Sample: 2022 n=365; Excludes 'Don't know' responses
2. Q10. Have you used any Westland library service in the District in the last year? Yes n=138
3. Q13. Can you please tell us why you have not used any library service in the District in the last year? n=218; 10% are not shown.

Quality of swimming and exercise experience at the Hokitika pool

Have used the Hokitika pool in the last year

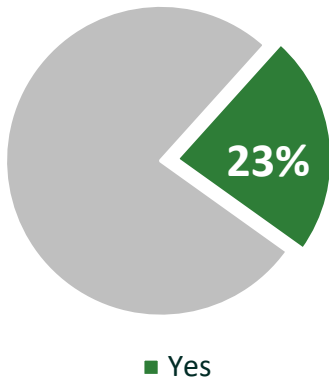

Overall satisfaction

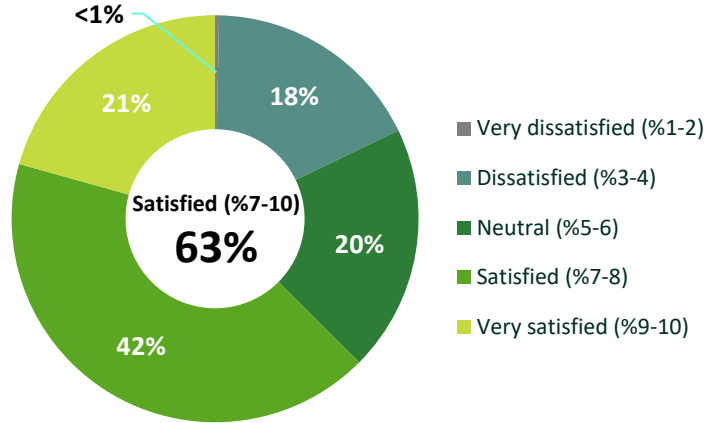

Reasons for score given

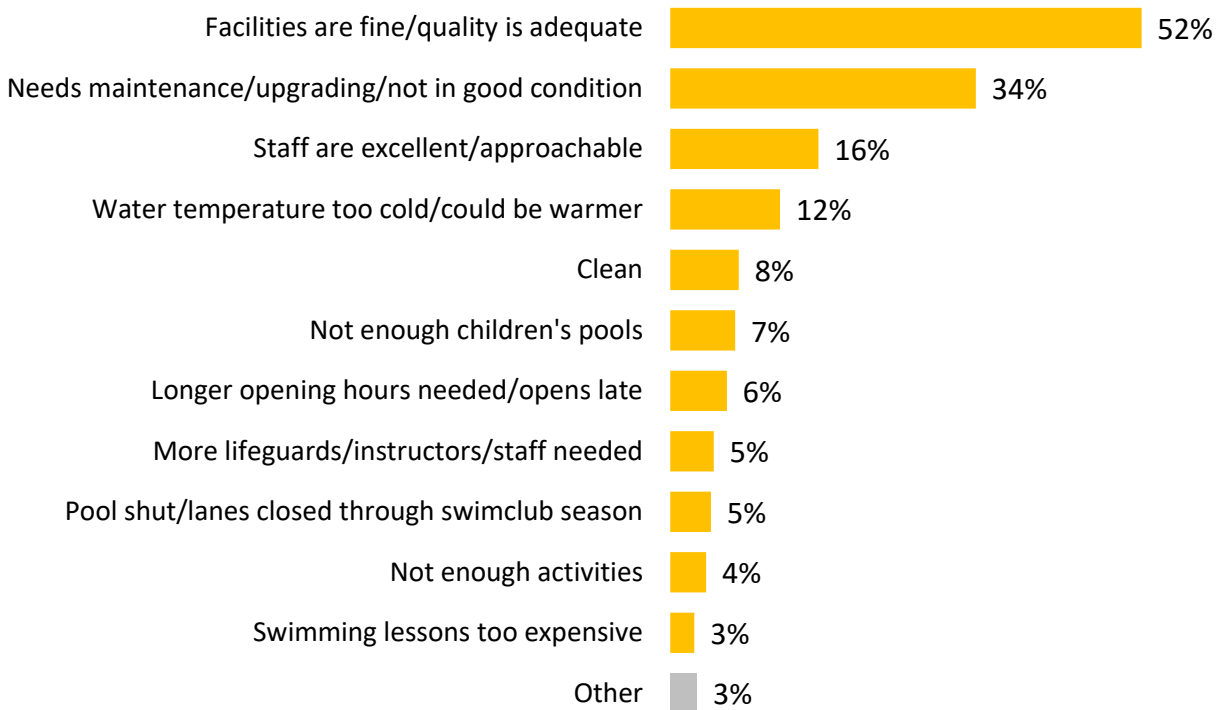

Twenty-three percent of residents have used the *Hokitika pool* in the last year and almost two in three users (63%) are satisfied with the facility. The most common comments made about the Hokitika pool refer to the *good facilities* (52%). Some users would like the pool to *undergo maintenance and upgrading* (34%).

NOTES:

1. Sample: 2022 n=365; Excludes 'Don't know' responses
2. Q14. Have you used the Hokitika pool in the last year? Yes n=61
3. Q15. Using the same 1-10 rating scale, how satisfied are you with the quality of swimming and exercise experience at the Hokitika pool? n=61
4. Q16. Could you please tell us why you feel that way? n=61; Items ≤1% are not shown.

Standard and safety of unsealed roads

Have used an unsealed road in the District in the last year

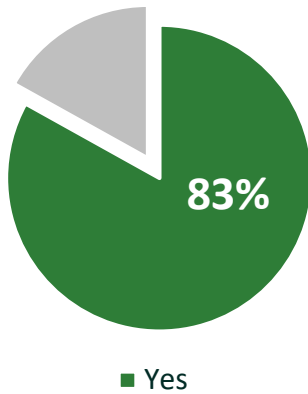

Overall satisfaction

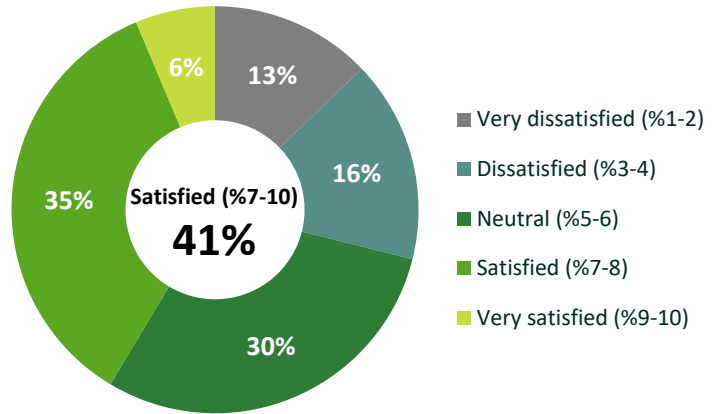

Reasons for score given

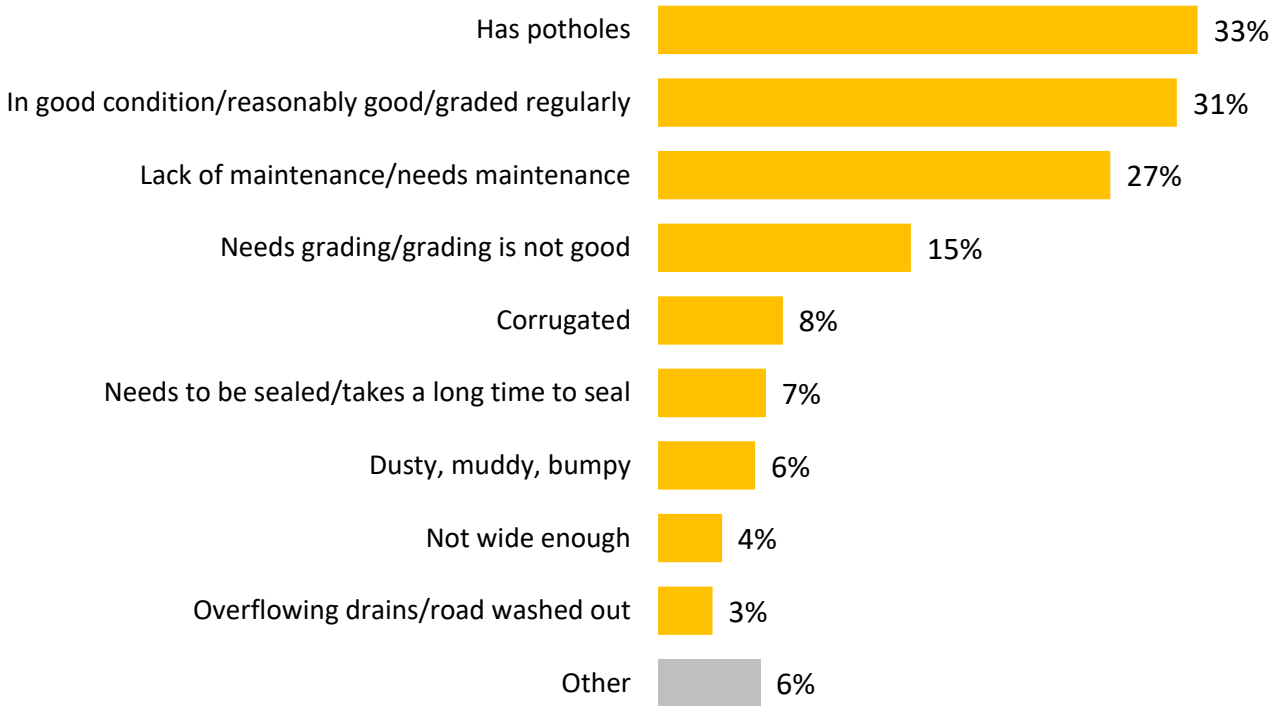

Most residents (83%) have used an *Unsealed district road* in the last year. Around two in five road users (41%) are satisfied with the *standard and safety of unsealed roads*. Residents have mentioned *roads having potholes, lacking maintenance and not being graded enough* as some of the reasons for their rating. More than three in ten residents (31%) think the roads are *in good condition/reasonably good*.

NOTES:

1. Sample: 2022 n=; Excludes 'Don't know' responses
2. Q17. In the last year, have you used an unsealed road in the District? Yes n=283
3. Q18. How satisfied have you been with the standard and safety of unsealed roads? **26 May 2022 Westland District Council Meeting Agenda**
4. Q19. Could you please tell us why you feel that way? n=270; Items ≤1% are not shown.

Standard of community halls

Have used a community hall in the last year

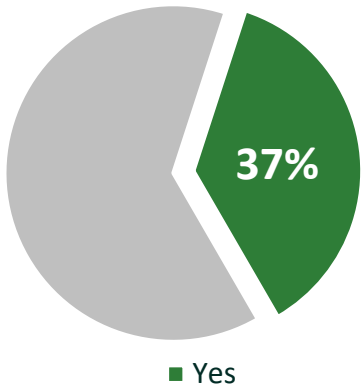

Overall satisfaction

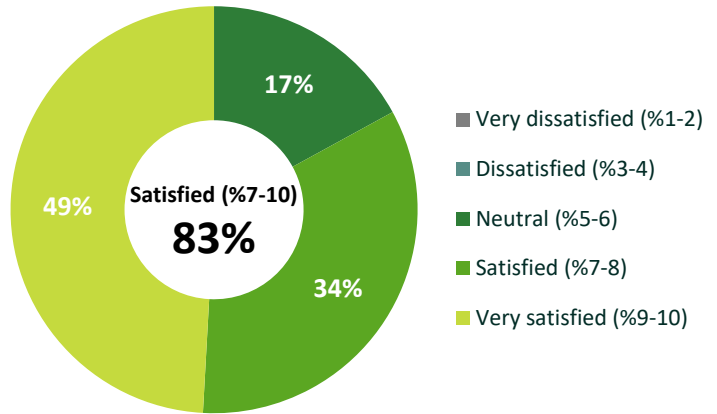

Reasons for score given

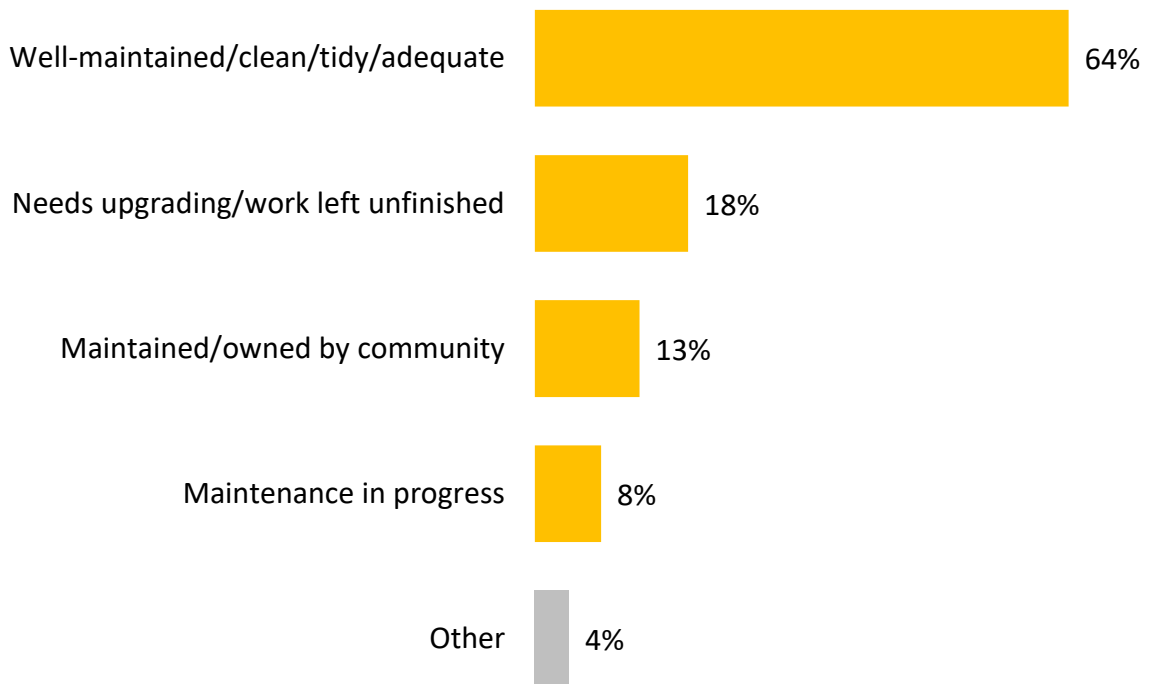

User satisfaction with the *Standard of community halls* is high (83%). Most users view the halls to be *well-maintained* while a few see the *need for an upgrade and maintenance work*.

NOTES:

1. Sample: 2022 n=365; Excludes 'Don't know' responses
2. Q20. In the last year, have you used a community hall in the District? Yes n=107
3. Q21. How satisfied are you with the standard of community halls? n=107
4. Q22. Could you please tell us why you feel that way? n=102; Items ≤1% are not shown.

Refuse and recycling collection service

Council provides a regular refuse and recycling collection service where you live

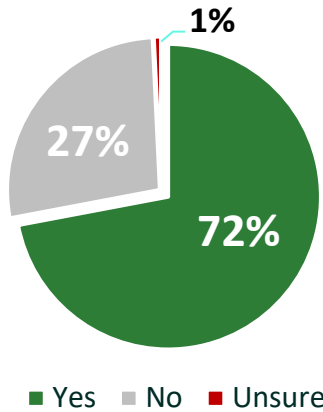

Overall satisfaction

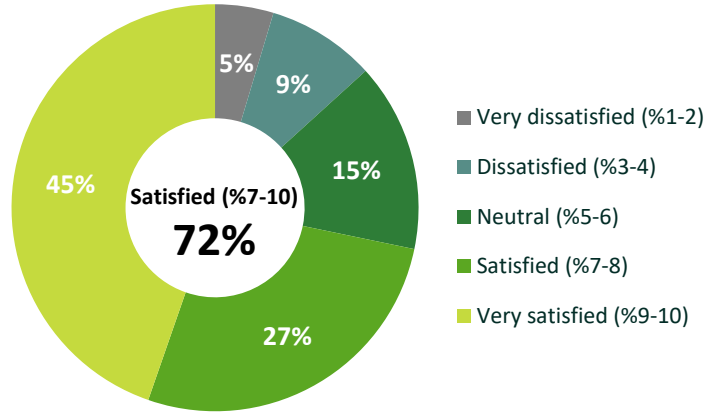

Reasons for score given

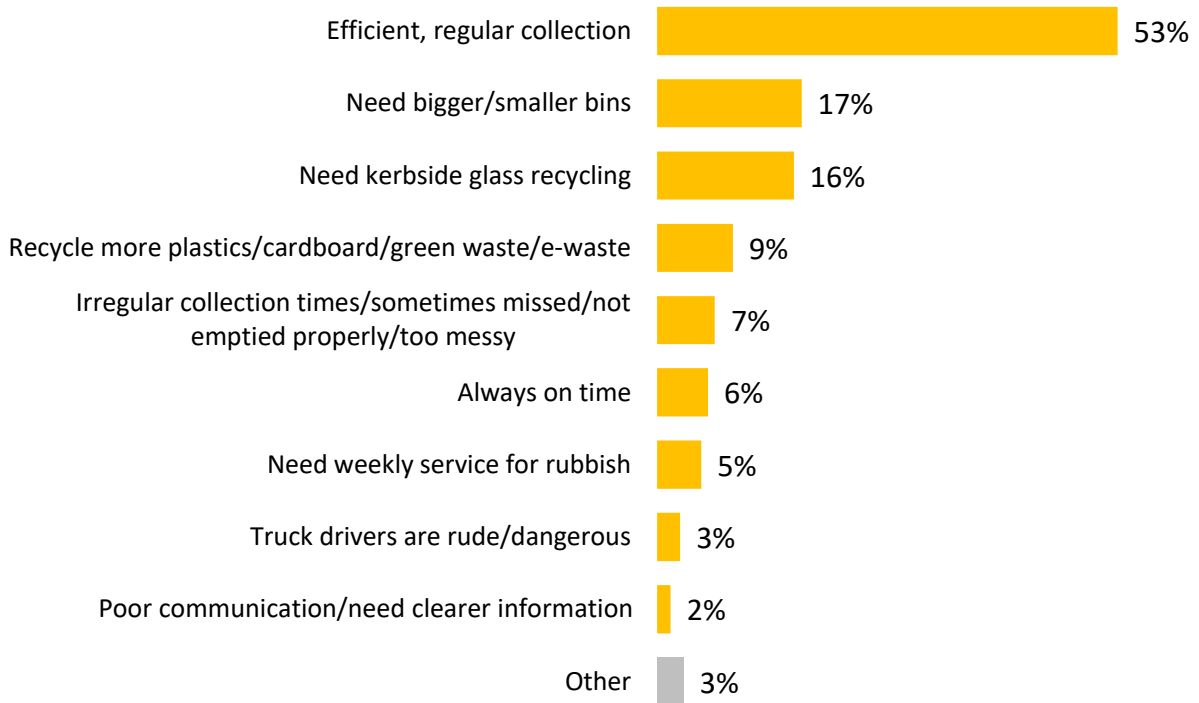

For most residents, Council provides a *Regular refuse and recycling collection service* in the place where they live. More than seven in ten residents (72%) who receive this service are satisfied with Council's performance in this area with *efficient/regular collection* (53%) as the top reason for their scores. The other comments refer to the *need for bigger/smaller bins* (17%), *kerbside glass recycling* (16%), and *more plastic, green waste and e-waste recycling* (16%).

NOTES:

1. Sample: 2022 n=365; Excludes 'Don't know' responses
2. Q23. Where you live, does the Council provide a regular refuse and recycling ? Yes n=296
3. Q24. How satisfied are you with the refuse and recycling collection service provided to each house? 26 May 2022 Westland District Council Meeting Agenda
4. Q25. Could you please tell us why you feel that way? n=281; Items ≤1% are not shown.

Services and facilities

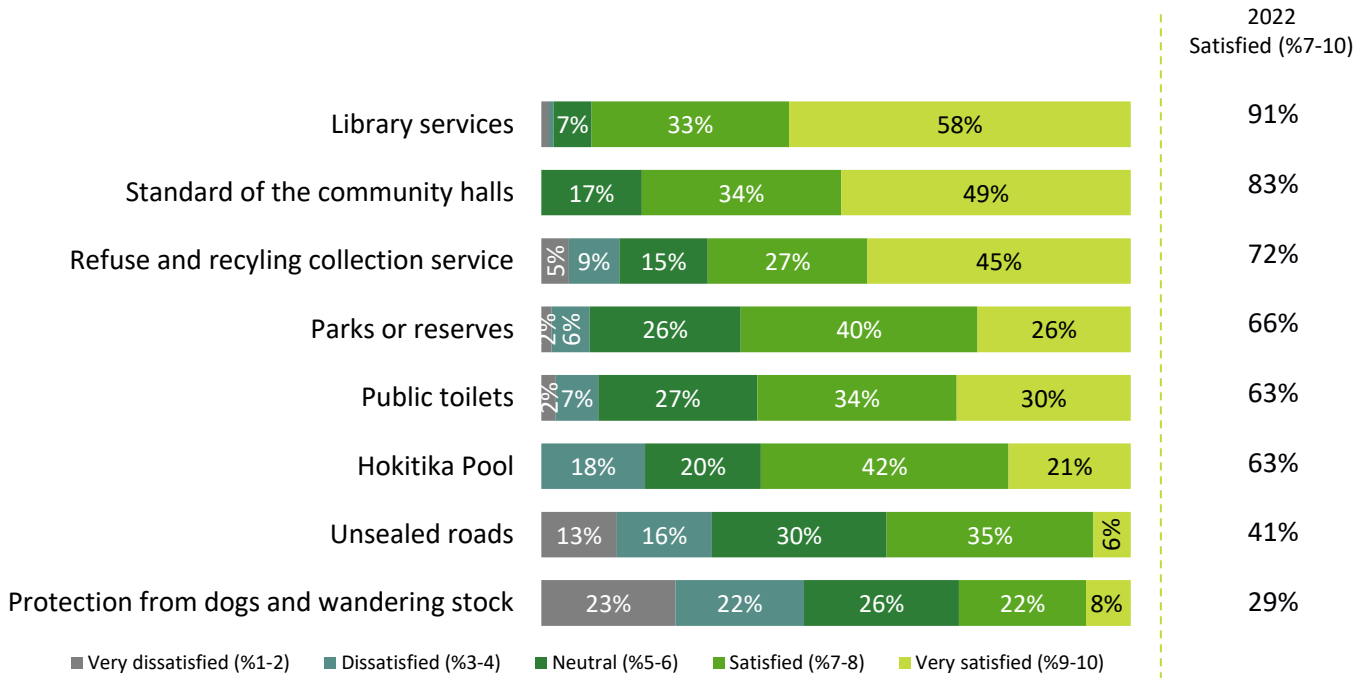

Scores with % 7-10	2022			
	2022	Northern	Hokitika	Southern
Library service	91%	92%	91%	91%
Standard of the community halls	83%	75%	99%	85%
Refuse and recycling collection service	72%	78%	69%	64%
Parks or reserves	66%	70%	66%	59%
Public toilets	63%	66%	65%	60%
Hokitika Pool	63%	71%	43%	100%
Unsealed roads	41%	37%	43%	45%
Protection from dogs and wandering stock	29%	23%	15%	46%

Significantly higher than the other ward(s)
Significantly lower than the other ward(s)

NOTES:

1. Sample: 2022 n=365; Excludes 'Don't know' or blank responses
2. Q2. Using a rating scale of 1 to 10 where 1 is 'very dissatisfied' and 10 is 'very satisfied', how satisfied are you with the protection provided from dogs and wandering stock?
3. Q5. Using the same 1 to 10 rating scale, how satisfied are you with parks and reserves in the District?
4. Q8. How satisfied are you with the public toilets in the District?
5. Q11. How satisfied are you with library services in the District?
6. Q15. Using the same 1-10 rating scale, how satisfied are you with the quality of swimming and exercise experience at the Hokitika pool?
7. Q18. How satisfied are you with the standard of the unsealed roads?
8. Q21. How satisfied are you with the standard of the community halls?
9. Q24. How satisfied are you with the refuse and recycling service you receive?



Contact with Council and Customer Services Centre

Environment health services

5%

Have contacted Council regarding environment health



Satisfaction with the quality of the advice received

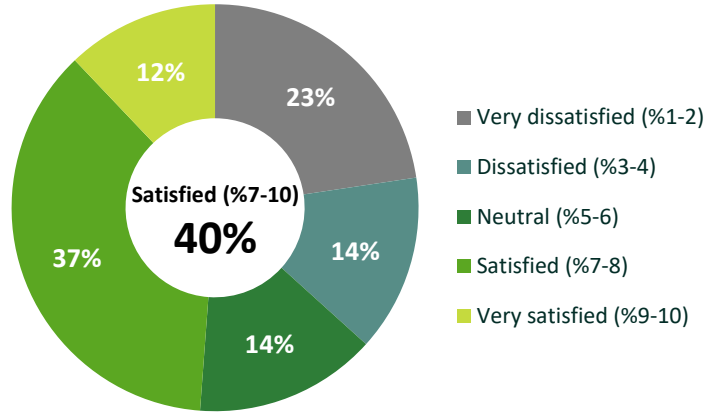

Reasons for score given

They wanted nothing to do with the issue which was toxic substances being pumped out to sea. I know it's toxic as I used to deal with it.

The council has changed the water courses which has led to flooding. This has caused contamination from a trucking company across the road into the neighbouring land on the other side of the road. I have no faith in our council.

They never came back to me in regard to spraying waterways with roundup. I spoke to one of the Councillors and that was the end of the matter.

They were good with the situation, they dealt with it alright.

When I rang them, they said they had to come from Greymouth which is totally ridiculous when you have got music blaring in the middle of the night. I don't know if they even bother coming.

It was about a water leak, and I never received a reply, but it could have been when we were isolating for Covid.

In the last year, only a few residents (5%) have contacted Council regarding *Environment health*. Two in five of this proportion are satisfied with the *quality of the advice they received* from Council.

Liquor licensing

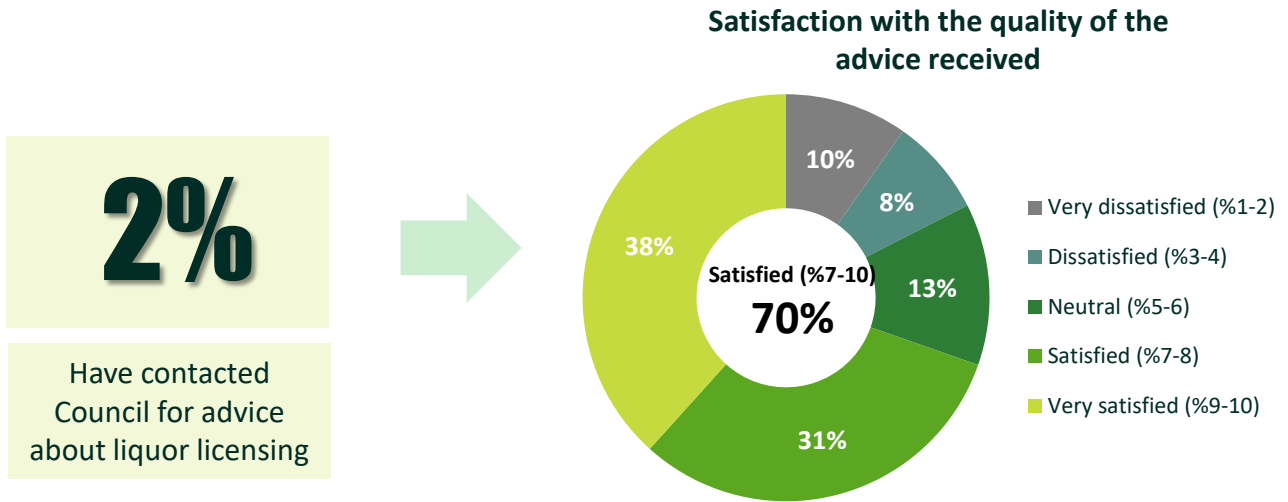

Reasons for score given

I was refused to renew my license because I wasn't a practicing bar person.

I never heard back. I put a submission in and never heard anything.

It was fantastic, the guys were on to it. This was for liquor licensing.

The person I spoke to didn't have the knowledge that I required. I didn't get satisfactory information.

I thought it was a bit vague and airy fairy.

Good service.

It takes too long for a license to be renewed or granted.

Seven in ten residents (70%) who have contacted Council for advice about *Liquor licensing* issues are satisfied with the *quality of the advice provided* by Council.

NOTES:

1. Sample: 2022 n=365; Excludes 'Don't know' responses
2. Q29. In the last year, have you contacted Council for advice about liquor licensing issues? Yes n=10 (Caution: small sample size)
3. Q30. How satisfied are you with the quality of the advice provided for liquor licensing matters?
4. Q31. Could you please tell us why you feel that way?

Building consent

19%

Have contacted Council regarding building consent matters

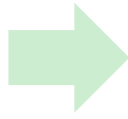

Satisfaction with the quality of the advice received

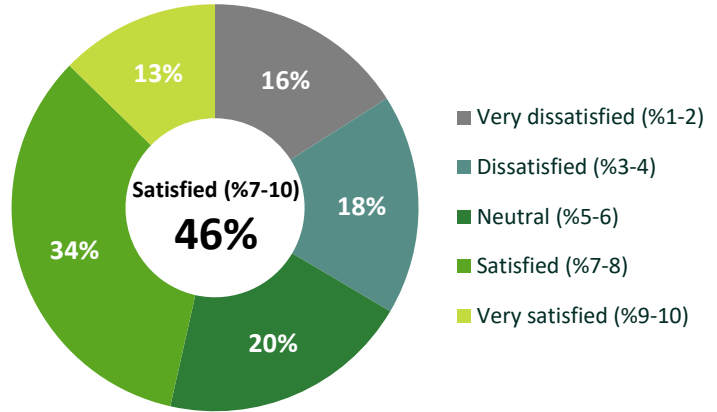

Reasons for score given

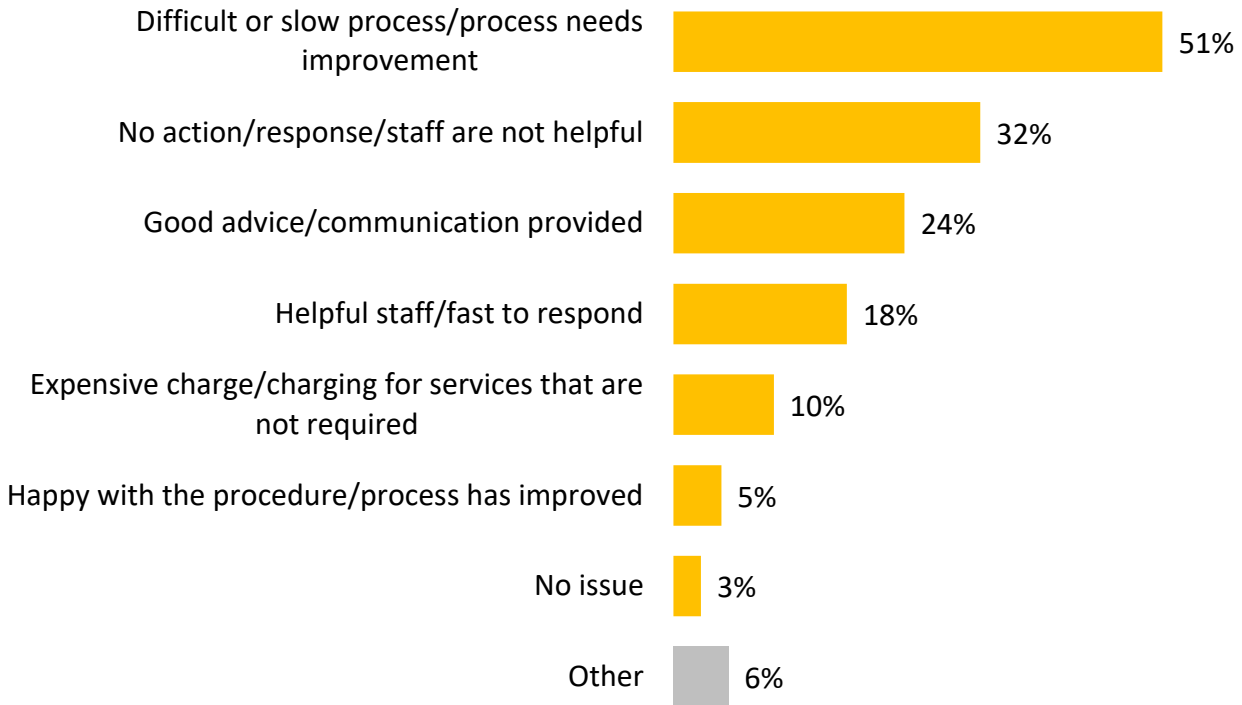

Just under two in ten residents (19%) have contacted Council regarding *Building consent* matters and 46% of them are satisfied with the *quality of the advice they received*. Some residents perceive the *process to be difficult/slow and needs improvement* (51%) and the *staff to be unhelpful* (32%) while the others have received *good advice/communication* (24%) and experienced *timely response from staff* (18%).

NOTES:

1. Sample: 2022 n=365; Excludes 'Don't know' responses
2. Q32. In the last year, have you contacted Council regarding building consent matters? Yes n=41
3. Q33. How satisfied are you with the quality of the advice you received regarding building consent matters?
4. Q34. Could you please tell us why you feel that way? n=37

Customer Services Centre

Satisfaction with the service received

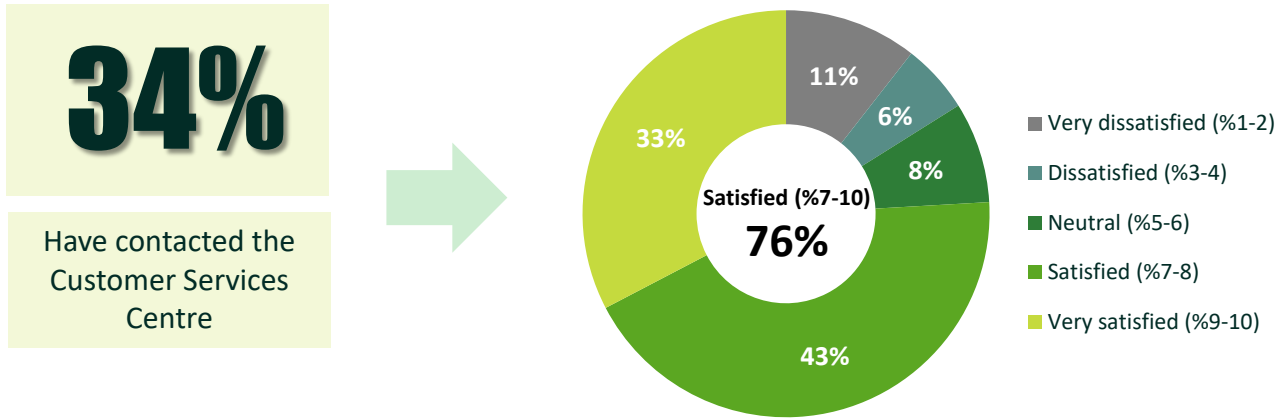

Just over one third of residents (34%) have contacted Westland District Council's *Customer Services Centre* and most of these residents are satisfied with the *service they received*.

NOTES:

1. Sample: 2022 n=365; Excludes 'Don't know' responses
2. Q35. Have you contacted the Customer Services Centre, either in person, by phone and/or by email? Yes n=139
3. Q36. How satisfied are you with the service you received?

Contact with Council and Customer Services Centre

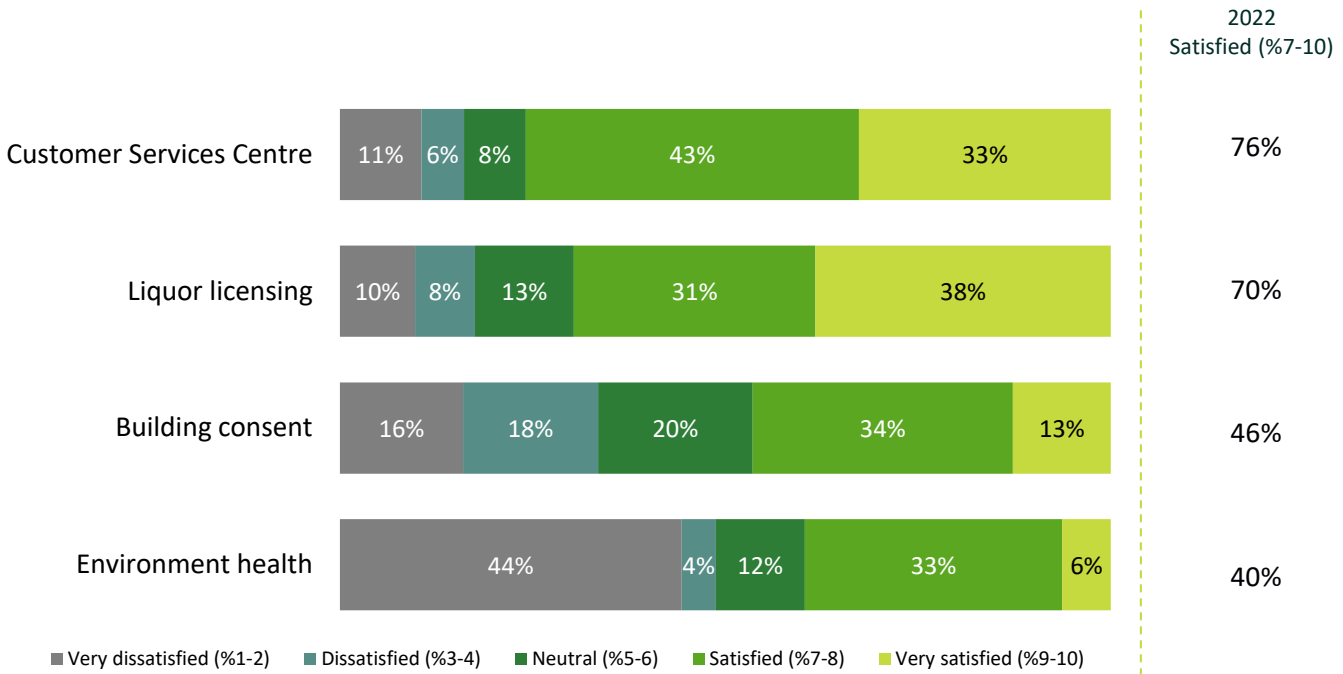

Scores with % 7-10	2022	Northern	Hokitika	Southern
Customer Services Centre	76%	78%	74%	75%
Liquor licensing	70%	-	66%	100%
Building consent	46%	60%	39%	-
Environment health	40%	60%	40%	27%

There is no significant difference by ward in terms of the satisfaction with the *service received from the Customer Services Centre*.

- NOTES:
1. Sample: 2022 n=365; Excludes 'Don't know' or blank responses
 2. Q27. How satisfied are you with the quality of the advice you received?
 3. Q30. How satisfied are you with the quality of the advice provided on liquor licensing matters?
 4. Q33. How satisfied are you with the quality of the advice provided on building consent matters?
 5. Q35. Have you contacted the Customer Services Centre, either in person, by phone and/or by email?



Council consultation and community involvement

Council consultation and community involvement

Understand how Council makes decisions

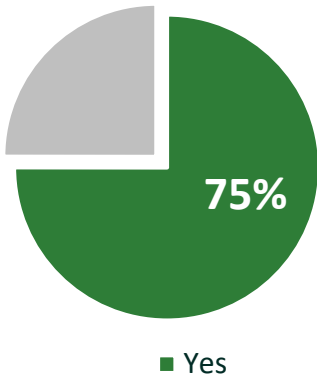

Satisfaction with how Council involves the public in the decisions it makes

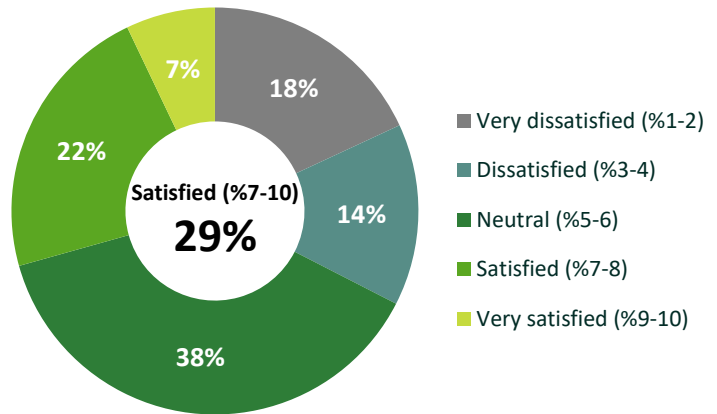

Comments about how Council makes decisions and engages with community

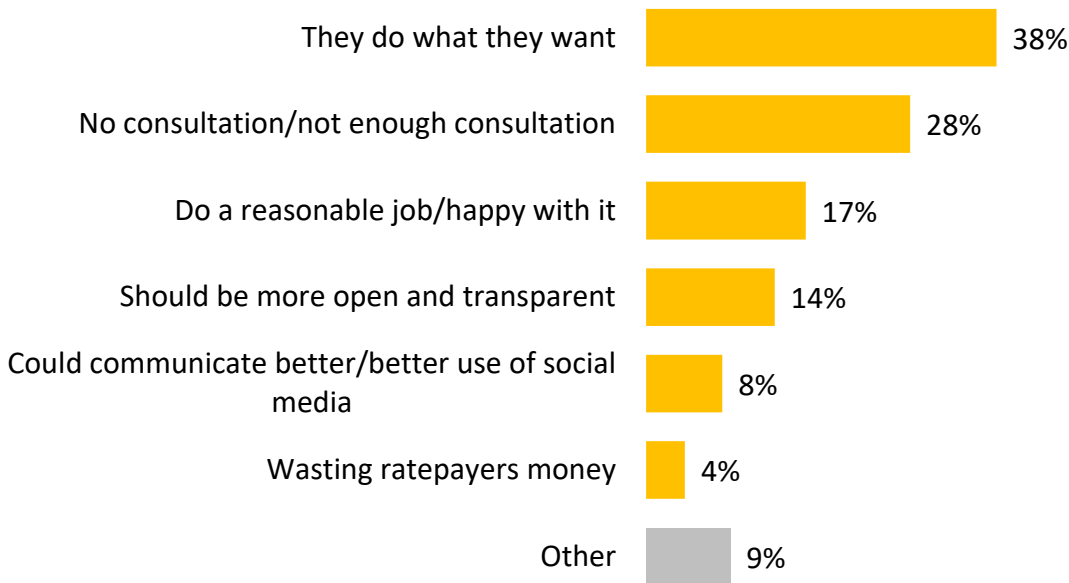

Three in four residents (75%) understand how Council makes decisions. Fewer than three in ten (29%) are satisfied with how Council involves the public in the decisions it makes. Some of the comments pertain to Council doing what they want (38%), and lack of or inadequate consultation (28%) while 17% of residents who gave a comment are happy and think Council is doing a reasonable job in engaging with the community in consultation.

NOTES:

1. Sample: 2022 n=365; Excludes 'Don't know' responses
2. Q39. In general, do you understand how Council makes decisions? Yes n=272
3. Q40. Using a scale of 1 to 10 where 1 is 'very dissatisfied' and 10 is 'very satisfied', how satisfied are you with the way your Council involves the public in the decisions it makes?
4. Q41. Do you have any comment about how Council makes decisions and engages with the community in consultation? n=261; Items ≤1% are not shown.



Drivers of perceptions

Drivers of perceptions of Westland District Council's performance

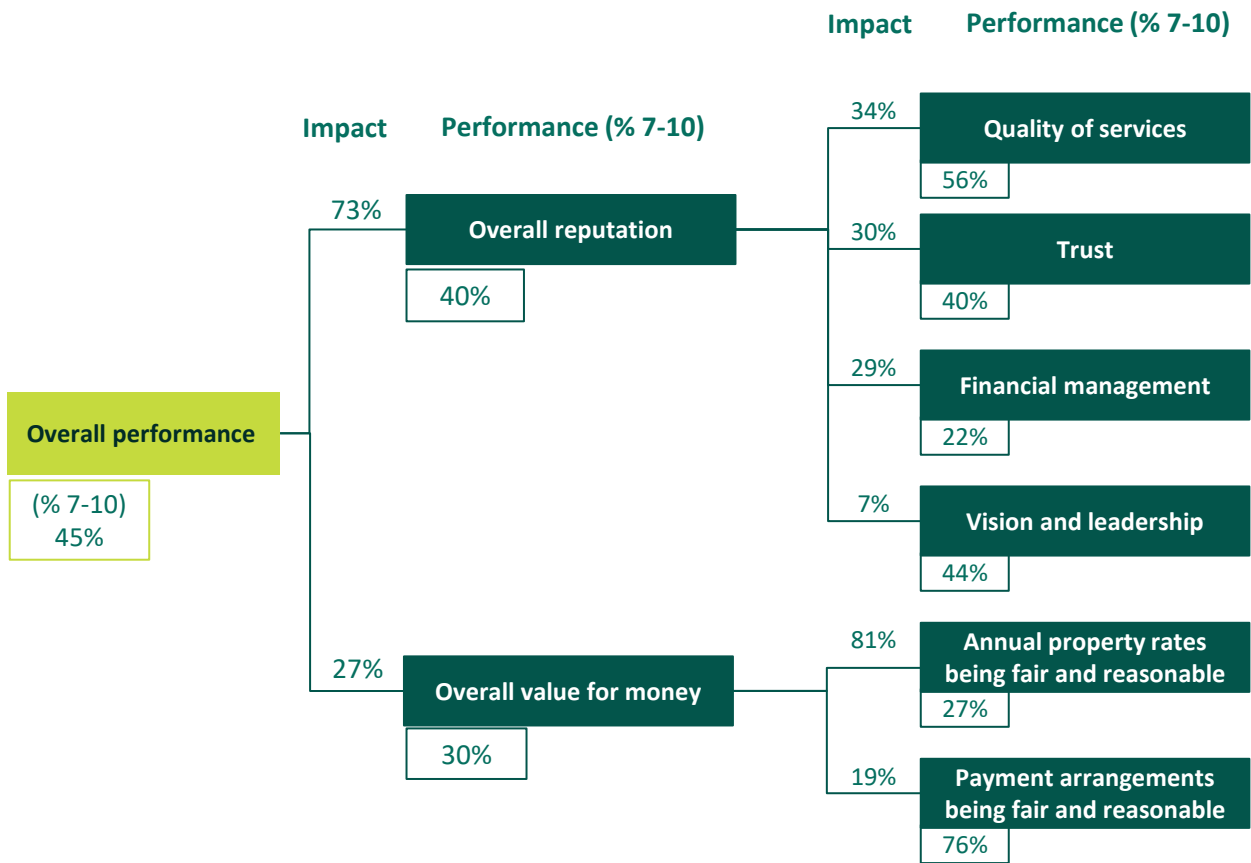

Overall reputation is the main driver of perceptions of *Westland District Council's Overall performance* while *Value for money* has lesser influence.

Satisfaction with the *Quality of services* has the greatest impact on the perceptions of Council's *Overall reputation*, followed by *Trust* and *Financial management*. *Vision and leadership* has the least influence. Improving performance regarding *Trust* and *Financial management*, given their relatively low satisfaction scores, will likely improve perceptions of Council's *Overall reputation*.

Annual property rates being fair and reasonable drives satisfaction with *Overall value for money* and since satisfaction with this attribute is low, Council should consider this area as an improvement priority.

NOTES:

- Sample: 2022 n=365; Excludes 'Don't know' responses
- Q51. Thinking about Council overall their image and reputation, the services and facilities they provide and the rates and fees that you pay, overall, how satisfied are you with the Westland District Council?
- Q50. Everything considered – leadership, trust, financial management, and quality of services provided, how would you rate Westland District Council for its overall reputation?
- Q45. Thinking about the services and facilities you have experienced in the past twelve months and what you have experienced in the past twelve months, how satisfied are you with how rates are spent on services and facilities provided by Council and the value for money you get for your rates?

Opportunities and priorities: Overall measures

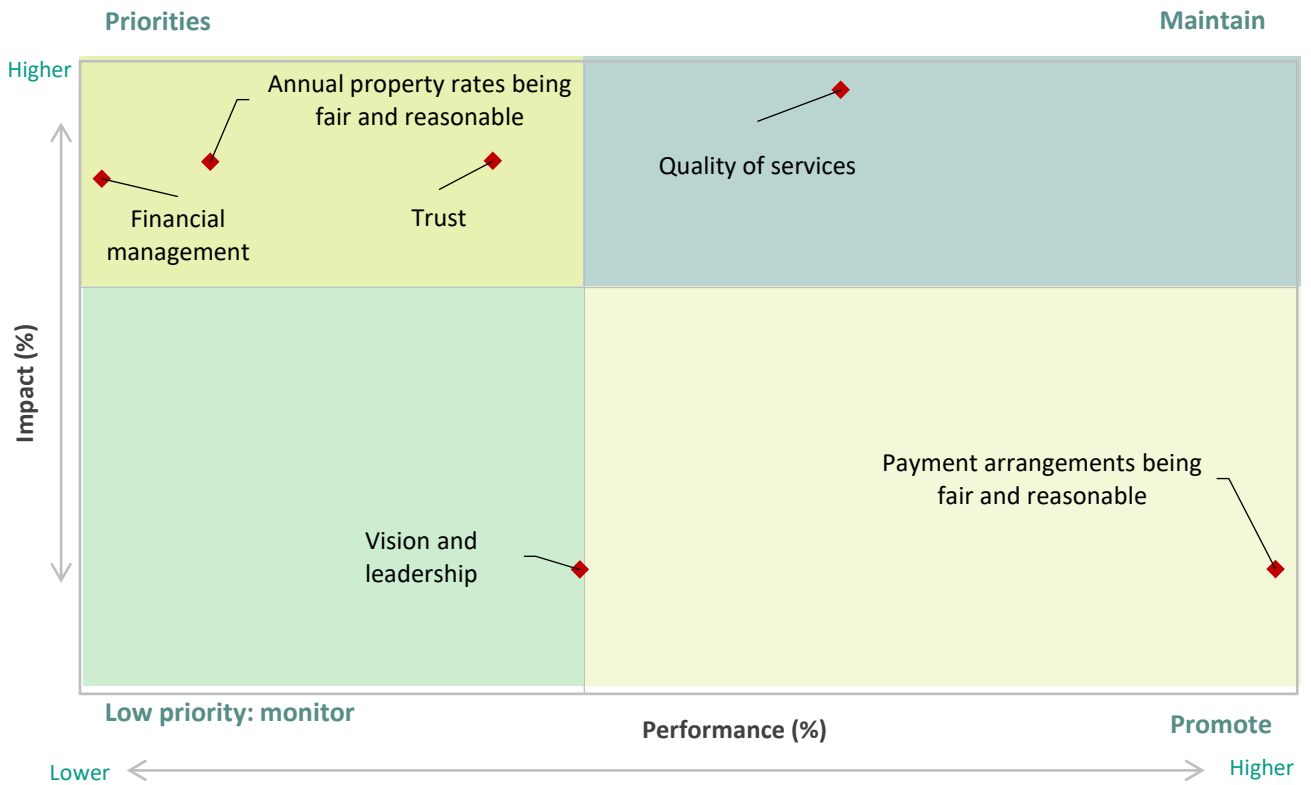

The key improvement opportunities for Westland District Council is to improve residents' satisfaction with *Financial management, Annual property rates being fair and reasonable, and Trust*

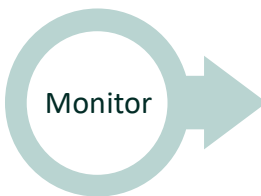

The area where Council should monitor its performance points to *Vision and leadership*



Westland District Council should maintain its performance in relation to the *Quality of its services*



The most underappreciated area of Council's performance is regarding *Payment arrangements being fair and reasonable*



Public safety

Public safety

Perceptions of Westland District as a safe place to live

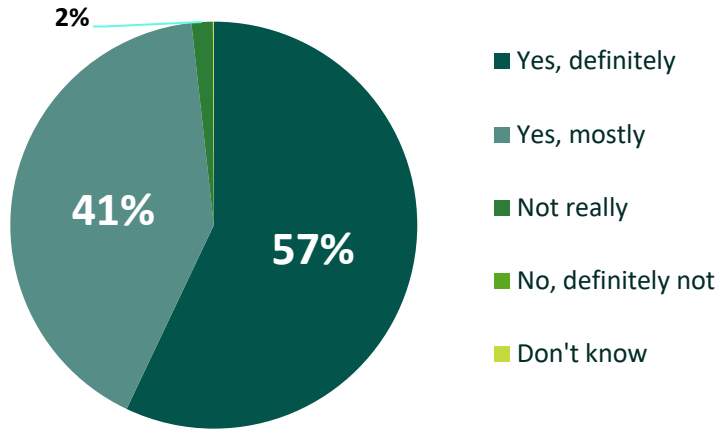

Reasons for perception of Westland District as a generally safe place to be

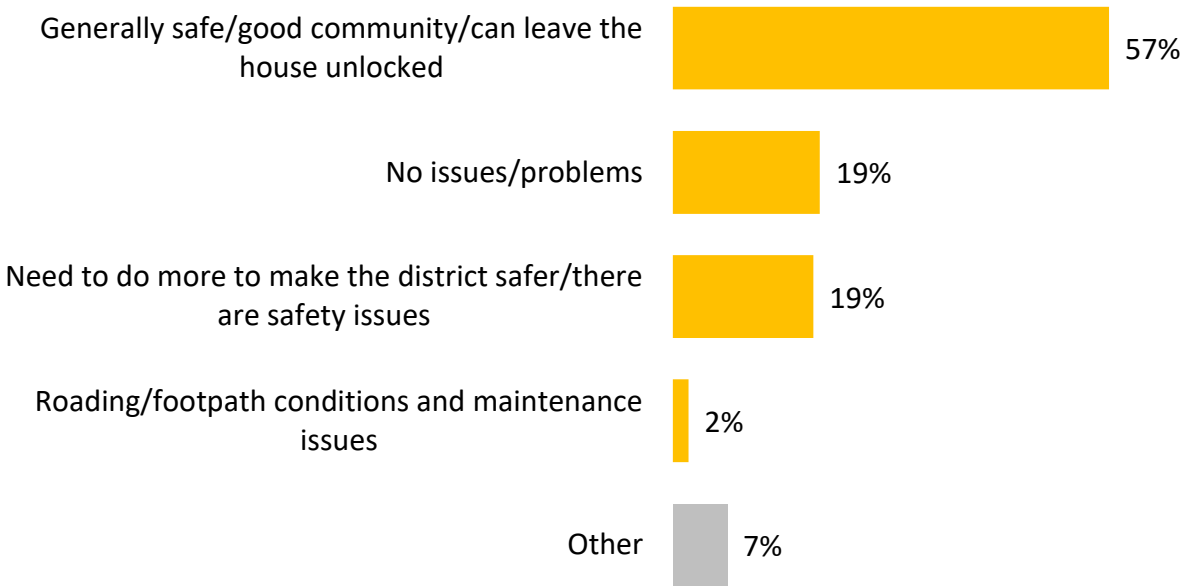

Nearly all residents (98%) perceive *Westland District as a safe place to be* citing the area as *generally safe and with a good community* (53%). Some residents have *no issues or problems* about safety (19%) while the others mentioned the *need to make the district safer* (19%).

NOTES:

1. Sample: 2022 n=; Excludes 'Don't know' responses
2. Q42. Do you feel that Westland District is generally a safe place to live?
3. Q43. Could you please tell us why you feel this way? n=338



General comments

General comments

Other comments about Westland District Council

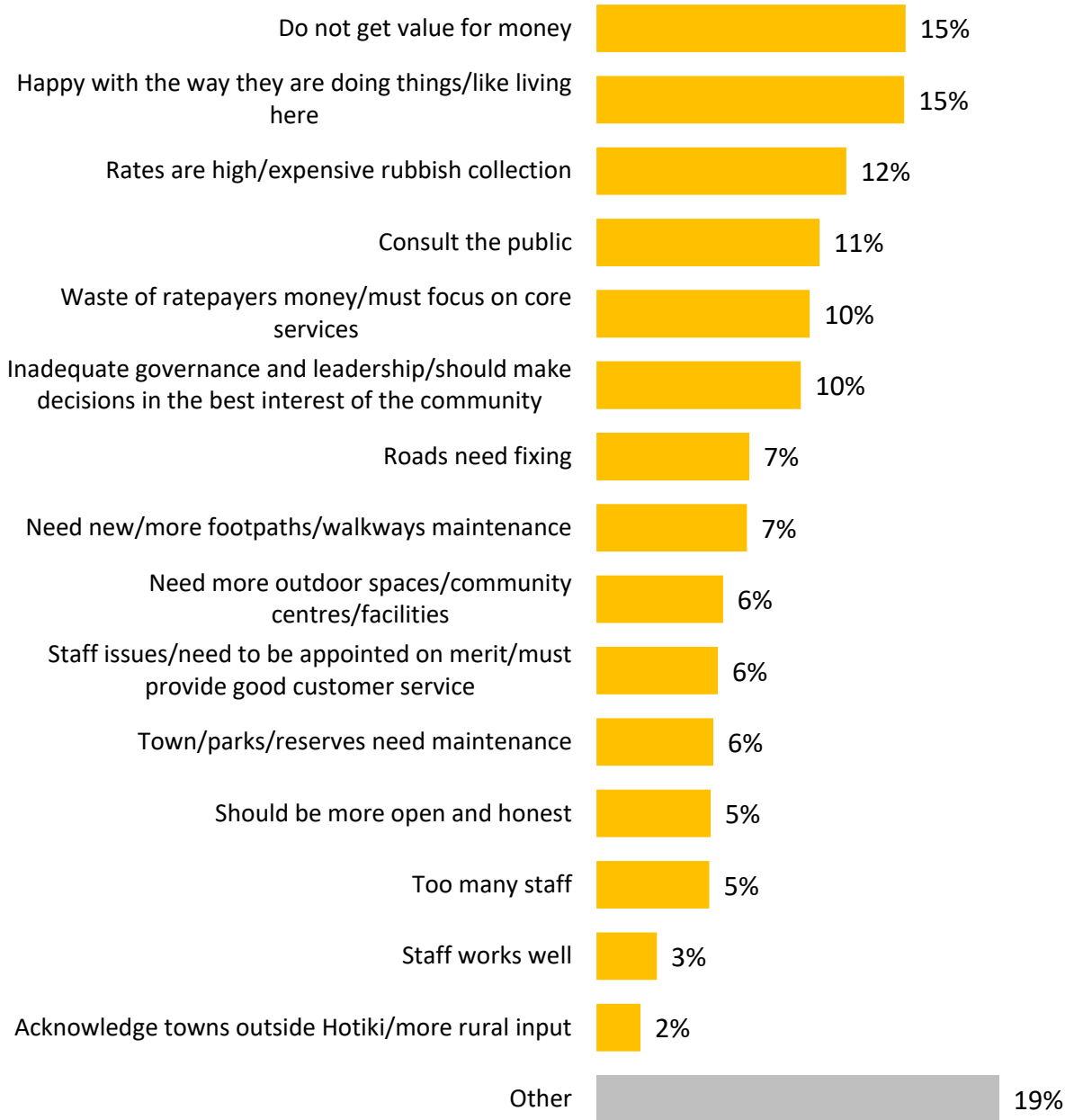

The residents have indicated a range of issues, concerns and suggestions when asked to make a comment about Westland District Council in general.

NOTES:

1. Sample: 2022 n=365; Excludes 'Don't know' or blank responses
2. Q52. Are there any other issues, concerns or suggestions you would like to raise about Westland District Council? n=207; Items ≤1% are not shown



Sample profile

Sample profile

Gender



Age (weighted)

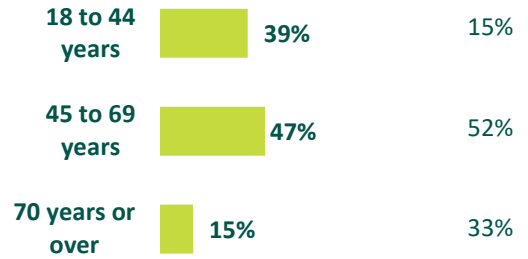

Ethnicity (weighted)

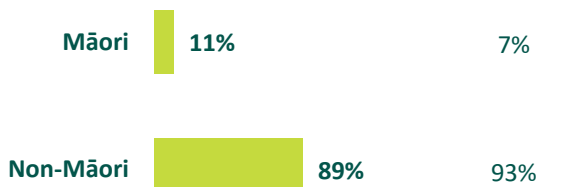

*Multiple response

Paying rates (weighted)

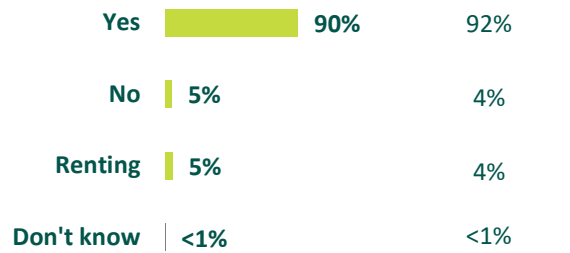

Sample profile

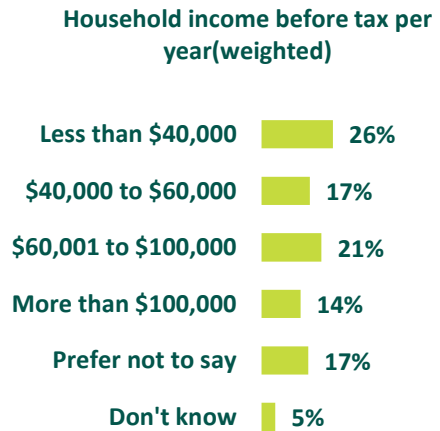
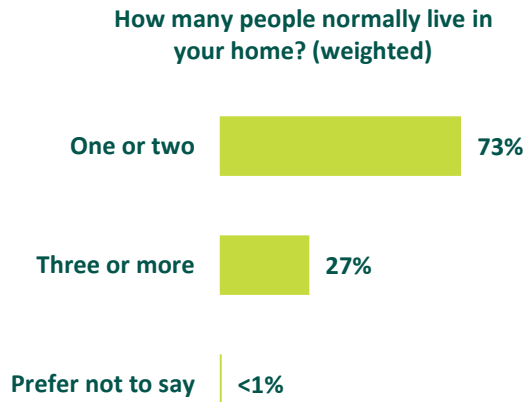
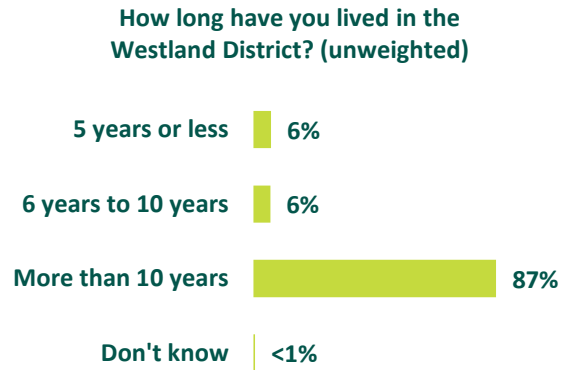
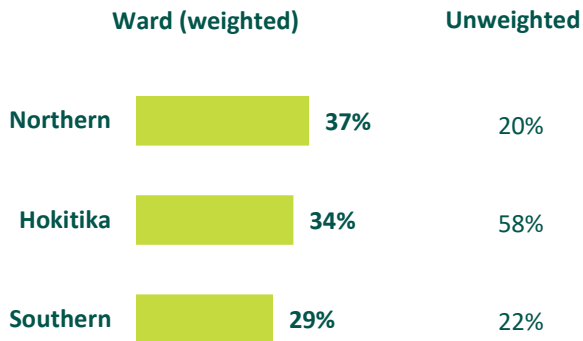



Appendix A – Results by key demographics

Services

Scores with % 7-10	2022	18 to 44 years	45 to 69 years	70 years or over
Protection from dogs and wandering stock	29%	-	40%	32%
Parks or reserves	66%	57%	74%	71%
Public toilets	63%	60%	62%	80%
Library services	91%	94%	86%	99%
Hokitika Pool	63%	60%	67%	59%
Standard and safety of unsealed roads	41%	50%	36%	35%
Standard of community halls	83%	75%	87%	91%
Refuse and recycling service	72%	67%	71%	86%

Scores with % 7-10	Māori	Non-Māori	Northern	Hokitika	Southern
Protection from dogs and wandering stock	100%	28%	23%	15%	46%
Parks or reserves	55%	68%	70%	66%	59%
Public toilets	67%	63%	66%	65%	60%
Library services	90%	92%	92%	91%	91%
Hokitika Pool	46%	68%	71%	43%	100%
Standard and safety of unsealed roads	22%	44%	37%	43%	45%
Standard of community halls	66%	84%	75%	99%	85%
Refuse and recycling service	83%	70%	78%	69%	64%

Scores with % 7-10	Male	Female	Pay rates	Do not pay rates	Renting
Protection from dogs and wandering stock	-	36%	33%	-	-
Parks or reserves	71%	61%	65%	56%	100%
Public toilets	70%	57%	63%	97%	49%
Library services	88%	94%	91%	100%	100%
Hokitika Pool	61%	64%	61%	-	100%
Standard and safety of unsealed roads	42%	41%	39%	37%	78%
Standard of community halls	75%	91%	84%	59%	100%
Refuse and recycling service	74%	70%	71%	94%	67%

Contact with Council, Customer Services Centre and Council consultation

Scores with % 7-10	2022	18 to 44 years	45 to 69 years	70 years or over
Quality of advice received – Environment health	40%	24%	56%	63%
Quality of advice received – Liquor licensing	70%	100%	59%	70%
Quality of advice received – Building consent	46%	53%	40%	19%
Customer Services Centre	76%	85%	70%	76%
Council consultation and community involvement	29%	30%	27%	35%

Scores with % 7-10	Māori	Non-Māori	Northern	Hokitika	Southern
Quality of advice received – Environment health	62%	32%	60%	40%	27%
Quality of advice received – Liquor licensing	-	70%	-	66%	100%
Quality of advice received – Building consent	12%	49%	60%	39%	0%
Customer Services Centre	98%	72%	78%	74%	75%
Council consultation and community involvement	20%	30%	34%	27%	26%

Scores with % 7-10	Male	Female	Pay rates	Do not pay rates	Renting
Quality of advice received – Environment health	34%	51%	40%	-	-
Quality of advice received – Liquor licensing	73%	65%	70%	-	-
Quality of advice received – Building consent	51%	39%	51%	-	-
Customer Services Centre	78%	74%	75%	100%	100%
Council consultation and community involvement	28%	31%	30%	15%	24%

Reputation and Value for money

Scores with % 7-10	2022	18 to 44 years	45 to 69 years	70 years or over
Vision and leadership	44%	45%	42%	48%
Trust	40%	48%	34%	42%
Financial management	22%	21%	20%	28%
Quality of services	56%	61%	49%	61%
Annual property rates being fair and reasonable	27%	31%	20%	37%
Payment arrangements being fair and reasonable	76%	85%	72%	72%

Scores with % 7-10	Māori	Non-Māori	Male	Female
Vision and leadership	19%	47%	43%	44%
Trust	43%	40%	47%	34%
Financial management	14%	23%	24%	19%
Quality of services	36%	58%	58%	53%
Annual property rates being fair and reasonable	9%	29%	32%	21%
Payment arrangements being fair and reasonable	81%	76%	75%	78%

Scores with % 7-10	Pay rates	Do not pay rates	Renting
Vision and leadership	45%	17%	37%
Trust	41%	17%	50%
Financial management	21%	12%	72%
Quality of services	55%	61%	67%
Annual property rates being fair and reasonable	26%	0%	60%
Payment arrangements being fair and reasonable	77%	85%	38%

Head Office

Telephone: + 64 7 575 6900

Address: Level 1, 247 Cameron Road
PO Box 13297
Tauranga 3141

Website: www.keyresearch.co.nz

Key Staff

Project lead: **Laarni Mandap**
Research Executive

Telephone: + 64 7 929 7071

Email: laarni@keyresearch.co.nz

DISCLAIMER

The information in this report is presented in good faith and on the basis that neither Key Research, nor its employees are liable (whether by reason of error, omission, negligence, lack of care or otherwise) to any person for any damage or loss that has occurred or may occur in relation to that person taking or not taking (as the case may be) action in respect of the information or advice given.

Westland District Council
Residents' Satisfaction Survey 2022
Verbatim Report

Index

[Protection from dogs and wandering stock](#)

[Parks or reserves](#)

[Public toilets](#)

[Library services](#)

[Non-use of library services](#)

[Hokitika pool](#)

[Unsealed roads](#)

[Community halls](#)

[Refuse and recycling](#)

[Environment health](#)

[Liquor licensing](#)

[Building consent](#)

[Performance of the Mayor and Councillors](#)

[Council consultation and community involvement](#)

[Public safety](#)

[General comments](#)

ID	RC	Q3. Could you please tell me why you feel this way? - Protection against dogs and wandering stock
	NQJ27533B4	I contacted dog control about a wandering dog, they told me they wouldn't come unless I caught the dog myself.
15	54M86G63X3	What is the point of dog control then? Intervened to assist a person having a problem with a dog in the neighbourhood that occurred because of inadequate fencing. The dog ranger (male, over 60 at a guess) was excellent - and the family involved resolved the fencing. Great outcome.
40	62 A666XC43DA	I feel that it is hard to get a hold of.
63	23A22P6JC4	Still too many wandering dogs in and around town.
68	R3X24YR7Q2	Dog still chases cars, comes out and is aggressive towards other people walking dogs, When dog owner is home, gate is left open, dog still wandering.
89	RPXQ77BDP7	The response is not very prompt or enthusiastic to say the least.
95	U3D5DBC48M	People leave their dogs at home barking at any roaming dogs dumping or mower lawns/movement, dogs out making a nuisance, etc.
97	HG6F35S4X5	Lack of online services in regards to dog registration, updating of information and afterhours service.
133	588EMC6GSB	Most of the time they are pretty good. Dog control are a big harsh on picking up dogs out the front of your house. I've been told to get my dog from the beach and the dog was with me. They don't always get their facts right.
135	52A4K3X883	There was a stray dog and they wouldn't help out with it or even take it. We are on a farm.
141	57HB4847V2	I don't have any faith in them at all. People walk around without dogs on leashes and nothing. Our neighbours cat got killed by a roaming dog.
158	DE6N88483X	It took a long time for the chap to turn up. I know he lives close, but maybe he was busy.
200	PKL6V82LAQ	I was told face to face there was nothing they could do about the dog control for making a complaint about wandering dogs. If I complained again they said they would prosecute me. Several neighbours complained, two others were told they would be prosecuted. Where we live there are clear covenants so dogs aren't a nuisance. We tried to help the neighbours with their dogs. When the dog attacked a small dog, one of the dogs was put down, the other two are still roaming.
203	43GWDN347K	My mother has problems with barking dogs. I've heard lots of problems. What is the point of a dog control officer? We phoned about a dog, they found the owner.
236	FLQ7SE3Q7W	Efficient service, and it was on the weekend too. Lots of stock on the road. A very dangerous road to have wandering stock at night. Someone sorted it out. We even got a follow up phone call.
260	8W243TKGVU	They answered the phone and came out.
277	Y73Q3CU7W6	I left two messages with the stock controller and he never got back to me. The third time I rang, I left a message that I was going to the media. He called back in half hour. I had a cup of coffee with him the next day and heard all is issues. He should have served a notice on the owner to say that he needs to keep his stock in the paddock.
290	8UXTAV88UK	I called after hours and my call got diverted to Greymouth and the person couldn't come for hours.
296	L28C2QV6P4	They didn't do anything in regards to the complaint about a dog. I think they should have.
297	KCU5S46U5E	Nothing is done. The last dog ranger was hopeless. Our small dog was attacked by another dog. We never even got a apology. It cost us over \$1,000 at the vets.
301	688P4R4224	The response was immediate and very informative and helpful.
347	36XK3J4467	It took a while to get to the right person to sort out the problem.
354	L2J538668W	We have lost over five and half thousand dollars worth of plants in the past 10 years because of wandering stock. It's terrible - cows that have stripped our native trees.

ID	RC	Q6. Could you please tell me why you feel this way? - Parks or reserves	 Index
1	2XRMG654MU	Very much against the slash and burn policy applied to the trees and shrubs around Cass Square. All of the shelter from the wind was taken out - for the elderly this posed very real problems and made Cass Square walks very uncomfortable. A very short sighted decision by one or two people.	
3	3H82BQQKQ4	The grounds and gardens are untidy and unkept.	
4	U2224FFPK8	Maintenance not to the high standards of approx. five years ago. Jobs started and not finished with all cones/signs all laying around. Get jobs completed asap when started before starting any new job - e.g. Cass Square memorial, poles for new Christmas tree lights.	
6	8RPPR24Y7T	There was a lot of dumped rubbish including nappies in the bush.	
7	P666QY85R2	Some weeds are getting away.	
8	GVX74254L7	Most are DOC operated not Westland District council.	
9	7LR78WY7B5	It's alright. Pretty basic.	
11	MTCU476NKE	They are not always up to standard and parts available for my grandchildren to use safely.	
13	H4RR2WK3J4	Average as now that no one is visiting the area. Nothing is being maintained and looked after.	
14	54GBDSTCK2	Generally they were reasonably tidy.	
15	NQJ27533B4	Parks are generally well maintained. The playgrounds are a bit run down though.	
18	HF23E8B8GJ	Reasonably maintained.	
20	P73DLWYA36	Tidy clean and well serviced.	
21	VNUSJ4AV65	Mostly clean and tidy.	
22	6W5B6W3TVB	It was alright.	
23	6PW48NAX62	Appearance is important and sometimes not so good.	
24	QRHC76CTH3	Shrubs and other flowering plants were removed from local park,[the only local park that there is here] and not replaced with anything. Children's playground needs a revamp, sadly neglected, council did report in the local paper 2-3 years ago it would be upgraded, still nothing done, and please don't blame covid!	
25	834ELHK644	No.	

26	6YAR5TG72H	Rubbish removal is not done often enough during peak season (e.g. weekends).	
27	PTBF52JTX5	Well looked after. Clean and tidy.	
30	3KE5FH3P76	Some of the parks could use some attention.	
32	6D48LD2S7S	Lazer Park, great for kids. Will improve with access to toilets.	
34	2383T8RB3Q	Less money (per capita) appears to be spent on parks and reserves maintenance/upkeep or development in WDC rural townships than in Hokitika.	
35	LBBVEH73DC	There is so much potential for the reserves to be made more accessible for the public and for tracks to be upgraded to provide better public access for walking and biking. Hokitika has a real future if we link up the tracks out to the Blue Spur mountain bike trails and have better sign posting so people can find the trails. The tracks out the back of the racecourse are in very poor condition. I think in general the reserves that are well managed are for specific sports or purposes and we need to diversify. That will grow this town and grow its economy. Further south, the Okuru Recreational reserve appears to be completely fenced off and grazed with deer. It's over run with hundreds of rabbits which are starting to cause big problems. This reserve is in no way being used for the provision of an area for recreation and sporting activities. The public have no way of accessing this reserve.	
36	65C628644P	There is no attention to detail in maintenance, i.e., mowing of road edges and gardens and lawn edges.	
37	X6332J56L5	Grass is not maintained at a consistent length over the growth period.	
38	64VAT555WP	Playground in Hokitika needs attention. There is no suitable playground or park for under 5's, need a fenced in one. The parks and reserve facilities here are limited and not well maintained, especially compared to other towns such as Ashburton, Oamaru and Gore, which all have great gardens, playgrounds, shaded parks and reserves.	
39	35C2553333	They are all great.	
40	54M86G63X3	I walk on Cass square regularly and it is always brilliantly maintained. Any staff there at the time are always very friendly and pleasant.	

41	5384P8T83W	They were run down and not maintained.	
42	5DUN8473FX	Nice area. Well maintained. Good parking.	
43	BW23G6Y52S	Should be more dog-friendly places.	
45	R7658647RH	They are kept tidy and accessible.	
48	8VN8L8D53M	Can't complain too much, but it would be good to have a new park for the kids at Cass Square. The existing one is tired, and new picnic tables don't really cut the mustard.	
50	75UK66R6MG	Generally I find most of the public parks and reserves are very well maintained by the Council, even some of the areas in South Westland which I am not sure if they are maintained by Council staff or well meaning people in the community but look tidy for visitors and locals.	
52	YU2F24Q23F	They seem to be well maintained and accessible.	
53	P3SWVQTWUU	Love all the beautiful bush we get to enjoy, and it's so well kept. The paths and facilities are very well looked after. It would be nice to have more options for bringing our dogs with us, but I understand you have to make rules for the lowest common denominator. I'd like an off-leash dog exercise area (like The Groynes in Christchurch), and it would be perfect here!	
54	CTCL5YBCBT	They are adequate and provide greenery.	
55	USRMSM38VW	The parks and reserves are often clean and tidy, have good facilities and are not overcrowded.	
57	VB8445N866	I feel reserves are great. We could do a lot more to be children inclusive.	
58	6FDJXE4GDP	Always well looked after with great facilities.	
59	E87LH5NUE2	Some better than others, can take a long time to mow some.	
60	QTY2JPPT76	Always tidy and great views.	
61	Q336266YNQ	Tracks not maintained. Very weedy and over grown trees out onto the tracks.	
62	A666XC43DA	They could be cleaner and more tidy. Playgrounds are absolutely appalling compared to the rest of New Zealand.	
63	23A22P6JC4	Far to many often poorly maintained , un-mown un-kept areas around town. Kaniere reserve and park opposite Dents Road are some examples.	

64	S2Y7GY6GC2	Cass Square. a lot of \$\$ has been spent on the surface yet it was let to dry out during our warm spell, all the nice attractive trees have been pulled out so as to lower maintenance cost \$\$ are waisted in other areas without question.	
65	7AECJ6CLPB	I am an older person who still tries to exercise regularly. The park is ideal and safe.	
66	PMA6Q5Q7XW	The parks are really good, lots of play equipment and awesome for the kids but there's nowhere to sit! Cass square needs more picnic benches and seating to be able to watch kids on the playground, Lazar park is amazing, awesome what the lions have done but again zero seating!	
67	WS6CSX32Q4	Could have better toilet facilities, otherwise, got to love our West Coast scenery.	
71	UFK8ACBNBG	Well set out and tidy.	
82	R52SAB6L4H	Neat, tidy area, satisfied!	
85	T22BQ7D3N8	Nice park.	
86	4275JK5777	The facility was good but the lawns needed mowing more often.	
88	876F2CB5K7	They are well looked after.	
90	AHL3R2QFJ6	Toilet facilities have improved. Hoki Gorge in particular.	
91	F58EP6T55W	Clean, tidy.	
94	X4AEJK448L	Need updating!	
95	U3D5DBC48M	Council workers to keep parks tidy. Once again dog on leads roaming where children play.	
96	435XJ8MA3Q	Walk around Cass Square daily. Easy concrete, fine and not broken.	
97	HG6F35S4X5	Disinterest in public safety by operations manager.	
99	ETL3AD4E5J	Parks have no toilet facilities and are not closed in for younger children.	
103	JH3MK5S3P2	They are kept to a reasonable condition.	
104	66867BWNWM	Needs more regular mowing & maintenance.	
105	45E734TNM3	Just stunning and well maintained.	
106	A8B83P8VS8	Overall they provide, quite good for our district.	
107	MVHGWMD7CM	Not enough sensory play areas suitable for all members of the community, e.g. Special needs, elderly.	

124	LQ7G3766CV	The lack of maintenance.	
125	U7BU3K4CB5	Some of the parks here, the locals spend time with the up keep and I go past some occasionally and think that could do with a tidy up. Lack of funding at present time makes it difficult to keep them updated all the time.	
126	6274MWB7N2	The gardens are beautiful and the lawns are mowed.	
127	7RLRWB7TC4	Looks well maintained. Grass sometimes not too good.	
128	7BTPY766AV	I think they are great. A good variety of places.	
130	3QJ5765K85	Generally well looked after.	
133	588EMC6GSB	It's all pretty tidy and clean.	
134	SK7L58GX5M	They parks are not up to standard and not up to date.	
135	52A4K3X883	They are pretty good.	
137	456C72N8TN	Well looked after, neat and tidy and a pleasure to be there.	
138	RAYC44BCYK	Sometimes I walk and notice the kerbs are not done as regularly as they used to be.	
139	2EH4T6A26C	They are tidy.	
141	57HB4847V2	Some of the play ground is getting a bit old.	
142	GV456A27S2	The upkeep is bit behind.	
143	6C4857423N	I took my grandkids to the playground and found it neat and clean and the kids had lots to do.	
144	8W7D635E82	There are so few and they do a decent job of keeping it looking good.	
145	X62662QKQK	I like the view of Mt. Cook and the water which reminds me of Tauranga where I grew up.	
147	T84558QRTP	The parks and reserves need more maintenance.	
148	6R6KE5AGH7	They are well looked after, no issues.	
149	BJ4326F584	The contractors are not on the ball and have missed things. It's not consistent.	
150	UGL6JFM7Y7	I think it's an area that is good for the town, as long as it's kept free of rubbish it's okay.	
154	5J7V6568U3	There is nothing special about them, they lack finesse and TLC. They provide areas, but they are average.	
156	B2H2YR82YW	They are pretty good, clean and tidy.	
158	DE6N88483X	They are reasonable.	

161	P8H6A5Q4LM	They fairly well kept.	
162	X2ERX738UV	If the gorge is included it gets high marks. Low marks go to the general untidiness and unkempt lawns.	
164	8X3E5NT22Y	They are kept nicely, well mowed.	
165	4XH8LS6SPB	There is talk of changing things in the square which is needed.	
166	3347N64L6D	They are not very well kept.	
167	6SX7EY86P7	There is room for improvement for considerate consultation in relation to the parks and reserves.	
168	Y866Q3LE68	The square is well presented. The old seats were a bit hard.	
169	2V6XP654K7	They are always clean and tidy.	
171	J4KY6P3YKD	I think some of the places need upgrading. They have become a bit run down.	
172	CDJA4B5583	They are well maintained and tidy. Night lighting could improve it as kids are happy to put on a jacket and have a swing even in the evenings when it is dark.	
175	K534CT2H2B	I think what we have got is adequate for our area.	
176	P286JRDW4W	There is a disparity between good and bad parks. They all pass.	
177	4SQBVG847R	The are pretty good but some things could be done for improvement.	
179	WKM64FDYKK	The Square has had a lot of money spend and does not seem to be any better.	
180	HLQ3E5E83V	They are all clean and tidy, the ones that I have been to.	
182	53FS6EY87H	There are a few things in the play area at Cass square that need repair.	
183	2QQ6HFW3FB	Some of the amenities could be a bit more user friendly, such as the showers at Lake Mahinapau. (not sure on spelling).	
184	NS33G7VHR6	The park needs more shade for the kids.	
186	2P54MQGM4U	Based on park in Cass Square it is not safe for all ages. Not fully fenced and some of the equipment is not kid friendly.	
187	CJ35UW35XL	I think they are clean and looked after and maintained. Things could be more creative as it's a tourist town. Hokitika means coming home, we have a lot of beauty around, maybe the park could represent a bit more of that. More sculptures and plants associated with the area.	
188	L2D2PH22VE	Mainly because the Franz Joseph valley is closed.	

190	S8JCE8N2L4	There is always more they could do. Lawns or gardens that need to be tidied up.	
191	27N784YF72	As a mother I think the skate part is not fit for use. The playground at Cass square has no toilets. The playground needs upgrading. It needs more thought like the swings face the sun.	
192	UJAREF753S	They are good.	
196	46C754P4NL	Not really - I don't go there enough times. (to comment).	
197	PAU87M336U	There is a lot of park land around here and they can't attend to it all but the work on Sunset Point has been very worth while.	
198	5N242MY7M3	I am involved with the reserve in Kumara here and I find the council excellent to deal with. I have no gripes with the council as far as parks and reserves go.	
199	858455DF8Q	There are none in Franz Josef, otherwise I would rate it better.	
200	PKL6V82LAQ	Rubbish everywhere in the parks and reserves and no one picks it up. A while ago rest places were blocked off and they are still shut, it's not a good look.	
202	TU68W437D4	They are not outstanding, just good and fair.	
203	43GWDN347K	The playground is good at Cass Square.	
204	L2N2APH5X4	They just have very good access and most of them have toilets and amenities.	
205	E25NH74J35	Because some areas aren't kept pristine, they are not mowed but apart from that it is okay.	
206	YB27FDA73N	They seem to be all good around Cass Square.	
209	G784D2BM76	Everything apart from Cass Square is good. That needs to sorted as soon as possible.	
210	UJGEY57452	They cost a lot of money to run and they are kept tidy but the locals have to contribute as well.	
211	2635ES2B37	Cass Square has new matting in part of the playground. They need to tidy up on the bigger kids side. It's not nice for older kids, the bark has turned a bit mucky. The picnic tables are great, the skate park is great too.	

215	6Q6KD7CS2Y	I think some of the children's play equipment could be updated. I would also like to see an adult playground like they have in England. It helps in coordination and its fun!	
216	7EPNE68RL3	They do a good job.	
217	SF7VK83VLX	I consider the sunset point development very good. Cass Square is always very tidy.	
219	PX4U2527J7	Because it is always neat and tidy and things are cared for and there is nothing unsafe there.	
220	JWG88HH5R6	Well maintained.	
222	J3J5245PKG	I think they could spend their money better, they are okay.	
225	R4866LMG46	They are fit for purpose.	
230	8T73352N2S	I often go for a walk in the parks and Hokitika Gorge. I also do the treetop and I regularly walk Cass Square. I really like it. I really enjoy it.	
231	MA3MNV5G6K	There are not enough rubbish bins.	
237	34R44PR7BC	I think they are well presented. I like Cass Square and it is reasonably well looked after.	
241	6JTWG57DQ7	They are accessible and I like going there.	
242	N86ER5Q8N6	They are in good shape.	
243	Y7E4F7GX3V	They are not well maintained by the Council, the Council are meant to fund it. The locals look after the reserve.	
244	F43TESSLWC	Ours are maintained by the local community.	
246	FXJWRQGK66	Cass Square is neat and tidy but they took all the colour out of it in relation to the gardens. They had beautiful hydrangeas and took them all out.	
248	8D6PWJ342N	They need to work on Cass Square.	
249	35APA22B6C	They pulled out all the hydrangeas.	
251	32J3D3NDE7	Cass Square could have some little improvements. They pulled a war monument down and should put it back up and restore it.	
252	X8KEV73H64	I can't take my dogs. There are no dog parks here, I would like one.	
253	K3VH48J5G5	The workers take an interest in their job.	
254	5H7T368E7Q	Clean and well looked after, no litter.	
256	3678C7S5DJ	Because there is too much money being thrown away.	
257	F5TAMAFTFM	They could probably do better.	

258	57BVPQ3LG5	They are always clean and tidy and well presented. The lawns are always manicured.	
261	PU7K2T856P	They seem to look after them most of the time.	
262	87M8D3Y3XA	They are nicely maintained.	
264	6825K3434Q	Everytime I go there, there is always a seat that I can sit on and it's clean.	
265	4JKD4LBAG5	Because a lot, (Cass Square is alright), of the others, are not particularly tidy. They have a heavy reliance on spray which I don't like and they spray the roadside when all the kids are getting out of Kindy.	
266	B8PAL2GC2E	I am happy with the parks.	
269	4W2J56W854	Its easy to get around and I don't get tired of looking at it.	
270	7SBT545PMM	Clean and tidy. No overflowing rubbish bins.	
271	J42P5854WQ	The parks and reserves are in good order.	
273	4M38RHG62Q	The parks I have visited have been well maintained and clean.	
275	88U48N2668	They are conveniently close by for me.	
276	W8AQ5R67Y2	I think the parks and reserves a lot of them are not looked after like they should be - the lawns aren't mowed that often, the gardens aren't weeded that sort of thing.	
277	Y73Q3CU7W6	They were neat, tidy and clean. There is no rubbish around and the grass is mowed.	
280	2437XK4KYJ	There need more maintenance.	
281	PENY3T2G66	Some of the children's playing areas could be updated and tidied up.	
283	FSK7TSGQT5	They seem to maintain them very well.	
287	K5JSH84Y3N	They are pretty good, good parks. Cass Square is a work in progress and needs upgrading.	
288	X8TPY5L4Q4	I find them clean and tidy. They are functional and a nice space to be in.	
290	8UXTAV88UK	A dog park would be good to have.	
291	5MK7TD7M47	Cass Square, it was nice and tidy.	
292	7S55GJ58HV	They are great.	
293	L5NNC43B46	Cass Square hasn't been maintained. It's slippery, it's not fenced.	
294	JWBMH76AQ8	They are well maintained.	
297	KCU5S46U5E	It's like the footpaths, disgusting. Cass Square is okay.	

298	QB5E7J77DV	They are doing a pretty good job with mowing and keeping things tidy.	
299	22538TJ3D8	We only have one park and we only have one reserve and I think we need another one. Cass Square has a lot of events held there and in the past they have had to delay different types of sports, like rugby after the wild foods - when the rugby can't get on until the beginning of April.	
301	688P4R4224	I have seen tourists out there all the time and they rave about them.	
302	763D7YL82Y	They are always at a certain standard. Sometimes they could be mowed a bit more but the weather gets in the way, I think they do the best they can.	
306	DDV2HT7C22	They are tidy and no complaints.	
308	QD3TK637P7	Cass Square is great, I am pleased with it. It is tidy and the lawns are always done.	
312	G55LA65TF3	They are nice and tidy and well kept.	
313	FT6N23445V	I am disappointed they cut the lovely shrubs away in Cass Square. We haven't got a park and this is disappointing.	
314	343E225W2S	I don't think they are kept as well as they could be.	
315	7D3VG8X728	There could be more improvement such as the parks. One playground needs new matting.	
316	6323R7V86N	Sunset Point - the parking is the wrong way around.	
318	H6NLEH4DGV	Cass Square is nice and clean and kept tidy.	
321	T3Y8W7A4B7	Some of the walk ways are badly in need of maintenance and others are good.	
324	332RC574B4	No comment.	
325	W8AGL24Q65	They do a bit of rugby on Cass Square and there is a bit of prickly weed in there and it's not great for the players. It would be good to get rid of it.	
327	55V334QH5E	I don't go to the parks much so I am not sure what they are like but Cass Square is nice and they have a nice children's area and a skateboard area.	
329	22XLP75L26	There are not that many places in the town where you can sit under trees or walk through. Cass Square is kind of sparse. There is not as much as there could be in that area in the way of trees and plants.	

331	RR6V368W5C	They are a few things that could be tidied up.	
333	8Q2HQW3NU7	Cass Square is well maintained. Other parks are in crying need of maintenance that hasn't occurred in 20 years.	
336	282L73HFGF	They are pretty good.	
337	V658BR7F23	They have done well with Sunset Point.	
338	M53YV7APJK	Cass Square is mowed. I'm not impressed with the Racecourse they have purchased.	
341	76YESW52T7	Some of the concrete is not level at Cass Square.	
342	6W7D633T4E	Cass Square - they dug out every flower, I would have rated it a 10 before, now it's awful. There is not one flower left. Some of the shrubs were planted 40 years ago. The children's playground needs upgrading. I think people are stealing things from the playground.	
343	H6568442JC	The Heritage Trail - I am disheartened about that, it hasn't been fixed and I have asked the Council to do something about it.	
345	7EV5S734X5	They had everything that I needed, they were clean and tidy, well maintained and it felt good to be there.	
347	36XK3J4467	There is ongoing maintenance required.	
348	WQ5ENR277V	They are good and tidy. Cass Square, some of the equipment needs replacing.	
349	77YE28M733	There could be more work done generally.	
350	2RB5EH467J	No particular reason but I don't think they are quite up to a 10 scale but they are reasonable.	
351	P338684522	Nice and tidy, well laid out and accessible.	
352	4X36NBL46B	I think there is a lot of parks and reserves and they are well maintained and the tracks are good etc .	
354	L2J538668W	Dog faeces is my only issue which is on the owners.	
355	GN3AG8WR23	The parks are pretty good and well maintained.	
356	J2WDW8LUR2	They are very well maintained and looked after.	
357	6KG4BGW5B8	They are attractive, it makes you want to go back again - Thomsons Bush and I like the kids park too where the old scout hall is, they have done a lot there for the kids and big kids and it is mostly tidy.	
358	32SVGKB8P7	I been to a few reserves. We don't seem to get a lot of back up from the council with maintenance of the reserve area.	

359	4HE3TK7VYL	Whitcomb Terrace needs more tidying up and planting.	
361	5MK2M5TDNU	I don't like the way they chopped down lots of trees at Cass Square. They spent a lot of money on the rugby park but it still gets very wet.	
362	325NDUN472	The beach front is very tidy and well presented.	
363	82CWA4CV25	They are all pretty good. Green spaces to be able to go to.	
364	256AG8Y5H6	Cass Square is not perfect but it's okay.	
365	7CAPDJ8M83	They are usually pretty well kept, like mowing and weeding and that sort of thing.	
109	KA82BEBU26	Well groomed.	
110	3757SPASR8	Like the opportunity to have green open spaces. Sometimes maintenance (mowing, weed spray) is needed.	
111	MJG8F4JV43	Upkeep is good.	
113	3GTK5ESA84	Walking tracks had been in an extremely poor condition for years. Heritage Trail by the Racecourse - recently upgraded.	
117	35A5E3548G	The parks are kept in good order.	
120	UP62Y7LN68	Good facilities.	
121	778WAA26CB	Kept tidy.	

ID	RC	Q9. Could you please tell me why you feel this way? - Public toilets	 Index
5	LW76DQBE76	It is a toilet, not an art gallery. My needs were met.	
6	8RPPR24Y7T	Clean and tidy.	
7	P666QY85R2	They were clean and well maintained.	
8	GVX74254L7	Not particularly well maintained or clean.	
10	FDB8882NT5	Just a normal public toilet, don't expect much.	
11	MTCU476NKE	Sometimes they are locked and unavailable to use.	
13	H4RR2WK3J4	It did the job needed.	
14	54GBDSTCK2	The toilets down by both Hokitika and Greymouth river mouth's are superb facilities, and always nice and clean.	
15	NQJ27533B4	Toilets always seem very clean and have toilet paper and soap.	
16	FS75M2K5T5	I had trouble with a disabled person at the Ross toilets.	
17	55S8283EP8	Not very good disabled access.	
19	57Q7744356	Toilets by Carnegie Building were closed.	
23	6PW48NAX62	Very functional and clean.	
25	834ELHK644	No.	
27	PTBF52JTX5	Untidy and not clean that good.	
30	3KE5FH3P76	Always clean and tidy and well stocked with toilet roll.	
31	37GJ3775R2	Not very clean.	
33	TH2WQ55K88	When they are open it was clean enough.	
34	2383T8RB3Q	Toilets in Hokitika, Kumara and Ross seem to be well cleaned and maintained.	
35	LBBVEH73DC	The toilets I have used are clean and well looked after.	
37	X6332J56L5	The ones in Ross and by Museum in Hokitika well kept.	
38	64VAT555WP	The one at the beach front is good.	
40	54M86G63X3	Use all of the public toilets at various times when I am walking during the week - they are always in good order.	
41	5384P8T83W	The toilets were of average standard. Not dirty but not as clean as they could be. They also smelt like they were unclean.	
42	5DUN8473FX	Clean enough for a public toilet.	
43	BW23G6Y52S	Wheelchair toilet on Tancred Street - this disabled toilet has a self-shutting door. I've been here on crutches multiple times - highly dangerous as the door shuts on you part way through.	

45	R7658647RH	They have always been dirty, smelly and there doesn't appear to be any parent toilets with change tables.	
48	8VN8L8D53M	Pretty good but I suspect its done for the tourists, not the ratepayers.	
49	3666654NN5	Very clean.	
50	75UK66R6MG	Mainly use the ones in Hokitika and they are always clean and tidy.	
53	P3SWVQTWUU	All public toilets I have visited have always been clean, stocked with toilet paper and soap. Never have to worry about bringing my toddler in to a toilet. Great work!	
54	CTCL5YBCBT	Sometimes they could be better maintained.	
55	USRMSM38VW	Usually clean and often one around.	
57	VB8445N866	Experienced them locked, unloved. She'll be right, ask yourself, why these are tucked away like it's used by a minority, but is shows our thinking is locked in the past.	
58	6FDJXE4GDP	Well maintained.	
59	E87LH5NUE2	Hot water at Museum toilets is good.	
60	QTY2JPPT76	Clean.	
61	Q336266YNQ	Clean and tidy but not enough ventilation.	
62	A666XC43DA	Definitely need more care.	
63	23A22P6JC4	Public toilets kept fairly well clean and maintained.	
64	S2Y7GY6GC2	Beach front toilet door was unable to be locked from inside. The new toilet at Sunset Point has been placed in a very venerable position due to sea erosion. They would have been very expensive to build and get power to, plus the salt damage will make them very high maintenance.	
66	PMA6Q5Q7XW	The town toilet is fine, well placed, clean and tidy, but there's no other toilets!!! Need options near the parks!!	
67	WS6CSX32Q4	Clean and tidy, but could do with a revamp.	
68	R3X24YR7Q2	Good clean and tidy toilets in town with running hot water.	
71	UFK8ACBNBG	Mostly clean and tidy.	
78	3L37MQ3J26	Nearly A1, the odd thing only not there when required.	
82	R52SAB6L4H	Clean, easy to find, very good for visitors in the area.	
84	QV2YS76L5H	They are inclined to smell yuck, especially the old ones.	
86	4275JK5777	Kumara sports ground toilets are well maintained, however, some of Hokitika's are getting dated.	
90	AHL3R2QFJ6	The facilities in town are locked up, Tip Head, Cass Square. Pensioner rooms all closed up by eight pm.	

92	J7WD6524G2	Dirty.	
93	H5CRN8B7GM	Need upgrades, for example Kumara Domain toilets and toilet behind old museum are average.	
94	X4AEJK448L	Middle of town, one is disgusting.	
95	U3D5DBC48M	I am always surprised how clean and tidy they are.	
98	US7V7A5822	Their reputation precedes them. If you have to use them - you use them. I would like to see the public toilet to be cleaner than they look and smarter or more presentable (better Looking). Some glitter will do.	
104	66867BWNWM	Clean & Tidy. More soap would be good & need hot water.	
105	45E734TNM3	Clean, available and good position.	
106	A8B83P8VS8	Need to be cleaned more regularly & more maintenance required.	
107	MVHGWMD7CM	Harihari excellent, Hokitika appalling.	
108	4PA5GW2H54	I have found some of the toilets need to be worked on. They look untidy and maybe needs more cleaning.	
125	U7BU3K4CB5	Its, sometimes lacking in hygiene. One on Tancred Street.	
126	6274MWB7N2	Up keep more being unclean.	
129	5SG6RK6A7V	Reasonably clean. Leaking water an issue.	
131	VB7BP2867S	The toilets were new and well though out, clean and nice.	
135	52A4K3X883	They were smelly, no loo paper and always have stuff on the seats. I feel bad taking my kids there.	
136	PM83823Q2B	It was not good. Toilet paper and water everywhere and no paper to use or water to wash my hands. - by Dixon Park.	
137	456C72N8TN	It hadn't been cleaned, but while I was there the cleaner arrived.	
138	RAYC44BCYK	I went early in the morning and they were beautifully clean.	
144	8W7D635E82	The toilets are old in Hokitika but functional.	
145	X62662QKQK	They have modern toilets.	
146	662BB7TCJ3	The toilets were clean.	
148	6R6KE5AGH7	Usually okay, could be cleaner at times.	
149	BJ4326F584	Reasonably clean and tidy.	
150	UGL6JFM7Y7	Clean and well serviced. Not a place I am scared to go to - adequate.	
152	Y6C8838W77	They were a bit dirty.	
153	5EH446CCX7	They could be cleaner.	
154	5J7V6568U3	If was fine.	



156	B2H2YR82YW	They were clean and kept in good condition.	
158	DE6N88483X	They were clean.	
159	Y4T6SXN55X	They could do with some general upkeep, they are looking old and tired. Most of the time they are clean.	
161	P8H6A5Q4LM	They were clean.	
162	X2ERX738UV	Generally just old, needs an upgrade. Clean and tidy though.	
164	8X3E5NT22Y	They generally smell. They are disgusting some of the time. Sometimes there are no hooks on the doors to hang your bags.	
165	4XH8LS6SPB	Functional and okay.	
166	3347N64L6D	They are always clean.	
167	6SX7EY86P7	They are old (Hokitika) and need upgrading.	
169	2V6XP654K7	They are clean.	
172	CDJA4B5583	They are fine, clean.	
173	YH7YFVDJR5	They were dirty. No toilet paper. I don't think they are well maintained.	
175	K534CT2H2B	I think they are adequate and quite up to standard - clean and tidy.	
180	HLQ3E5E83V	There is always room for improvement in public toilets I feel.	
182	53FS6EY87H	Usually pretty good, could do with an upgrade - but usually clean.	
184	NS33G7VHR6	They all could be better, some have been done up and others have not been done up, they are satisfactory.	
186	2P54MQGM4U	Sometimes there is no toilet paper and things are broken.	
187	CJ35UW35XL	They are usually pretty clean. When I travel, I take my toilet cleaning stuff..	
188	L2D2PH22VE	Nothing wrong with them they are all good and clean.	
189	73EM4RJVB3	They are fairly new.	
191	27N784YF72	There is no maintenance and it needs a upgrade like painting etc. Fixtures had been moved in the toilet and the holes have been left unfilled in the concrete. As it looks so shabby it gets shabby treatment from people.	
192	UJAREF753S	Clean and tidy.	
193	67R33EN3J2	They are quite good in Hari Hari.	
196	46C754P4NL	It was probably recently cleaned.	
197	PAU87M336U	It could have been a bit cleaner. It needed more maintenance and cleaning.	
198	5N242MY7M3	They clean the toilets twice a day in Kumara. I cleaned them myself this morning. I am the caretaker of the Kumara sports group and we take care of the public toilets in Kumara.	
199	858455DF8Q	They were quite old but cleanish.	

200	PKL6V82LAQ	The toilets were not clean, particularly during covid times.	
201	8Q78GWK2J7	By the museum, not clean and not hygienic and always stinks. Doesn't always flush.	
203	43GWDN347K	Campers use it, there was no toilet paper and a broken lock on the door.	
204	L2N2APH5X4	Ninety-nine percent of the time they are pretty clean.	
205	E25NH74J35	Because they are clean.	
206	YB27FDA73N	They weren't very clean, not very tidy, in need of an upgrade. The toilet near the Museum. Hari Hari toilets are brilliant. Hokitika ones are not good. Whataroa ones are good. Fox toilets are nice. I travel a lot so I use all the toilets.	
209	G784D2BM76	Pretty clean.	
210	UJGEY57452	Sometimes they are quite dirty with no toilet paper and one is blocked so there is only one to use.	
215	6Q6KD7CS2Y	The toilets need better maintenance and they need to be cleaned more regularly.	
216	7EPNE68RL3	The toilet was tidy and organised.	
217	SF7VK83VLX	There are plenty of them but sometimes they smell bad.	
219	PX4U2527J7	They were modern toilets and did the job well. Well situated.	
221	P22B484432	Some of the toilets needs upgrading for e.g. the ones in Hokitika.	
222	J3J5245PKG	Very good, clean, always open.	
223	44C4274N37	When I have used the toilets they have been clean.	
224	B2VV7VAC66	Nice and clean.	
225	R4866LMG46	It was clean and tidy.	
231	MA3MNV5G6K	There are not enough toilets. Port a loos are put up for freedom campers who don't pay any rates but no toilets for the ratepayers.	
234	2K5UUH3A38	The public loo in Hokitika - the way it is cleaned is terrible - cigarette butts and bits of toilet paper are swept into a corner and left there it is terrible.	
237	34R44PR7BC	It was tidy and reasonably well looked after.	
244	F43TESSLWC	They were clean.	
245	B7MCC3GU75	The ones at Hari Hari are alright while there is no tourists.	
247	V22F86J7W7	They were very good and clean.	
248	8D6PWJ342N	The new ones in Ross are excellent. 10/10. They ones in Cass Square are a bit grotty.	
249	35APA22B6C	The toilet that I used was clean and well stocked.	
252	X8KEV73H64	The toilet was filthy (not the one by New World).	
255	533KA6HWM7	They weren't that good and a bit smelly.	
258	57BVPQ3LG5	Always clean.	

262	87M8D3Y3XA	There was lots of vandalism.	
263	4L27755LQV	They are in good condition, they probably need a few more in a few places.	
266	B8PAL2GC2E	The toilet at sunset park point had the lock broken but the ones at the beach are good.	
268	K3753624GS	It is always clean and everything is up to date.	
269	4W2J56W854	Toilet is always clean.	
271	J42P5854WQ	It was clean and tidy.	
272	78AE8KNQH2	They are clean and well looked after.	
276	W8AQ5R67Y2	Most of the time they are clean. I do think that Hokitika needs a good set of new toilets in the business district.	
277	Y73Q3CU7W6	The toilets that I used were clean and tidy.	
279	BRT5377RB2	They always seem to be clean, have soap, toilet paper and towels.	
281	PENY3T2G66	They are usually very clean when you get in them. You have to have clean toilets.	
285	7Q7LA43835	They were very clean.	
287	K5JSH84Y3N	Great toilets.	
288	X8TPY5L4Q4	More regular maintenance or some fragrance put in them.	
289	CQB8C3BW84	I used to work for AlSCO servicing them and I just think a few of them are getting a bit old, they need painting up and concrete floors, a refurbish.	
291	5MK7TD7M47	They were smelly, not as clean as they could be.	
292	7S55GJ58HV	They could have been cleaner.	
293	L5NNC43B46	They are not great but also not bad.	
294	JWBMH76AQ8	They are locked often and not always clean.	
295	3VV67QH5QG	They are not very clean, not too bad.	
296	L28C2QV6P4	I would give one lot of toilets a 10 and one a 4. The low rating is for the Hokitika toilets, they are often smelly and don't look clean.	
297	KCU5S46U5E	The toilets are disgusting. (By the Museum).	
299	22538TJ3D8	Because I think they are cleaned every night or morning and they are pretty good.	
301	688P4R4224	It was satisfactory clean enough.	
302	763D7YL82Y	We were down at the beach right next to the toilet block and they locked it. It was a function with about 20 people and they never asked if we wanted to use it or anything. It was the day after the Driftwood and Sand competition and there were a lot of people at the beach and it shouldn't have been locked anyway. It was the toilet block by the ship.	
308	QD3TK637P7	They are always lovely and clean.	
310	6BQ3VTVMNU	I went there one day and didn't know where to walk the floors were disgusting.	

313	FT6N23445V	They were clean.	
315	7D3VG8X728	By Sunset Point the toilets are nice and new.	
317	6E2588HW8X	The ground was so wet and not the cleanest.	
320	BC26P2B2Y2	They weren't clean.	
321	T3Y8W7A4B7	Generally clean and tidy.	
322	R5PYBLW726	It was reasonably clean and well presented.	
326	7WN6EF6QR6	They were clean.	
329	22XLP75L26	They are pretty good, I haven't used them enough to make any more comments.	
330	RXGE7NGN6F	They need tidying up - updated.	
333	8Q2HQW3NU7	Pretty tidy and well maintained.	
335	546WDMFKVS	One or two of them are bloody atrocious. Others are good and clean and others are well past their used by date.	
337	V658BR7F23	They were not that clean and a bit smelly.	
339	HG7T57JP7N	I think all public toilets are smelly and gross, this was reasonable.	
341	76YESW52T7	They smell.	
342	6W7D633T4E	They were very clean, a bit old though.	
344	264YR7VM6W	The times I have gone in I have found the toilets that I use clean and tidy.	
345	7EV5S734X5	Dirty, smelly. Not all of them were unlocked. There was one that was locked and it made you wonder why they locked just one.	
346	A62R6KJA5T	It was nice and clean.	
347	36XK3J4467	They are not great. Sometimes they are not clean and just generally rough with damage.	
348	WQ5ENR277V	They are not always open, but general clean.	
350	2RB5EH467J	Sometimes it smells quite badly. The smell has got into the concrete. The good thing about the toilets is they have hot water.	
351	P338684522	Some of the locks on the toilets at Sunset Point don't work.	
352	4X36NBL46B	It was relatively clean and tidy but there was a bit of water around, hopefully, that was because it had just been cleaned.	
355	GN3AG8WR23	Pretty good compared to other towns.	
356	J2WDW8LUR2	Always clean when I go in.	
359	4HE3TK7VYL	I believe they are good and clean.	
362	325NDUN472	They are not flash, just fine, clean enough.	
364	256AG8Y5H6	They were clean.	
69	4JAS5KYASF	Clean but smelly.	

109	KA82BEBU26	Not always clean.	
110	3757SPASR8	Not always open, and for an out of towners this is a problem. Need upgrade (i.e. ones by the museum & Square). Toilets are too old.	
111	MJG8F4JV43	Poor condition, and cleaning is of a poor standard, i.e., not clean when you're the first person in after the cleaner.	
114	NQKM2PKP8M	Not too clean.	
116	JXBBW63T4W	Could be cleaner sometimes. Not always enough soap.	
117	35A5E3548G	Of the ones I have used, I found them to be well-serviced.	

ID	RC	Q12. Could you please tell me why you feel this way? - Library services		
1	2XRMG654MU	Great range of books and very efficiently operated.		
2	X25A3345RD	The question is mandatory; the answer isn't.		
8	GVX74254L7	Reasonable library in Hokitika.	Index	
11	MTCU476NKE	Went to a holiday program with children and it was lovely.		
14	54GBDSTCK2	Only went there for a Covid enquiry and the lady staff member was most helpful.		
19	57Q7744356	Shortening of opening hours not acceptable.		
20	P73DLWYA36	Good reception from staff and a nice light and airy space.		
24	QRHC76CTH3	Don't have an issue with the library service, it's a very good library for the size of the town.		
26	6YAR5TG72H	Most helpful, knowledgeable and welcoming staff. Lots of books and a continuous supply of new ones. Can access JP if needed. They provide lots of community based courses etc including easy access for learning computer skills. Very welcoming atmosphere and highly used by visitors as well as locals.		
30	3KE5FH3P76	Good facilities.		
32	6D48LD2S7S	Pleasant surroundings, availability of books and kind helpful staff.		
34	2383T8RB3Q	A good library that provides a wide range of reading/research options.		
37	X6332J56L5	Been using online service, excellent.		
38	64VAT555WP	Up until recently I was happy. However, now vaccine passport requirements mean I can't use the library to take my two small children and I'm not impressed. The council has chosen to openly discriminate against me and my family for our medical choice, when they have not been mandated by the Government and other areas, i.e. Gore District Council is allowing anyone into their library facility, I know as I visited this area recently.		
39	35C2553333	They are great.		
40	54M86G63X3	The staff are absolutely brilliant - very helpful and knowledgeable. I particularly like that children and young people find it an environment they like spending time in. The JP service is very helpful - and I think the events at the library are well curated.		

41	5384P8T83W	The team at the library are absolutely amazing. They're so friendly, helpful and very knowledgeable. They go above and beyond, offer a range of services which are so very valuable to our community. They're open to suggestions and often implement them. They're always getting new material in which is current and relevant to todays society. They run workshops and events. which more people need to attend, they're well worth it!		
42	5DUN8473FX	Lovely library. Excellent communication about what's going on with activities provided and where they're at with functioning around Covid.		
48	8VN8L8D53M	Given our size and population we have a good library facility.		
54	CTCL5YBCBT	I am satisfied with the helpful service and assistance provided.		
55	USRMSM38VW	Very accessible and good information and customer service.		
58	6FDJXE4GDP	Great service and well kept. I just wish there was a bit more of a range.		
59	E87LH5NUE2	Only used Hokitika which is easy to access.		
62	A666XC43DA	Great staff and awesome space.		
63	23A22P6JC4	Great library services for a small town like Hokitika.		
65	7AECJ6CLPB	As an older person it is great to be able to get decent reading matter.		
66	PMA6Q5Q7XW	Always lovely, friendly service. Great selection of books, easy to find things and it feels welcoming.		
78	3L37MQ3J26	Polite, knowledgeable staff and good range of material.		
83	EAA37W4P2P	Friendly, helpful service.		
86	4275JK5777	Fantastic summer reading programme.		
93	H5CRN8B7GM	Great staff, helpful, knowledgeable and courteous.		
95	U3D5DBC48M	A good selection of books, well kept in good order.		
96	435XJ8MA3Q	Staff are excellent. There is plenty of variety.		
98	US7V7A5822	Good for the mass population. Staff helpful. Good range of books, but would like more specific books e.g. fish in aquatic home tanks.		
105	45E734TNM3	Just fine, good service.		
107	MVHGWMD7CM	Staff work hard to ensure that the library can accommodate all walks of life on the West Coast.		
127	7RLRWB7TC4	Perfectly adequate, good range of magazines.		
128	7BTPY766AV	Good service but the hours are not good, closed from 12 to 2 which is not good as people can't use the library in their lunch break.		

129	5SG6RK6A7V	Everything I needed was there, staff were helpful.		
132	VPV6WSQJ2E	Never had any problems with them.		
133	588EMC6GSB	I got what I needed but there was not a lot of support in relation to the computers. The service was not great.		
134	SK7L58GX5M	They are always good in there and there is always books available that I want.		
135	52A4K3X883	We can't go in now as we are unvaccinated.		
137	456C72N8TN	Always helpful because I am usually chasing books that they have to get in, and that's no problem for them.		
138	RAYC44BCYK	I belong to a discussion group and to access information to discuss at the group, each person has their own topic. I went to the library and the gentleman helped me with book searches and information from the internet. He was very helpful, I don't know his name.		
142	GV456A27S2	Sometimes there isn't a great selection but they do their best to get books in.		
143	6C4857423N	They didn't have a couple of books that I wanted.		
146	662BB7TCJ3	It's small and with limited stock.		
148	6R6KE5AGH7	The library is brilliant. No other libraries stand up to this one and I've visited many in different areas of the country, the staff are excellent and so are the facilities.		
149	BJ4326F584	They are helpful but I think it could be laid out better.		
150	UGL6JFM7Y7	Not a great range of books. We always have library books.		
151	W2UKV68JRB	Good selection of books and they will get books in.		
153	5EH446CCX7	They are helpful and are alright.		
154	5J7V6568U3	Neat and tidy layout and lots of care and attention. Friendly and helpful staff, a pleasant place to visit.		
156	B2H2YR82YW	I've been to different libraries and they are great. New books all the time.		
157	U6G75T53UA	They are good and helpful.		
159	Y4T6SXXN55X	I've always found them helpful. They don't have what you are looking for always but they get books in if I want.		
160	E82R52F8L7	They are always very polite and caring. I have no reason to complain. They will find books for me.		
163	2Q52T82HDR	The are good.		

164	8X3E5NT22Y	They are one of the best libraries I have been in for everything. I have no problem finding books, they are great.		
166	3347N64L6D	They are really helpful.		
168	Y866Q3LE68	They are very good, they have nice books.		
182	53FS6EY87H	Really helpful. I'm not computer savvy, so they help.		
194	M2W4876DV2	It would have been a 10 but due to covid there are restrictions.		
196	46C754P4NL	It is hard to put a reason. I don't use the computers there so I can't give it a 10.		
197	PAU87M336U	They have proven to be very flexible over time and they have many initiatives to extend the function of the library. The staff is very helpful and pleasant.		
200	PKL6V82LAQ	They are friendly, they are very skilled at dealing with clientele and the difficult to manage ones on occasion.		
203	43GWDN347K	The staff are so helpful.		
205	E25NH74J35	It is very easy to look and find what you want and the staff are very helpful.		
208	R26622CD56	We have a small library at Haast. Our library is very small and in a room in the local hall. They used to send us books until our librarian died last year. A group of us are trying to sort in out. Council will only send the books down if we pay for the courier. They have offered to give us their reject books.		
215	6Q6KD7CS2Y	I think they have a great selection of books and they are happy to listen to suggestions about new books or anything else. I really appreciated the class they had to teach us internet banking.		
217	SF7VK83VLX	I like their online audio book catalogue.		
219	PX4U2527J7	They offer a variety of books and when I was downsizing, they were happy to take some books about the area and they were well received, they are a good crew, good on them.		
220	JWG88HH5R6	Perfectly fine. Good selection of books, Helpful staff.		
229	B66QWYY5A3	They are so wonderful and it's easy to find my way around. When I can't find a book, they get it in for me.		
230	8T73352N2S	They are very helpful and pleasant to deal with. I go down to the library probably once a month.		

231	MA3MNV5G6K	They have a good selection of books and magazines and the staff is helpful.		
232	W2846MBGT6	They are a great lot and very obliging.		
236	FLQ7SE3Q7W	They are amazing and will help look for books and order them in.		
239	C6XTP2S2VT	I like the service.		
241	6JTWG57DQ7	The staff are very friendly and helpful.		
242	N86ER5Q8N6	The service is absolutely top notch. The staff and facilities are exceptional.		
246	FXJWRQGK66	They are always helpful and everyone is helpful.		
248	8D6PWJ342N	They are awesome. The staff are great and the best asset to the Council.		
249	35APA22B6C	The service and the books are good.		
252	X8KEV73H64	Fabulous. The people are great.		
253	K3VH48J5G5	The staff are lazy! I think it's overstaffed. The lady called [REDACTED] works there who is paid to do nothing because I heard her say that her pay was money for jam. There is an old boys club.		
254	5H7T368E7Q	They are always good. We are well looked after.		
257	F5TAMAFTFM	I am in the middle. I don't use it very much so I can't really say.		
262	87M8D3Y3XA	The staff are very lovely, a great selection of books. Well ventilated.		
264	6825K3434Q	They have what I need and if not, they get it for me.		
266	B8PAL2GC2E	The staff are good and friendly. I walked in a few minutes before they closed and they were still willing to help me.		
268	K3753624GS	There is a good availability of books and a good variety. The staff are helpful.		
274	UG7P765663	Good service and plenty of books and easy access. Hokitika Library.		
276	W8AQ5R67Y2	The staff is always good. The set out is lovely. I don't think they should move it into that other building.		
277	Y73Q3CU7W6	I was very impressed with the service I was given.		
281	PENY3T2G66	I use the library for the grandchildren mainly and they were very thoughtful and put craft packs together for the children during the lockdown, things for them to do.		
285	7Q7LA43835	We have a small library here in Okarito, it's only open for a short time.		
292	7S55GJ58HV	The friendly and efficient service.		
293	L5NNC43B46	I love it but they are closed in the middle of the day.		

295	3VV67QH5QG	It's a good service.		
303	3NQ5V6US48	They usually have what I want if I look hard and long enough.		
306	DDV2HT7C22	Great service, but I can't go at the moment.		
307	B5CULLP7AY	They are pretty good and very helpful. It's well run.		
308	QD3TK637P7	The give excellent service and they are always willing to help you.		
313	FT6N23445V	I'm disappointed in the cut back of hours but the service is great.		
314	343E225W2S	The staff are good. One gentleman there is very helpful.		
316	6323R7V86N	They have all the books and the offerings I am happy with.		
323	7L8Q227KQN	They need more big print books.		
325	W8AGL24Q65	They are friendly and helpful.		
327	55V334QH5E	They are always very helpful and cheerful and they try and get my books for me if they are not in the library.		
329	22XLP75L26	It is pretty good - I like the librarians, they are very helpful. I like the newspapers to read and the new books that are relevant, that you want to read.		
330	RXGE7NGN6F	You can go in there and relax and have a quiet time, read the paper or whatever. I can also learn about my cellphone or computer.		
338	M53YV7APJK	They did the job I wanted.		
340	6R84Y8YQH7	It's 10 x 10, they are absolutely wonderful. They are great and help get books and choose them from your reading list.		
345	7EV5S734X5	They are always very helpful. Plenty of choices and they offer lots of extra help.		
347	36XK3J4467	They are good. It's a really nice space to sit in, the location is good and it's always clean and comfortable.		
351	P338684522	They have a great selection of books and the staff and so lovely.		
352	4X36NBL46B	I think they have a wide range of books and resources available and the staff is always willing to help you find something and their email communication is really good.		
354	L2J538668W	They are always very helpful and it is a clean and friendly environment and they go out of their way to help you.		
355	GN3AG8WR23	They are pretty good. They were very helpful.		

357	6KG4BGW5B8	They are always welcoming and willing to help you find what you are looking for and it is quite a friendly place to go to. I can remember the days when you went to a library and you were not even allowed to whisper, things have certainly changed over the years, thank goodness for the better.		
358	32SVGKB8P7	They give a good service.		
361	5MK2M5TDNU	They do an excellent service and they give me access to lots of audio books.		
362	325NDUN472	They are very good. Good range of books.		
363	82CWA4CV25	They are amazing and helpful, pretty good. They answer queries and have computer services for people to use - Hokitika Library.		
364	256AG8Y5H6	It's a bit noisy but apart from that, it's all good.		
109	KA82BEBU26	The service and the quality of books. The staff are amazing and very knowledgeable.		
110	3757SPASR8	Always friendly and helpful. Premises is clean and stimulating. Great community service.		
113	3GTK5ESA84	Staff were helpful. Great service that was free. Good selection of books.		
114	NQKM2PKP8M	Don't read books but use papers for information and electoral rolls.		
115	ACPMLUKMGU	Good variety of books and papers.		
116	JXBBW63T4W	My money and my health was good enough at Level 2. I love our library. I think the library staff are awesome. I feel annoyed that the Council and Gov't. have stopped me accessing library at red traffic light. It's no different to going to a shop so why am I segregated when I haven't had a vaccine? I pay my Council rates on time annually and in advance. I do not deserve to be treated so poorly. The provision of books at Red I am grateful for contactless service but I feel discriminated against for choosing to avoid a vaccine that could affect my autoimmune conditions negatively.		
120	UP62Y7LN68	Great service and good selection of books.		
121	778WAA26CB	Staff are very helpful.		

ID	RC	Q13. Can you please tell us why you have not used any library service or visited a library in the District in the last year?	 Index
3	3H82BQQKQ4	I've never used the Library. Not a reader.	
4	U2224FFPK8	No books needed.	
5	LW76DQBE76	Your previous question did not ask if I had visited a library. I do visit the library, when it has some books I want to read, then I will use the service.	
6	8RPPR24Y7T	It is too far away from where I live.	
7	P666QY85R2	I don't need to.	
9	7LR78WY7B5	I don't read.	
10	FDB8882NT5	Information is available online.	
12	K6P56EEH6H	Why, when you have the internet?	
13	H4RR2WK3J4	Too busy to visit, but the local school has a library that's like 10 minutes from me. Hokitika library is about 1 hour away.	
15	NQJ27533B4	Not sure, probably should utilise it more!	
16	FS75M2K5T5	No time.	
17	55S8283EP8	Don't require the service.	
18	HF23E8B8GJ	No need to.	
21	VNUSJ4AV65	I read books online.	
22	6W5B6W3TVB	Cannot be bothered with the Covid rubbish.	
23	6PW48NAX62	Have not had a need till now.	
25	834ELHK644	No.	
27	PTBF52JTX5	Did not need to.	
28	825AVGB5PR	Lack of new/interesting fiction. Seems very old and not much of variety. Total number of books is low.	
31	37GJ3775R2	Use my computer.	
33	TH2WQ55K88	No need to.	
35	LBBVEH73DC	I have an injury which limits the amount of sedentary activities I can do.	
36	65C628644P	I haven't needed to.	
43	BW23G6Y52S	Have not been welcomed without a vaccine pass.	
44	VH5435CYW4	Work 7 days a week.	
45	R7658647RH	Haven't been reading much lately.	
46	36P84B53VW	Not a big reader of books and most other services can be found online.	
49	3666654NN5	Because I don't read too many books.	

50	75UK66R6MG	Just haven't had a reason to use, not a great book reader but do subscribe to some monthly and bi monthly magazines that are of my interest, my wife does use the Library on a regular basis and would most likely get 2 or 3 books out a fortnight/3 weeks.	
51	64W5L87428	Get everything I need online.	
52	YU2F24Q23F	We live half an hour away from Hokitika and it is difficult to schedule visits around school hours.	
53	P3SWVQTWUU	Only moved here last year, and haven't got around to it yet, but I plan to join and make use of it.	
56	36G43R3455	Can't be bothered with all the covid and mask wearing.	
57	VB8445N866	No need, all I need is at my finger tips.	
60	QTY2JPPT76	No need. Can find everything I need on line.	
61	Q336266YNQ	I do my reading online.	
64	S2Y7GY6GC2	I don't read a lot of books, plus I'm very unhappy that the library was ever located there due to the high rental paid each year and that all the mods required for it to be used as a library were paid for by the rate payer. the library was fine were it was originally located.	
67	WS6CSX32Q4	Was studying so did not have time for recreational reading.	
68	R3X24YR7Q2	Do not have time to read books.	
70	J2W528644C	I don't need books.	
71	UFK8ACBNBG	Covid.	
72	3TJLD43C8W	We buy books from op shop and can read at our own leisure.	
73	Q24NQD6RMV	No time to read.	
76	8S22F78CX3	No reason.	
77	VL6D76V6X3	I don't have time and don't need to.	
80	5UGX3A3K2B	Haven't been there.	
82	R52SAB6L4H	I buy books online or purchase books locally, Christchurch.	
84	QV2YS76L5H	Not a great reader.	
85	T22BQ7D3N8	Read online.	
87	8824AJTSDK	Trouble reading Daily Paper, let alone library books.	
88	876F2CB5K7	No need to.	
90	AHL3R2QFJ6	Been busy.	
91	F58EP6T55W	Had no need.	

92	J7WD6524G2	Have you heard of the internet?.	
94	X4AEJK448L	Use online services now.	
97	HG6F35S4X5	Opening hours do not suit my working hours. Unable to get card issued as my existing one has expired.	
99	ETL3AD4E5J	The current mandate - plus could not sign up at library. Had to go online first which I keep forgetting to do.	
100	8F5658NRTP	Lack of time, active in sport and service club.	
101	B77M46MPX2	Don't use libraries.	
102	6T5FUTUW6A	Have my own books and hobby's as well a the internet.	
103	JH3MK5S3P2	It has been open, and closed. Internet is reliable.	
104	66867BWNWM	We use online & Greymouth.	
106	A8B83P8VS8	Have had no need to.	
108	4PA5GW2H54	Too busy.	
124	LQ7G3766CV	I use the internet.	
125	U7BU3K4CB5	I do not go to town very often, I tend to do a lot of stuff on line and I have got a tonne of books at home any way. My friends and I have a lending library and shy away from public areas at the most.	
126	6274MWB7N2	I've got books but I don't read a lot.	
130	3QJ5765K85	I don't read.	
131	VB7BP2867S	Never get time to read.	
136	PM83823Q2B	It's always closed when I finish work.	
139	2EH4T6A26C	No need to.	
140	WV2J8J2HSV	Too busy working.	
141	57HB4847V2	Don't seem to have what I need.	
144	8W7D635E82	Not a library user.	
145	X62662QKQK	I enjoy looking at the TV.	
147	T84558QRTP	Don't like reading.	
152	Y6C8838W77	Don't use this service.	
155	FVC3Y4G33S	Don't need to go.	
158	DE6N88483X	I don't read much.	
161	P8H6A5Q4LM	Don't read much.	
162	X2ERX738UV	Use google, don't read books.	
165	4XH8LS6SPB	Don't read books.	

167	6SX7EY86P7	I don't have time to read.	
169	2V6XP654K7	Too busy with work on the farm.	
170	426C258U5E	Never have done.	
171	J4KY6P3YKD	I have enough books at home.	
172	CDJA4B5583	Time and don't get a chance to get to the library. I mostly use the internet.	
173	YH7YFVDJR5	We have started our own book club.	
174	AWW62AQ34M	Don't have time.	
175	K534CT2H2B	I am not beckoned to reading those sort of books - heaps of people do use it around here but not me.	
176	P286JRDW4W	The hours don't suit, so I don't get the opportunity. I access what I need on the internet.	
177	4SQBVG847R	Don't read.	
178	8B2HAF777F	I teach at the High and use their books.	
179	WKM64FDYKK	I don't read much.	
180	HLQ3E5E83V	I am not a big reader, I have never used the library full stop.	
181	WH84K66K5T	Got too much else to do.	
183	2QQ6HFW3FB	The times are difficult.	
184	NS33G7VHR6	I have no books I don't use the library.	
185	K483R3C875	Never get round to it.	
186	2P54MQGM4U	I haven't had time. Stay at home mum with six kids.	
187	CJ35UW35XL	I do a lot of research online. The times don't suit me.	
188	L2D2PH22VE	I get everything online.	
189	73EM4RJVB3	I don't use libraries.	
190	S8JCE8N2L4	Because of Covid I can't be bothered with all the masks and signing in etc.	
191	27N784YF72	No reason.	
192	UJAREF753S	I don't read.	
193	67R33EN3J2	I don't read much.	
195	DT28MAD2M8	Just don't read.	
198	5N242MY7M3	I am not a reader.	
199	858455DF8Q	Everything I need I google.	
201	8Q78GWK2J7	Don't have time.	
202	TU68W437D4	Don't have one near me.	
204	L2N2APH5X4	I don't read much.	

206	YB27FDA73N	Didn't get around to going.	
207	3HJCND837D	Because I am not registered to use them. I don't want to go there while Covid is around.	
209	G784D2BM76	Too busy to read.	
210	UJGEY57452	The main one in Hokitika is 80km away but there is one at the Whataroa School but I tend to just swap books with friends.	
211	2635ES2B37	Years ago they charged for a book I had returned and I have never been back. They didn't care to discuss this and I haven't been back. I put it in the slot and someone could have stolen it?.	
212	BNSVGVR5H2	I don't read.	
213	4UG22H6577	I haven't got a card and I don't go out very much.	
214	5JT884783L	I don't read. I like watching TV.	
216	7EPNE68RL3	I want to keep away from people.	
218	XTE4DV4N67	I am not a member of the library and I don't do much reading these days.	
221	P22B484432	I don't read.	
222	J3J5245PKG	Too much on TV and I have a kindle.	
223	44C4274N37	I don't read.	
224	B2VV7VAC66	I don't read a lot.	
225	R4866LMG46	Due to covid.	
226	2448LYU6C4	I don't read books.	
227	VLK4277643	Don't read a lot.	
228	Y8VS5DP4QX	I have my own books.	
233	6N823PSCYD	As I tell you I am 93 and I only just go where I have to go in a taxi or friends take me and sometimes I am not well enough to go. I never have bothered with the library even when I was young.	
234	2K5UUH3A38	I have mobility problems and I have a kindle that is chocker full of books.	
235	K3E36JQ554	I have never used a library in my life and not going to start now.	
237	34R44PR7BC	I just don't read a lot.	
238	535236444W	I used to use the library but have no time at present.	
240	H45DR6Q7CL	I have trouble reading.	
243	Y7E4F7GX3V	I'm not a reader.	
244	F43TESSLWC	It's too far away and I have a kindle.	
245	B7MCC3GU75	I am a big reader, the library is a bit far away.	

247	V22F86J7W7	Haven't been yet.	
250	36D8F2U42H	I hardly go to Hokitika.	
251	32J3D3NDE7	I don't read books.	
255	533KA6HWM7	I don't read much.	
256	3678C7S5DJ	It is not my thing. If I want to read I will go and buy something at the book shop. I am not a fantastic reader anyway.	
258	57BVPQ3LG5	Because I work in mental health away from Hokitika and I am never here when it is open.	
259	CT6N53CTB5	Because I now have no car and I am too far out.	
260	8W243TKGVU	I don't go anywhere and I haven't got time.	
261	PU7K2T856P	I got a lot of books from the last bookorama.	
263	4L27755LQV	We only have a small library here it is only open one day a week and it seems to be random when it is open. If it was open consistently it would be better but there just doesn't seem to be any specified time that it is open.	
265	4JKD4LBAG5	Haven't had time and I do tend to buy my books but I used to be a prolific reader of the library.	
267	4AAETXCE52	I have been reading on my phone.	
269	4W2J56W854	I have books at home.	
270	7SBT545PMM	Not a reader.	
271	J42P5854WQ	I like to buy my books.	
272	78AE8KNQH2	It's under renovation.	
273	4M38RHG62Q	Due to covid and I get what I want from my computer.	
275	88U48N2668	I have particular interests and my own library and what I can access on the internet is superior to the local library. I have used the Greymouth Library more but again not very much. I am used to access to university libraries so my needs are quite high.	
278	V56F7D2Q3D	I have a friend who has 10 books shelves of books.	
279	BRT5377RB2	I have lots of books at home.	
280	2437XK4KYJ	Covid.	
282	YC2R644387	We read the newspaper.	
283	FSK7TSGQT5	I use my kindle.	
284	P47N5FJRVX	I just read newspapers, I don't read books.	

286	387TWJ2M8U	Due to covid and I don't read much.	
287	K5JSH84Y3N	I am not a member and I don't have time. I get everything online.	
288	X8TPY5L4Q4	I read on my phone.	
289	CQB8C3BW84	Internet.	
290	8UXTAV88UK	I don't need it.	
291	5MK7TD7M47	I'm not a reader.	
294	JWBMH76AQ8	I do all my stuff online.	
296	L28C2QV6P4	I have been busy.	
297	KCU5S46U5E	No need.	
298	QB5E7J77DV	Don't read much.	
299	22538TJ3D8	I think the answer would be pretty common - too much television. I do read quite a bit but I haven't joined the library. I hope to. I hope to join, yes. I know a few people who are very satisfied with the library.	
300	4L5S6G66FV	You need a vaccine pass at the moment.	
301	688P4R4224	I buy my books and I don't have a lot of spare time to read.	
302	763D7YL82Y	I just haven't been reading. I found Neon.	
304	4E8KDC67TQ	Don't have time and live too far away.	
305	TK5V44Q57X	I don't read.	
309	QLS573GN28	I don't, not a reader.	
310	6BQ3VTVMNU	I'm not a book girl.	
311	37F8SHB673	I used to go, but not recently.	
312	G55LA65TF3	Not a member.	
315	7D3VG8X728	I am too busy.	
317	6E2588HW8X	Not interested.	
318	H6NLEH4DGV	I read online.	
319	47H7M86N3Y	No reason, I buy books.	
320	BC26P2B2Y2	I've never been to the library.	
321	T3Y8W7A4B7	I've read all the books that interest me.	
322	R5PYBLW726	I don't have time.	
324	332RC574B4	Don't read.	
326	7WN6EF6QR6	No reason.	
328	BEE36R68LK	Too far away and I use a kindle.	
331	RR6V368W5C	It's too far away and don't have a local library.	

332	EKXH8Q48D3	It is 200 km away.	
333	8Q2HQW3NU7	No call to visit the library recently.	
334	EFH878538N	I usually get my books online.	
335	546WDMFKVS	I don't need to. I can get access to whatever I want without having to go to a library.	
336	282L73HFGF	My card expired and I haven't been back.	
337	V658BR7F23	I'm not in Hokitika much.	
339	HG7T57JP7N	I don't use the library.	
341	76YESW52T7	I read online.	
342	6W7D633T4E	I don't use it now.	
343	H6568442JC	I buy books.	
344	264YR7VM6W	I have been busy enough without having to go to the library. I have books that I have had for five years and I still haven't read them I am too busy.	
346	A62R6KJA5T	I can't read. I am going blind.	
348	WQ5ENR277V	I go occasionally but not in the last year and mostly online now.	
349	77YE28M733	I use the internet.	
350	2RB5EH467J	I don't read. I've got too much to do to read.	
353	WPBTLAH42C	My kids have plenty of books.	
356	J2WDW8LUR2	I'm not a big reader.	
359	4HE3TK7VYL	I haven't needed to use it. No use for it. I don't mean that unfairly, I know there is a lot of people that do use it, I just don't.	
360	TS8NPE3462	No reason.	
365	7CAPDJ8M83	Now I have retired I am probably more busy than I have ever been in my life. We have a little farmlet.	
69	4JAS5KYASF	No need, think it is a defunct service to be honest in this age with the internet and mobile services.	
111	MJG8F4JV43	E-books.	
112	55SPBL7SP5	Prefer to buy own books.	
118	7V8E3W6MS4	Have a good stock of books at home.	
119	T22KRQELN5	Covid.	

ID	RC	Q16. Could you please tell me why you feel this way? - Hokitika pool	
8	GVX74254L7	Reasonably well maintained and value for money.	
9	7LR78WY7B5	Could be cleaner water wise. An updated changing room would be great.	
10	FDB8882NT5	Dated, not deep enough, old school needs modernizing.	Index
18	HF23E8B8GJ	It's a good environment. Not as busy as the Greymouth pool.	
19	57Q7744356	Expected work to be undertaken not even begun because of roof - it begs belief that assets are not maintained correctly.	
32	6D48LD2S7S	In the summer use the pool twice a week, very affordable, feels safe to use, worry that few people use it these days.	
38	64VAT555WP	I haven't used the pool since it reopened after refurbishment, however, I now can't use the pool with my two small children as they are vaccine passport only and I do not have a passport, however, I have visited other areas in the country in recent months and many of their Councils are not segregating, therefore we've been swimming at other pools, so I'm unsure why the Council has chosen to discriminate here. I'd like to know the rationale for this decision and who it was made by.	
41	5384P8T83W	The pool was cold and there was no separate area for young children (the small pool available is only suitable for toddlers). The changing rooms are old and dated, there's only one family changing room that has no shower. It's hard for families with little children as there isn't a changing area where they are secure while everyone is changing.	
43	BW23G6Y52S	Not very clean facilities and the pool is freezing. Far too cold.	
48	8VN8L8D53M	It looks exactly the same as before, but was closed for months in 2021. How much did the "upgrade" cost us in the end exactly? The pools look like they are straight out of 1980's NZ. If Hokitika pools are Westland's flagship pools, they leave a lot to be desired.	
57	VB8445N866	Ask yourselves, is it what the children really want? Would like to be proud of and tell others about. Get a kids pool forum going. Get funding, be creative, the pool is part of the town gateway.	

66	PMA6Q5Q7XW	As far as swimming goes, it's good. New upgrade has been good, although disappointed there hasn't been more thought to the toddler's pool. Swimming lesson prices went up. There's no choice of teacher and can be hard to find a time that works with only one working there. The price of a full season pass is unattainable. If Council considered a price drop, there might be more people able to come.	
77	VL6D76V6X3	Plenty of creeks and rivers around.	
81	2K85SG7R67	Was disappointed to pool shut down through swim club season. This could have been worked around.	
92	J7WD6524G2	More than one lifeguard needs to be on duty.	
94	X4AEJK448L	More lifeguards need to be on duty. One young lad won't save many people!	
96	435XJ8MA3Q	This season, the pool opens very late. Once it did, it was ok.	
99	ETL3AD4E5J	Good pool facility. Good to see it is getting an upgrade.	
101	B77M46MPX2	Too shallow. Changing rooms run down.	
106	A8B83P8VS8	It is adequate for the Hokitika community.	
107	MVHGWMD7CM	The upgrade is not nearly good enough. There needs to be a total overhaul of the changing rooms etc. than can accommodate everyone's needs, especially disabled.	
108	4PA5GW2H54	My children love the pool. The pool is the right temperature on our visits there.	
128	7BTPY766AV	Still doing it up, so will be a better rating when it is finished.	
134	SK7L58GX5M	Sometimes I think it's a bit chilly.	
136	PM83823Q2B	The changing cubicles are good. It seemed warmer and not so full of chemicals.	
144	8W7D635E82	I use it most days. We are lucky to have it.	
166	3347N64L6D	Sometimes it's not the cleanest. Hope this is sorted with the update.	
182	53FS6EY87H	I like the pools, I haven't seen it since it's been done up.	
184	NS33G7VHR6	There is no aqua sessions and there is an awful lot of elderly people that use it to stay fit. It is very disappointing that they haven't come up with a teacher for them.	

187	CJ35UW35XL	I go to the pool for medical reasons. Before the last lockdown, the lady who runs the pool was unbelievable - she facilitated a lot. She was amazing. The pool is a huge asset to the town. When this lady left, we celebrated her and the Council gave her a send off. She was cool. She should have had an article published in the Newspaper.	
191	27N784YF72	The swimming instructor should be paid to do the admin for the lessons. They have removed the glass door from the eastern end of the pool and now natural light as well as an emergency exit has been lost. My son likes going to Greymouth pool as he can enjoy more activities in the pool like manus off the side of the pool. The inflatables can only be at the deep end of the pool, so for a kid's birthday party they can't enjoy them.	
194	M2W4876DV2	It's a small town pool so you can't expect too much.	
206	YB27FDA73N	Not great. The pool is too shallow and not the right size. For swim meets, we have to travel.	
211	2635ES2B37	The bottom of the pool is rough and it's taking the skin off our feet. I don't know why? This is after it's been done up. My son has a season pass.	
237	34R44PR7BC	They get taken over by the swimming club so you can't use any of the lanes. It is like it is their pool and not the locals. They can't have the club taking over all the time.	
242	N86ER5Q8N6	The pools are fine and the people are excellent.	
252	X8KEV73H64	They are not open much.	
256	3678C7S5DJ	The one at Greymouth is a thousand times better. I take my grand-daughter to them.	
262	87M8D3Y3XA	It's clean, it's warm but could be warmer.	
265	4JKD4LBAG5	I love it, I would swim every day if I had time. I was very sad when the pool shut because I got too fat. I am pleased they have left it at the 33 metre size.	
270	7SBT545PMM	The quality of the pool and facilities were adequate and didn't require an upgrade. If they were going to spend over 3 million, they should have built a new pool at a better location. The present location doesn't have enough parking as is right at the edge of town.	

276	W8AQ5R67Y2	The facility, the ladies room and the dressing rooms were pretty old and it was very dark but I know it is all getting done but I haven't been since they re-opened it. They haven't got the staff to run the Aquasize programme which a lot of people went to. Up to 30 people at times. It was good for people's health. If they can't get the staff they shouldn't have got rid of the ones they had.	
281	PENY3T2G66	It is always clean, the staff are approachable and my grandkids just love it, because it is not overcrowded.	
293	L5NNC43B46	It just needs a really good scrub.	
306	DDV2HT7C22	Great service and a good facility.	
315	7D3VG8X728	They have done a good job with the upgrade.	
317	6E2588HW8X	Not enough activities for the kids in the pool.	
324	332RC574B4	They do the best with what they have.	
325	W8AGL24Q65	I find it really loud. Could you improve the acoustics?.	
329	22XLP75L26	I just find it frustrating with the amount of times it is closed. It has got me out of the habit of swimming and I am going to the gym instead.	
334	EFH878538N	I couldn't go in water when I went there and I had to go there for exercise and they were very helpful and got me up to my shoulders in the water and got me over my fear of water.	
341	76YESW52T7	It's just been tidied up and is clean and the opening hours are good.	
343	H6568442JC	They need longer hours, otherwise that would be a 10.	
349	77YE28M733	The pools have changed and I don't I don't think it's so good now. I think it's a bit unsettled for the staff and people who use the pool. (Not a great atmosphere).	
354	L2J538668W	They do the best they can with the resources they are provided with. They are always willing to help you. They keep it very clean and the lifeguards are good. My children do lessons there and the instructors are awesome but the one thing the council could do to make it easier is provide more swimming instructors.	
358	32SVGKB8P7	The pool was closed over a prime period of the swimming season. They should have upgraded in the winter. The staff are good.	
363	82CWA4CV25	I haven't been there since the shutdown but to me, it has been fine.	

110	3757SPASR8	Staff are friendly and welcoming, great facility for the community, always clean & well maintained.	
113	3GTK5ESA84	The temperature is the biggest issue - too cold for babies/children for more than 20 minutes. No baby swim class, changing facilities are poor. Shower is good. No proper toddler pool, way too old. No proper family changing rooms.	
114	NQKM2PKP8M	It's good when it's open. Been closed for a while.	
116	JXBBW63T4W	My money and my health were good enough to enter the pool! At Level 2! Being banned at Red Traffic light was and still is appalling. Council and Gov't. are too heavy handed with people who are not vaccinated yet fit and well. I pay for this service in my rates yet am treated like a lepper. Appalling. Why has the swim teacher felt bullied by Council? Shame! Why did good quality pool staff leave to be replaced by inexperienced staff? Shame!	

ID	RC	Q19. Could you please tell me why you feel this way? - Standard and safety of unsealed roads	 Index
1	2XRMG654MU	The Kawhaka road is fine, in fact excellent, until the last few kilometres which are unfinished. That section is a disgrace.	
3	3H82BQQKQ4	Roads have potholes and sides of roads have long grass.	
4	U2224FFPK8	Water wash outs as a result of very poor maintenance by Westroads - all drains need clean outs which would mean less washouts would happen. All drains on Hokitika town are full of silt/rubbish/weeds which prevent drainage when significant rains happen.	
5	LW76DQBE76	The sealed ones aren't much chop either.	
6	8RPPR24Y7T	It was very bumpy but I understand that the grader was out of action at the time.	
7	P666QY85R2	Lots of corrugations.	
8	GVX74254L7	Reasonably well maintained given no tourists.	
9	7LR78WY7B5	They're good.	
10	FDB8882NT5	Adairs Road, please grade it.	
11	MTCU476NKE	They are not well maintained at all.	
12	K6P56EEH6H	Not graded enough.	
13	H4RR2WK3J4	Potholes!!!! As no-one(tourists) are not visiting the area, the roads in general have been neglected, failing to remember about the locals that use it.	
14	54GBDSTCK2	Very little maintenance with terrible potholes from the milk tankers, very hard on new cars.	
15	NQJ27533B4	Unsealed roads are pretty well maintained, very narrow though, especially around Dorothy Falls Road.	

18	HF23E8B8GJ	The road up Gillams Gully is always in poor condition. The stones put on it have not made it any better and its camber is always off. The speed restriction wouldn't have been necessary if the Council had invested in the road itself rather than a band aid fix. The section of just over 1km needs to be sealed. It seems ridiculous that the Council spent all that money on old Christchurch Road, past where any dwellings (and rate payers live!) Yet Gillam's Gully still has this section of gravel. Considering we provide our own water and wastewater treatment in this area, the Council should at least provide decent roading infrastructure.	
19	57Q7744356	Grading works not carried out with enough knowledge of roads, how water sits on particular roads.	
21	VNUSJ4AV65	Generally good but a few "expected" potholes being a gravel road.	
22	6W5B6W3TVB	It's a gravel road so bit bumpy.	
23	6PW48NAX62	Better maintenance required.	
26	6YAR5TG72H	Filling potholes more often or on a regular basis would improve driving experience immensely.	
27	PTBF52JTX5	Not maintained to a satisfactory standard.	
28	825AVGB5PR	Adairs Road has very little maintenance and corrugated by gold miners use. Milltown Rd has been shared by Westroads trucks for a considerable time and can be dangerous with speeds and clearance. As a cyclist, I have had a couple of close calls. Section from Pyramid Hill to Arahura River has minimal maintenance and gets rutted. Lake Kaniere Rd to Styx River has grader over it from time to time but no other improvements to surface and rutting.	
33	TH2WQ55K88	Lack of grader driver.	
34	2383T8RB3Q	I live along an unsealed road. Maintenance is sporadic but I'm happy that at least the road is maintained.	
35	LBBVEH73DC	Over whitebait season, a lot of roads in South Westland get rutted, more potholes and aren't in good condition. The standards really drop and it seems like maintaining is of low priority to the Council.	
36	65C628644P	The road was adequately maintained for the area.	
37	X6332J56L5	Pot holes on Bold Head road.	
39	35C2553333	They are great.	

40	54M86G63X3	I grew up with unsealed roads - ours are fine - a bit challenged with our big rain events - but certainly better than I remember NZ unsealed roads 50 years ago. I think the majority of the unsealed roads I have been on recently are adequate to good. The ones that are adequate would be rarely used. A few (like Adairs) that are regularly used should be sealed.	
41	5384P8T83W	It's what you'd expect from an unsealed road. Pot holes and a narrow road.	
42	5DUN8473FX	The unsealed roads are in good condition as far as potholes and grading is concerned but they are VERY narrow. If tourism picks up again I can see multiple accidents happening because of road width.	
43	BW23G6Y52S	Why does council insist on scattering gravel on roads and then leaving it for cars and motorcycles to swerve on. Lots of pot holes on way to Gorge have been left unfixed yet have been circled by repair personnel for a future fix - some have been like this over 6 months.	
45	R7658647RH	They are generally graded well.	
46	36P84B53VW	Adairs Road surface is terrible. Island Road always full of potholes, you could be lost in. Kaniere tram from Pinetree Road west until no exit surface okay, but now much more new housing, needs sealing.	
47	Q5AWMQ5625	The amount of time before potholes are filled in, the lack of flanking of roads to let water away, as this causes potholes too for Water table maintenance (lack of drain maintenance - time intervals).	
48	8VN8L8D53M	Depends where you go but some are in pretty good nick, others are riddled with potholes.	
49	3666654NN5	Lots of potholes on the road I used.	
50	75UK66R6MG	The Westland area has very little gravel roads in our Council area for the size of it and I find the roads to always be well graded and not too many pot holes. Due to previous Councils having the foresight to push for tar sealed roads, we are very lucky to have a great network of roads and I drive on gravel roads at least once or twice a week.	
51	64W5L87428	Road was only half sealed then very large stones unsealed road joining without warning.	

53	P3SWVQTWUU	I'm sure they are very good roads, but I always feel mildly unsafe and like I'm going to drop off the edge whenever I'm on any unsealed road, so it's probably more of a reflection on my perception than what the road is actually like.	
54	CTCL5YBCBT	Mostly they are adequately maintained.	
55	USRMSM38VW	The road I use regularly is well maintained, but I'd rather see it sealed.	
56	36G43R3455	They are not maintained up to standard.	
57	VB8445N866	Great for what they are. I imagine maintaining is an ongoing battle.	
59	E87LH5NUE2	Pot holes take long time to fix.	
60	QTY2JPPT76	Mikonui Road is not maintained to a safe level.	
61	Q336266YNQ	Not graded enough, a lot of corrugation and over grown grass verge.	
63	23A22P6JC4	Hau Hau Road surface gets quite rutted. There is far too much fly tipping along these roads and more active policing fines need to be applied to those that do.	
64	S2Y7GY6GC2	Unsealed roads are never perfect, although I feel the Council has wasted dollars sealing roads that don't need sealing, e.g. Kawaka Old Christchurch Road, as it is a narrow winding road with very few houses on it and sealing it encourages drivers to go faster on it, increasing chances of an accident.	
66	PMA6Q5Q7XW	Fine. I don't know. It's a gravel road. Part of the coast.	
67	WS6CSX32Q4	Would love for Adairs Road to be sealed! The dust from it layers my house. After heavy rain needs maintenance.	
68	R3X24YR7Q2	Potholes and corrugations.	
70	J2W528644C	Potholes.	
71	U FK8ACBNBG	Some potholes.	
74	B5JNC2UM87	Lots of corrugation. Pretty rough to drive on. Need to be maintained regularly.	
75	3YJ7F6MVSF	The roads are graded a couple of times each year, all that one should expect.	
76	8S22F78CX3	Very variable.	
77	VL6D76V6X3	Because dirt roads are dirt roads, and you should drive accordingly.	
82	R52SAB6L4H	Lake Kaniere Road, in good condition, impressed with all the work that has been done.	
84	QV2YS76L5H	Potholes and rivets.	

85	T22BQ7D3N8	Rough roads.	
86	4275JK5777	They appear to be maintained/graded.	
87	8824AJTSDK	Adairs Road, we use three to four times a year. Sunday drive.	
88	876F2CB5K7	Potholes.	
89	RPXQ77BDP7	Pretty rough!	
90	AHL3R2QFJ6	Potholes seem to be filled promptly, thank you.	
91	F58EP6T55W	Not maintained.	
92	J7WD6524G2	Needs maintenance.	
93	H5CRN8B7GM	Seems to take a while for some to get potholes filled.	
94	X4AEJK448L	Potholes!	
95	U3D5DBC48M	Gravel roads - you have to keep speed low for surfaces and loose gravel on sides.	
97	HG6F35S4X5	In constant road edge marking unsafe at night.	
99	ETL3AD4E5J	Sign posted seemed to take a long time to seal it.	
100	8F5658N RTP	Not too many potholes.	
101	B77M46MPX2	Unsealed roads generally pretty good, but let's get them sealed.	
102	6T5FUTUW6A	Most important roads are sealed. I drive a Landcruiser.	
103	JH3MK5S3P2	Six kilometres of the Old Christchurch Road is still unsealed. Money could have been used here rather than other wasted projects.	
104	66867BWNWM	Needs to be graded & checked after rain.	
105	45E734TNM3	Some unsealed roads good, some poor.	
106	A8B83P8VS8	Average maintenance overall.	
107	MVHGWMD7CM	I have found the unsealed roads that I have driven on to be a good experience - well maintained.	
124	LQ7G3766CV	Unmaintained. Lack of maintenance.	
125	U7BU3K4CB5	It's not the road, its the driver and the speed. A lot of businesses and farms use these roads, the roads do get looked after because they need to be.	
126	6274MWB7N2	Up keep, pot holes, need more maintenance.	
127	7RLRWB7TC4	Seaview Road is appalling, potholes, poor maintenance.	
128	7BTPY766AV	Dangerous. It's used by lots of people, windy and not a two way road.	
129	5SG6RK6A7V	Gravel road, reasonable generally. Depends on the weather, but pretty well maintained.	

130	3QJ5765K85	Generally satisfied. Lower rating is on hearsay, some of these comments aren't good.	
131	VB7BP2867S	The roads don't get looked after. The roads have never been the same since the 2019 floods. The guys that got the road usable were great but they aren't graded enough, like maybe every six months. We get regular punctures with the rough road.	
135	52A4K3X883	Lots of potholes.	
139	2EH4T6A26C	It would be good if they were sealed.	
140	WV2J8J2HSV	Road by Lagoon and beach, from pothole to pothole - they are very big. They did some work but it's not right. John Olsen Road, horrendous potholes, recently fixed.	
141	57HB4847V2	Full of pot holes, not well maintained. Not well marked. Terrible for driving at night. Side markers would be a good start.	
142	GV456A27S2	The roads are not maintained well enough, pot holes and scrubbed too close to the edge of the road.	
143	6C4857423N	At times I see potholes.	
144	8W7D635E82	They are not too badly corrugated.	
145	X62662QKQK	The gravel road was in good condition.	
146	662BB7TCJ3	There are a few corrugations and pot holes.	
148	6R6KE5AGH7	Pretty average, just on the better side of bad.	
149	BJ4326F584	The maintenance is not quite there. A few potholes.	
150	UGL6JFM7Y7	Peterson Road, Hari Hari is not well kept in the Northern End. They only do it once a year and never fill in the potholes.	
151	W2UKV68JRB	Not sealed, pot holes, needs more regular grading.	
152	Y6C8838W77	Unless it has just been recently graded, the roads will be rough.	
153	5EH446CCX7	They roads are disgusting, pot holes, rocks and dust, not good.	
154	5J7V6568U3	I think maintenance standards have slipped in the last 3 years.	
155	FVC3Y4G33S	It would be better if it was tar seal.	
156	B2H2YR82YW	They are just ok.	
157	U6G75T53UA	Very narrow, windy and gravelly. They are okay.	
158	DE6N88483X	They were a bit rough with pot holes - these were near the gold mines.	

159	Y4T6SXN55X	They are not graded properly, they are constantly full of potholes. Their effort at repairing potholes, if lucky lasts 24 hours. They need to do proper repair jobs. They don't even grade them regularly enough. The ditches are not maintained either, and it's hard to see where the ditches are. Even the rubbish truck fell in the ditch.	
160	E82R52F8L7	No problem to us, well cared for.	
161	P8H6A5Q4LM	Not well maintained. Potholes, need to be graded and gravelled more, they are rough.	
162	X2ERX738UV	Ungraded, very corrugated, unkept. Usually the berms are very untidy and never mowed.	
163	2Q52T82HDR	They are fine the gravel roads.	
164	8X3E5NT22Y	Corrugations, pot holes, and generally not kept nicely looked after.	
165	4XH8LS6SPB	The roads have a few potholes.	
166	3347N64L6D	So many potholes and ruts in the roads it's ridiculous.	
167	6SX7EY86P7	There is a lack of decent speed limits. They are either dusty or muddy.	
169	2V6XP654K7	A few pot holes, but okay to drive on.	
171	J4KY6P3YKD	The roads are potholed and with the rain, very corrugated. The road has not been maintained.	
172	CDJA4B5583	They are okay. It's hard to maintain unsealed roads.	
174	AWW62AQ34M	They are not maintained. Potholes, corrugations overflowing drains.	
175	K534CT2H2B	Typical of unsealed roads, some are not very wide and have a lot of bends in them.	
176	P286JRDW4W	Always challenges with potholes. They are generally okay.	
177	4SQBVG847R	Pretty good nick.	
178	8B2HAF777F	The surface is not good. Hard to negotiate and damages the cars. We get lots of potholes.	
180	HLQ3E5E83V	They are full of potholes.	
181	WH84K66K5T	The roads are quite passable but could do with improvement.	
182	53FS6EY87H	Some are pretty narrow and some need potholes fixed.	
183	2QQ6HFW3FB	They seemed really good.	
185	K483R3C875	They are unsealed roads and we get a lot of rain so they do wash out. It is not the Council's fault that they wear out because of the climate.	

187	CJ35UW35XL	Near Lake Kaniere the road is really bad going around through Kokatahi. This road is dangerous. This road needs to be maintained.	
188	L2D2PH22VE	Good condition.	
189	73EM4RJVB3	I don't think they are terribly safe - unsealed roads anywhere.	
190	S8JCE8N2L4	It is a gravel road. It is never going to be perfect, it is not really the Council's fault so much.	
191	27N784YF72	It is usually well maintained but during winter there are potholes.	
192	UJAREF753S	The roads were good until after the flood.	
193	67R33EN3J2	They are average and corrugated and full of potholes.	
194	M2W4876DV2	Our road was supposed to be sealed 2 years ago, we are still waiting. Cement Lead Road.	
195	DT28MAD2M8	It has potholes and is very dusty.	
197	PAU87M336U	They have remained a gravel road for too long. They need to be tarred. Some of the roads are dangerous and need better signage for e.g. the Hauhau Road.	
198	5N242MY7M3	The Goldsbrough to Stafford Road could do with more gravel and is quite potholey and needs a bit more care at times.	
199	858455DF8Q	Very rough and not well maintained.	
200	PKL6V82LAQ	There are potholes which are dangerous for small cars. My boss brought me a bigger car due to the roads. How do the elderly manage on the roads. There is no phone coverage if you break down.	
202	TU68W437D4	There are lots of potholes as there is a lot of rain. It's pretty rough at times.	
203	43GWDN347K	The unsealed roads are pot-hole, the grader hadn't been through for a while. Adairs Road is shocking.	
204	L2N2APH5X4	Most of the time they are fairly accessible.	
205	E25NH74J35	They are okay as unsealed roads mainly if it stays fine.	
206	YB27FDA73N	For 15 years we were promised our road would be sealed, it still hasn't been done. Cement Lead Road. It is terrible and there are so many houses up there. It's only 1km to seal.	
207	3HJCND837D	It is so rough. The top layer is so rough.	
208	R26622CD56	The roads are full of pot holes.	
209	G784D2BM76	The grading of the gravel is not good. The roads are dangerous.	

210	UJGEY57452	Full of potholes and when they grade them all the shingle is in the middle and you don't want to meet a milk tanker on any of them. The number of marker pegs are very low.	
211	2635ES2B37	The roads are horrible and dangerous.	
212	BNSVGV5H2	Too many potholes.	
214	5JT884783L	Roads had a lot of potholes.	
215	6Q6KD7CS2Y	I think that the general maintenance is poor for roads and footpaths.	
216	7EPNE68RL3	My son crashed my car and it was a write off.	
217	SF7VK83VLX	They are usually well maintained.	
219	PX4U2527J7	They have been maintained and they keep the potholes out of them. People go over them far too fast and a lower speed would be good if anyone is walking along the road.	
220	JWG88HH5R6	The roads are extremely poorly maintained, shocking, dangerous. Potholes, washouts, the verges aren't mowed, visibility is low. You can't pull off to the sides. Any maintenance is shoddy at best.	
221	P22B484432	Council needs to service the gravel roads more often. They leave it too long and the potholes get too big.	
222	J3J5245PKG	A few potholes that could be filled in more often. They are not perfect but okay.	
223	44C4274N37	The roads I have been on have been fine.	
225	R4866LMG46	The road had been just graded.	
226	2448LYU6C4	They roads are narrow and quite dangerous, such as oncoming traffic with no room to pass. It keeps the roads quiet.	
228	Y8VS5DP4QX	I travel only 200-300 meters on a gravel road and have no problem.	
231	MA3M5V5G6K	In general the roads seem to be in good condition but they seem to prefer to reduce the speed limit instead of fixing the road. The roads need more frequent grading.	
232	W2846MBGT6	They are pretty rough with potholes.	
235	K3E36JQ554	Some of the roads have potholes and do not get enough attention. The operators need better training and experience to do the grading on the roads. They need to have a better "care factor".	

236	FLQ7SE3Q7W	My biggest complaint, the road is 30km with 20km of gravel. We have lots of accidents here. Old Christchurch Road. The road is terrible. We had 8 accidents in 6.5 months at one stage. They were really bad accidents. The road is safer, but not all of it is done. I think they must have run out of money when it came to doing it up.	
237	34R44PR7BC	Some of the roads are a bit on the dodgy side but they get to them when they can as we do have extreme weather.	
238	535236444W	They are okay.	
239	C6XTP2S2VT	Not happy that the road is still a gravel road.	
241	6JTWG57DQ7	They have good signage and indicating sharp corners.	
242	N86ER5Q8N6	They are okay, you can only have what you can afford.	
243	Y7E4F7GX3V	The roads are rubbish. They are not maintained, they are pathetic. They don't fill potholes.	
244	F43TESSLWC	The roads are seldom graded and never totally repaired. Wash outs are not fixed. One of the roads I can't take my car along.	
245	B7MCC3GU75	They are pretty corrugated.	
248	8D6PWJ342N	The grading does not go very regularly.	
251	32J3D3NDE7	There are potholes and corrugations.	
252	X8KEV73H64	There are pot holes.	
253	K3VH48J5G5	The staff need better training on repairing the roads. For e.g. where the Marae is on the left hand side, water runs down the side of the road. They have repaired it multiple times but nothing has happened. They are fixing the problem but not the cause.	
254	5H7T368E7Q	The Gorge, there was a huge pothole on one corner. If you didn't notice it your would do some big damage to your car.	
257	F5TAMAFTFM	Adairs Road is terrible - corrugated. They have just graded it and it is like driving in chalk. Before that, it would shake your car to pieces.	
258	57BVPQ3LG5	Some of them are alright but some of them are a little bit forgotten about. I use them quite a lot and they need to be taken more notice of. If you are up there with trailers and wood and so forth it can be dangerous. Potholes and crumbling edges when you need to turn around, they need a little bit more maintenance.	

260	8W243TKGVU	They don't grade it like they used to so the camber is all wrong and there are potholes.	
261	PU7K2T856P	They are dusty and potholey, plenty of people going crook about them.	
263	4L27755LQV	They are fine. Reasonably well maintained. They are driveable, with no major potholes.	
264	6825K3434Q	They are not grading the gravel roads often enough.	
265	4JKD4LBAG5	They are adequate they are what you would expect from a rural road. They do maintain them.	
266	B8PAL2GC2E	It would be nice to see a road that starts sealed to be entirely sealed not half and half for e.g. old Christchurch Road or Arahura Road.	
267	4AAETXCE52	I don't remember the state of the road.	
268	K3753624GS	I try and stay off them unless it is absolutely necessary.	
270	7SBT545PMM	The roads are satisfactory but due to the heavy rainfall the roads need more maintenance.	
271	J42P5854WQ	The pot holes on the tar sealed roads are worse than on the gravel roads.	
274	UG7P765663	They have a few potholes and stuff in it. It is maintained but it could have better maintenance.	
275	88U48N2668	I don't have high expectations in a small rural area there is a limit to how much we spend on grading our roads. If we spend money on grading roads it is money that could be spent elsewhere.	
277	Y73Q3CU7W6	They got some money from the provincial gross fund and they were given 3.5 million dollars to tar seal the Old Christchurch road. They ran out of money and didn't finish the last 2 kms. Somewhere along the line somebody made a blue.	
280	2437XK4KYJ	Could do with more maintenance.	
281	PENY3T2G66	The dust in the summer. The maintenance is fine but the dust is horrific.	
282	YC2R644387	I had to clean my car when I came home as the road was very dusty.	
283	FSK7TSGQT5	The road was rough, but then there has been bad weather. The road got washed out last year and it's still not right.	
284	P47N5FJRVX	You can't do everything you only have a certain amount of money to do certain things.	
285	7Q7LA43835	They are too rough.	
287	K5JSH84Y3N	Some need a bit of work.	

288	X8TPY5L4Q4	It was fine to drive on.	
289	CQB8C3BW84	The Stafford Loop Road has a bit at Goldsborough where there is some toilet facilities, there is a two-kilometre section that needed sealing and has done for years. I feel for the amount of people using it should be sealed.	
290	8UXTAV88UK	There is a lot more traffic. They need more regular grading.	
291	5MK7TD7M47	They are reasonable, not too bad.	
292	7S55GJ58HV	No.	
294	JWBMH76AQ8	Bumpy and dusty.	
295	3VV67QH5QG	They are full of potholes.	
296	L28C2QV6P4	They are graded but not very well. Still lots of corrugations.	
298	QB5E7J77DV	N/a.	
299	22538TJ3D8	I have seen them filling the potholes so they must maintain it. Adairs Road.	
300	4L5S6G66FV	The roads have a lack of maintenance.	
301	688P4R4224	It was satisfactory but it is a bit rough - Adairs Rd.	
302	763D7YL82Y	It was pretty good - again they can be maintained better but I thought it was adequate.	
303	3NQ5V6US48	They could do with improvement, big pot holes.	
304	4E8KDC67TQ	They are okay, they do the job.	
305	TK5V44Q57X	I thought they were pretty.	
306	DDV2HT7C22	Adairs Road is very corrugated and the Old Christchurch road is pretty rough and unfinished.	
312	G55LA65TF3	They are what they are!	
314	343E225W2S	There isn't enough maintenance being done. I object to running over potholes.	
315	7D3VG8X728	They could do more maintenance. Some roads are dangerous.	
317	6E2588HW8X	They are full of pot holes.	
318	H6NLEH4DGV	They are terrible. The pot holes are terrible.	
319	47H7M86N3Y	Lots of potholes and stones flicking up when you drive.	
320	BC26P2B2Y2	They have potholes on bad days and not on good days.	
321	T3Y8W7A4B7	They are pretty well maintained. Better than a lot of other rural roads throughout the country, and I have travelled a lot.	

322	R5PYBLW726	Adairs Road has a lot of potholes and corrugations.	
324	332RC574B4	They are what they are.	
325	W8AGL24Q65	There are a few corrugations and potholes.	
326	7WN6EF6QR6	They aren't too bad, just a bit rough.	
327	55V334QH5E	It seems to be gravelled well, there are no big stones and no potholes.	
329	22XLP75L26	East Road, I am unsure of how safe it is and what standard makes it safe.	
330	RXGE7NGN6F	I daresay when you go off the gravel onto the tar seal you think it would be nice if it was sealed.	
332	EKXH8Q48D3	Because they have put some contractors on who do not understand how Westcoast water runs and put some drainage in that made it worse. Mulvaney Road.	
333	8Q2HQW3NU7	The upkeep is bloody poor. The surfaces have potholes and corrugations.	
335	546WDMFKVS	I try and stay off them unless it is absolutely necessary.	
336	282L73HFGF	They should be sealed.	
337	V658BR7F23	Not too good, shocking - Whanganui Flat Road.	
338	M53YV7APJK	They are not doing a bad job these days.	
339	HG7T57JP7N	There are potholes and could be better.	
341	76YESW52T7	Some are quite rutted.	
343	H6568442JC	They are alright.	
344	264YR7VM6W	Adairs Road was full of potholes but within a few days, the Council was there filling in the potholes.	
345	7EV5S734X5	Potholes, not graded correctly, gorse overhanging the road.	
346	A62R6KJA5T	The only thing they don't do is make them wide enough. When you grade the road. It's all money now, they just do a quick bit. I used to work for the council and it used to be quality not quantity and now it is the other way round.	
347	36XK3J4467	They are corrugated and quite rough and sometimes the general maintenance isn't that great.	
348	WQ5ENR277V	There are always potholes, they are never going to be perfect.	
349	77YE28M733	The speed limits are unclear. There are potholes which damage your vehicle.	
350	2RB5EH467J	It all depends on the weather, if the weather is good they are fine but if we get a storm they are liable to be washed out.	

351	P338684522	I think they are okay and well maintained for the conditions in the area.	
352	4X36NBL46B	Most of the unsealed roads I have driven on are really good but there is one close to where I live that is not maintained regularly and potholes do appear - McArthur Road.	
353	WPBTLAH42C	I live near a quarry and the road deteriorates all the time. With the rain and the trucks, this road is always a mess. They try with grading, but not very often.	
355	GN3AG8WR23	They roads quite often wash out at Lake Canary.	
357	6KG4BGW5B8	They are not always graded like they should be and there are lots of potholes in the ones that aren't looked after properly.	
359	4HE3TK7VYL	All gravel roads can be improved.	
361	5MK2M5TDNU	It should be sealed - Gillams Gully Road. There are more houses down there now.	
362	325NDUN472	There are bits which aren't good and in need of attention.	
363	82CWA4CV25	I live on a gravel road. It's not too bad, they regularly fill the potholes.	
364	256AG8Y5H6	It needs to be sealed. Old Christchurch Road.	
365	7CAPDJ8M83	Harihari Road has a lot of uphill corrugations.	
69	4JAS5KYASF	Poor state of repair.	
110	3757SPASR8	Some weed spraying needed. Often many potholes.	
111	MJG8F4JV43	Graded regularly and better than some of their sealed roads.	
112	55SPBL7SP5	Bit disappointed the roads are not sealed.	
113	3GTK5ESA84	Through Goldsborough Road is corrugated and needs sealing. Through Kawaka (old Christchurch Road) is so narrow, two UTEs cannot pass each other.	
114	NQKM2PKP8M	They're okay. Old Christchurch Road was rough.	
116	JXBBW63T4W	In an ideal world, more roads should be sealed for a better or safer experience.	
117	35A5E3548G	More can be done to maintain the roads.	
118	7V8E3W6MS4	Generally the surfaces are good and not corrugated and most speed limits are sensible. Some could be lower where unsealed roads are narrower and winding.	
119	T22KRQELN5	Very rough, not graded enough.	
120	UP62Y7LN68	Mostly good. Occasionally takes a long time to repair after rain.	

121	778WAA26CB	Roads kept graded.	
-----	------------	--------------------	--

ID	RC	Q22. Could you please tell me why you feel this way? - Standard of the community halls	
1	2XRMG654MU	Fine by me.	Index
6	8RPPR24Y7T	The hall had a lot of borer in the woodwork. There was not a source of heating for the large hall area. It was a good price to rent and lots of room for our event. We would use it again.	
11	MTCU476NKE	The community groups are struggling for funding to update their facilities.	
13	H4RR2WK3J4	Average only visited for short time period. This was the Franz community hall for my kids as they play badminton.	
16	FS75M2K5T5	I feel the Hari Hari Community hall is unnecessary.	
22	6W5B6W3TVB	No.	
34	2383T8RB3Q	The hall I visit frequently is maintained by the community with very little apparent direct or indirect input from the Council.	
37	X6332J56L5	On the whole Ross hall excellent facility but some of the doors that go to the outside from the supper room are in need of replacing. Could be a potential risk in not opening in an emergency.	
41	5384P8T83W	Lazar Park hall - which is currently under construction. Great facility, will be great to see the finished hall once construction is complete.	
44	VH5435CYW4	Good standard.	
50	75UK66R6MG	Our local community halls in my area are in good tidy condition.(Kokatahi and Kowhitirangi Halls.	
52	YU2F24Q23F	Kumara Hall is old but well equipped.	
54	CTCL5YBCBT	They are fit for purpose.	
58	6FDJXE4GDP	I find that sometimes the floors aren't cleaned the best. Other than that they are great.	
60	QTY2JPPT76	Hall in Ross is always clean and inviting.	
61	Q336266YNQ	Cosy.	
64	S2Y7GY6GC2	Community Halls are all good we probably have more halls than necessary per head of population.	
65	7AECJ6CLPB	The Hall supplies outlets for people to join, exercise, etc.	
66	PMA6Q5Q7XW	Clean, tidy. Well looked after and easily accessible.	
78	3L37MQ3J26	They are clean, warm and hospitable.	

86	4275JK5777	Work left unfinished from provincial growth funds. For instance, weatherboards left off.	
90	AHL3R2QFJ6	The Kumara Memorial Hall is owned by the residents, not owned by Council and is a marvellous facility.	
95	U3D5DBC48M	Always well cleaned and tidy.	
100	8F5658NRTP	Well maintained.	
106	A8B83P8VS8	I have only used Reagent Theatre and I think it serves us well, thanks to the volunteer input.	
126	6274MWB7N2	It's had a lot of work and it's work in progress.	
127	7RLRWB7TC4	Maintenance is good, just been painted.	
132	VPV6WSQJ2E	Not high class, just average, they do the job.	
135	52A4K3X883	Well kept and tidy.	
138	RAYC44BCYK	A recent repaint has helped with the look.	
140	WV2J8J2HSV	Been maintained reasonably well.	
141	57HB4847V2	All the hall are pretty tired and need of an upgrade.	
142	GV456A27S2	The facilities have been reasonable.	
144	8W7D635E82	It was fine, fit for purpose.	
145	X62662QKQK	We have very nice events especially Anzac Day and Christmas carols.	
149	BJ4326F584	It been upgraded and is well maintained and it's a good facility that we need.	
150	UGL6JFM7Y7	Hari Hari Hall - it's new and purpose build and seems to have all the facilities.	
155	FVC3Y4G33S	The hall was alright.	
163	2Q52T82HDR	It's very tidy, they have done a good job on tidying it up.	
164	8X3E5NT22Y	Kumara Hall, everything is good and it's well used.	
168	Y866Q3LE68	It's good, we play cards down there. It has nice club rooms.	
169	2V6XP654K7	The Kokatahi Hall is great.	
173	YH7YFVDJR5	Too expensive to do anything at the hall for hiring. The maintenance is fine.	
175	K534CT2H2B	Because it is all adequate; a community hall done by the locals and it is pretty good for our area. It has the fire brigade, badminton and squash club, community hall and a meeting room an all in one facility.	
177	4SQBVG847R	They are well looked after at Ross.	

178	8B2HAF777F	The are not flash, just basic and adequate.	
182	53FS6EY87H	The Racecourse - that was good and tidy.	
183	2QQ6HFW3FB	The Lions Hall, I think will be pretty good just renovated.	
185	K483R3C875	It is an asset to the community.	
190	S8JCE8N2L4	Its alright, the community hall in Ross.	
192	UJAREF753S	Nice and clean and tidy.	
193	67R33EN3J2	The had upgraded the hall recently which was great.	
196	46C754P4NL	There has been improvements made and some improvements are planned. Greypower rooms.	
198	5N242MY7M3	I happen to be on the Kumara hall committee and we have a very energetic group and we are in limbo while some renovations are being done and council are assisting us very well with progress there.	
199	858455DF8Q	They are good, they do the job.	
202	TU68W437D4	Hari Hari hall, it's very new and fantastic, clean and tidy.	
203	43GWDN347K	The Hari Hari hall, it is new and clean.	
208	R26622CD56	Haast Hall is not flash, just okay.	
209	G784D2BM76	The Kokatahi Hall is great. The Ross hall is great too.	
210	UJGEY57452	The West Coast Development trust gave them a heap of money - Whataroa Community Hall. It has been upgraded, kitchen, toilets and fire doors and disabled access as well.	
215	6Q6KD7CS2Y	The building is fairly old but it has had a lot of work on it. I don't like the fact that the hall has virtually no windows. They are very high up and it makes the hall feel gloomy and cold.	
216	7EPNE68RL3	Its old and needs an upgrade.	
217	SF7VK83VLX	The community is funded to maintain the hall.	
222	J3J5245PKG	Hari Hari Hall, it's beautiful.	
234	2K5UUH3A38	It is maintained by volunteers in Ross, not the council.	
240	H45DR6Q7CL	The Grey Power hall is pretty neat.	
244	F43TESSLWC	Hari Hari hall is excellent.	
245	B7MCC3GU75	The Hari Hari Hall is well laid out. The only complaint is they are used as the public toilets.	
248	8D6PWJ342N	The Ross Hall is great.	

260	8W243TKGVU	Because I use the facilities often and I keep the place tidy for others and it is an awesome community facility - Kokatahi Hall.	
264	6825K3434Q	The local community puts money and effort towards it.	
268	K3753624GS	Some of them need upgrading and maintenance.	
274	UG7P765663	It is in good condition, a good kitchen and good lighting. Kokatahi hall.	
276	W8AQ5R67Y2	It has been done up but not to my satisfaction - not how I would have done it. It has terrible acoustics and it is not used enough because of that - you can't hear what people are saying it has such a high roof it bounces all over the place. More volunteers would help to get it used more.	
277	Y73Q3CU7W6	The halls are maintained by community groups like the RSA & Greypower.	
279	BRT5377RB2	The Ross Hall was good.	
284	P47N5FJRVX	It has just been all done up, it is the only thing we have got here. We haven't got a hotel so the hall is the main thing now for us here.	
291	5MK7TD7M47	The Ross Hall, it's good.	
292	7S55GJ58HV	The RSA hall is fairly new, clean and tidy.	
296	L28C2QV6P4	The Hari Hari hall. It would get a 10 but they are using it for public toilets. The wall cladding is not suitable for a wet area and they are too small for public toilets. You can barely turn around in them. The toilets in the hall are really nice. The ones for the public are not good.	
298	QB5E7J77DV	There is a lot of work going on in the Kumara town hall.	
299	22538TJ3D8	It is a school hall really but I presume it is a community hall and it is maintained quite well. St Mary's. I don't think there is a council hall in the district.	
302	763D7YL82Y	The community are looking after it and they are doing a good job - Kumara hall. I know it has issues but the standard is okay, it is usable. The foundations need work.	
305	TK5V44Q57X	The Hari Hari Hall is pretty nice.	
325	W8AGL24Q65	The Picture theatre? Great acoustics and good place with good safety and easily accessible.	
326	7WN6EF6QR6	The Hari Hari hall is great.	
331	RR6V368W5C	The Hari Hari hall is great, it's new.	

332	EKXH8Q48D3	Our local hall needs to be brought up to health and safety measures and they have the money, I don't know if it is council or our committee but it is taking some time. Bruce Bay Hall.	
333	8Q2HQW3NU7	Kumara and Ross Halls are in need of attention.	
337	V658BR7F23	She's brand new and top of the line, Hari Hari Hall.	
340	6R84Y8YQH7	The Anglican Hall is great. Not sure if the Council helps with maintenance.	
341	76YESW52T7	The Whataroa Hall is great.	
344	264YR7VM6W	The Lions hall -they have done an amazing job, they bought it from the Scouts.	
345	7EV5S734X5	The toilets need upgrading but that aside they have a good country feel about them, we had a good time.	
347	36XK3J4467	In pretty good condition in general, I have used a few halls.	
352	4X36NBL46B	They are well maintained and resourced and looked after well by the community.	
356	J2WDW8LUR2	The Rugby Club rooms in Cass Square, they have everything we wanted.	
357	6KG4BGW5B8	They are clean and everything looks pretty good - the RSA hall is the only one I have been into in the last year.	
361	5MK2M5TDNU	It is a DOC building really but it is used as a community hall. Donovan's Store. It serves the community well.	
362	325NDUN472	I have used a few halls, some are good some are not.	
363	82CWA4CV25	Lazer Park is still being done up so it is a work in progress.	
364	256AG8Y5H6	They are well kept.	
110	3757SPASR8	Kokatahi Hall - mainly maintained by the local committee. We need to maintain other small halls in the district.	

ID	RC	Q25. Could you please tell me why you feel this way? - Refuse and recycling service	
1	2XRMG654MU	Efficient collection.	Index
3	3H82BQQKQ4	Trucks collect refuse regularly.	
4	U2224FFPK8	Caters for all my rubbish disposal needs - only glass needs to be taken to dump but at no cost. Green waste prices are low which is very good.	
7	P666QY85R2	They are always on time.	
8	GVX74254L7	Very annoyed at the recycling rules they are inconsistent and picky.	
9	7LR78WY7B5	Works well. Rubbish could be emptied once a week instead of once a fortnight though.	
10	FDB8882NT5	Swap the bins, 240 for rubbish 120 recycling.	
11	MTCU476NKE	Due to the reduction in the types of things able to be recycled the normal rubbish bin size needs to be increased plus there should be recycling bins available for glass. Not very happy to see the council in the media saying about the three strike rule for recycling bins as sometimes there are visitors staying that put things in the bin and the home owner will be penalized big time for it.	
12	K6P56EEH6H	Good size recycling bin.	
15	NQJ27533B4	No glass collection and reduced recycling "numbers" (i.e. taking away category 4 plastic). Also no green waste collection like other places.	
18	HF23E8B8GJ	All good.	
19	57Q7744356	Glass should be taken from roadside. Reclassification of recycling should be placed on bins as residents are using the information on their actual bins which is outdated by years.	
20	P73DLWYA36	It is exactly what it is.	
22	6W5B6W3TVB	Rubbish bin is too small, should be the same size as the recycle bin.	
23	6PW48NAX62	Poor communication from service providers and no glass collection.	
24	QRHC76CTH3	The refuse bin could be a larger size.	
25	834ELHK644	No.	
26	6YAR5TG72H	There is no issues with our rubbish and recycle pick-ups. To get a perfect 10 glass recycling kerbside would really be great.	
27	PTBF52JTX5	Mine is picked up on a regular basis.	
28	825AVGB5PR	Won't recycle glass. Has to be disposed of separately.	

29	DDAH6587C6	Random times. Sometimes missed.	
30	3KE5FH3P76	Collection times changed without notice and we were left with full bins for a month.	
31	37GJ3775R2	A service provided.	
32	6D48LD2S7S	Road side collection, although last week some refuse left in the bin? Unsure why?	
36	65C628644P	It would be good to have glass collected as well.	
37	X6332J56L5	But could have glass recycling added please.	
38	64VAT555WP	No glass recycling. Small rubbish wheelie is too small! Should be collected weekly if that size. Otherwise I'm satisfied.	
39	35C2553333	They are great.	
40	54M86G63X3	I think rubbish should be weekly and recycling should be fortnightly. I notice the young families locally have a problem with such small bins - particularly if they have more than 1 child in nappies. I live on my own and still manage to have a full bin on waste day - the bin is too small - or the collection cycle is too long (for waste).	
41	5384P8T83W	Collected consistently at the same time each week.	
44	VH5435CYW4	Works well.	
45	R7658647RH	Always picked up, no issues.	
46	36P84B53VW	No glass recycling goes in with general waste.	
48	8VN8L8D53M	If you live in town, glass should be recycled kerb-side. It is ridiculous that Council encourages people to put glass in to landfill because kerbside glass recycling is not available. If council thinks its our responsibility to recycle because "its just up the road" then take advantage of that short distance and send a truck around once a fortnight.	
49	3666654NN5	Having to separate glass bottles now when we had to take the bottles to get recycled is not good enough.	
51	64W5L87428	Leaving rubbish for 2 weeks before collection becomes smelly and attracts blowflies.	
52	YU2F24Q23F	Always on time. It would be great if a glass recycling bin could be added to households instead of having to take it to the dump.	

53	P3SWVQWUU	The recycling is great. A good sized bin for the fortnight. It would be nice to be able to recycle glass kerbside as well, instead of having to go to a transfer station with it. The refuse bin we have is not big enough for our family to last a fortnight. It would probably be OK for a week. And I know we're not the only household like this. I've seen a number of refuse bins overfilled where the lid won't shut on rubbish day. While I understand it as motivation to being less wasteful and more sustainable, it's just not OK that sometimes we have to take a trip to the transfer station with regular waste that won't fit in our bin, which is an unacceptable added cost, especially with the recent rise in fuel cost. I also despise that I'm having to compost, as we don't have a garden and don't use it, so it's actually wasteful as well. I'd prefer a green waste bin, that would actually be helpful.	
54	CTCL5YBCBT	The service is regular.	
55	USRMSM38VW	When they come to pick up the bins it's all good, but around Christmas it's not clear when they come or when they don't.	
56	36G43R3455	Not sure what you can put in recycle bin as the rules seem to change from time to time.	
58	6FDJXE4GDP	It's good.	
60	QTY2JPPT76	No issues. all good.	
61	Q336266YNQ	Some of the employee's are very helpful and courteous to the public.	
62	A666XC43DA	Usually good. But can be rude.	
63	23A22P6JC4	Shame no glass or green waste collection.	
64	S2Y7GY6GC2	Dump fees are very expensive so this in turn encourages fly tipping I also understand that the Council did not take notice of community wishes re the waste to energy factory an is still looking into the pros and cons of railing or trucking thousands of tons of Christchurch rubbish to the Coast against coasters wishes. If this is such a great idea, would it not be cheaper to send the lesser amount of Coast rubbish to Christchurch?	
65	7AECJ6CLPB	Very lucky to have it available.	
66	PMA6Q5Q7XW	No option for glass recycling. Have to take them in to town each week. Also general rubbish bin is tiny and only emptied every fortnight.	

67	WS6CSX32Q4	Would love a green recycling bin. Rubbish gets very smelling attracting rodents with 2 week between collection.	
68	R3X24YR7Q2	The truck driver could be a bit more courteous.	
72	3TJLD43C8W	It's a regular fast, clean service.	
74	B5JNC2UM87	Would like to see bottle collection.	
75	3YJ7F6MVSF	Regular service. Efficient. No complaints.	
76	8S22F78CX3	It works.	
77	VL6D76V6X3	It is insufficient. Nowhere for glass.	
78	3L37MQ3J26	Quite good, but we lack a 'twice a year' pick up of rubbish from the front gate, like we once had. Dumping charges are abominable and outside the access and affordability of Seniors.	
80	5UGX3A3K2B	Could recycle more numbers.	
84	QV2YS76L5H	Bin size for rubbish and the number of bins they accept per household.	
85	T22BQ7D3N8	Driver is dangerous.	
86	4275JK5777	Great regular service.	
88	876F2CB5K7	Well once my husband put a wrong item in the recycling bin and was left with a cord showing what can and can't recycle, but some containers say the number to recycle but they say if it can fit in your hand it can't be recycled?.	
90	AHL3R2QFJ6	The collection is reliable.	
91	F58EP6T55W	Good, reliable service.	
92	J7WD6524G2	Moved into a new house, had no rubbish bin, asked Council for a new one and we're going to be charged for it.	
94	X4AEJK448L	I don't receive it as no bin here and they won't supply one.	
95	U3D5DBC48M	Always collected on correct days. Must use correct bins.	
96	435XJ8MA3Q	I find bins big enough for my needs. I understand what recycling is permitted.	
97	HG6F35S4X5	WDC recycling policy and interpretation by contractors opt for only 'easy' recyclables. Too much going to general waste.	
98	US7V7A5822	Bring back glass recycling pick-up. Large refuse pick-ups that the council did 10 years ago.	
99	ETL3AD4E5J	You can't recycle glass or garden waste like where we used to live. Also rubbish bins are small when you have a family.	

100	8F5658NRTP	Working well. Disappointed with Central Government Leadership on this.	
101	B77M46MPX2	Household waste bin should be bigger. Service is good.	
102	6T5FUTUW6A	Recycling of plastic waste requires a good hard look. Far too much plastic in the form of bags, containers and food wrap are to landfill.	
103	JH3MK5S3P2	Normally regular, unless the truck breaks down.	
104	66867BWNWM	The rubbish bins too small for a family for two weeks collection. Not recycling glass is annoying and the bin not going even though item says recycle.	
105	45E734TNM3	Fine, better if glass pick up is included.	
106	A8B83P8VS8	All okay for us.	
107	MVHGWMD7CM	The service is regular, and the bins are in an upright position after emptying, not laying down or handled roughly.	
124	LQ7G3766CV	Always pick it up no problems. Jack Ward Road.	
125	U7BU3K4CB5	Its collect every week hail rain or shine.	
127	7RLRWB7TC4	Always prompt.	
128	7BTPY766AV	There is no glass pick up, I would like that. I think lots of people are putting glass in their normal everyday rubbish which is not good.	
129	5SG6RK6A7V	They don't collect bottles and I've had a couple of run ins, occasionally they don't take it.	
130	3QJ5765K85	Generally satisfied.	
132	VPV6WSQJ2E	We are lucky, we can have two rubbish days a week if we want as the truck does one side of the street on one day on the other side in the same week.	
133	588EMC6GSB	I've got a family of 7, our little bin is our general rubbish our big bin is for recycling, we have to take glass to the dump. They dump fees are huge. I want to get a bigger bin for our household. It would be good to be able to add something extra.	
134	SK7L58GX5M	It's good, always on time.	
136	PM83823Q2B	Sometimes the rubbish collector is early. Sometimes bin emptying is messy and there is rubbish left around, this is more with the recycling bins.	
137	456C72N8TN	Always hospitable and very helpful with recycling and rubbish questions I have.	

138	RAYC44BCYK	Turn up when I expect them to.	
139	2EH4T6A26C	Always picked up on time and tidy.	
140	WV2J8J2HSV	Don't use it.	
141	57HB4847V2	We pay high rates for rubbish collection and we get a small bin only collected every two weeks, No glass collection or green waste. I think it's very poor.	
142	GV456A27S2	You can't recycle glass.	
143	6C4857423N	They keep changing the rules as to what we can or can't keep in our recycling bin.	
144	8W7D635E82	Serves our needs.	
145	X62662QKQK	We put our bins out and they get emptied.	
147	T84558QRTP	It would be nice if we had a glass collection.	
149	BJ4326F584	Pretty efficient.	
151	W2UKV68JRB	Always pick it up.	
152	Y6C8838W77	The bin is big enough.	
153	5EH446CCX7	They are pretty good. There are some good guys on the truck, some get a 10 and some get a 4.	
154	5J7V6568U3	On time.	
155	FVC3Y4G33S	The recycling bin is bigger than the rubbish - I think it should be the other way around. It's quite expensive. We are not happy about the small bins.	
156	B2H2YR82YW	I had to buy a new bin, someone pinched mine, I was upset.	
157	U6G75T53UA	They are good and consistent.	
158	DE6N88483X	Bins are the wrong size, swap rubbish to recycling size and visa versa.	
159	Y4T6SXXN55X	They do it regularly and reliably done.	
160	E82R52F8L7	NA.	
161	P8H6A5Q4LM	They are good.	

162	X2ERX738UV	The bins are too small. The bins are not taking into account the number of people in the household, they are only emptied every fortnight. They need to be bigger or emptied more often. The trucks are not consistent with their timing. If they spill something, they don't clean it up. I'm forever picking up broken glass. Because they don't take glass, people are putting it in the rubbish. The truck drivers would sometimes knock the bins over and leave it for the residents to clean up. The recycle bins are a joke.	
163	2Q52T82HDR	They are brilliant. Very good.	
164	8X3E5NT22Y	I would like the rubbish bins to be the same size at the recycling. Their service is reliable.	
165	4XH8LS6SPB	It works, bins go out, rubbish goes.	
166	3347N64L6D	They are always changing the times they pick up the bin.	
167	6SX7EY86P7	Truck driver is friendly and usually waves. The service is great.	
168	Y866Q3LE68	They come on time and regularly.	
170	426C258U5E	It's an absolute joke. There is nothing, no cardboard pick up. I pay \$500 a month to have cardboard taken away, in Hawkes Bay it was free.	
171	J4KY6P3YKD	The collection times are very erratic. Sometimes my bin is out most of the day and gets really smelly in the hot sun.	
172	CDJA4B5583	They are here like clockwork.	
173	YH7YFVDJR5	They don't do it often enough and you have to be careful with recycling which I don't think we should have to do such as taking lids off bottles.	
174	AWW62AQ34M	The bins are around the wrong way. I can fill the rubbish bin in a fortnight. The big bin should be for rubbish and the small one for recycling.	
176	P286JRDW4W	It gets collected but the timing varies.	
177	4SQBVG847R	They are always doing it, on time.	
178	8B2HAF777F	Not happy with the gestapo poking in my bins to see about recycling. The stick goes in and we get a message if we have left something dirty in there.	
179	WKM64FDYKK	They seem to do okay. They could contract in the West Road.	
181	WH84K66K5T	Put stuff in the bin and it goes.	

182	53FS6EY87H	They need to give us clearer information about the recycling. We got a notice that we hadn't done the bottles right. We are not sure where we went wrong with that. They sent a picture but we were not clear on that either. I want to do the right thing with recycling, we need clearer explanations.	
183	2QQ6HFW3FB	They are regular.	
184	NS33G7VHR6	It is satisfactory they do their job.	
186	2P54MQGM4U	They get picked up at the same time every week, never had a problem they are good.	
187	CJ35UW35XL	They put in hard work but I think it would be nice to have the option for both rubbishes to be collected every week. Our rubbish bins are not big enough. The dump fees are high.	
188	L2D2PH22VE	Poor recycling options.	
190	S8JCE8N2L4	I reckon the refuse bin is too small it should be the same size as the recycling bin especially as it is only picked up once a fortnight.	
191	27N784YF72	The recycling is getting very restrictive and it doesn't seem worth doing.	
193	67R33EN3J2	They seem to religiously pick it up.	
194	M2W4876DV2	They pick it up as promised each week.	
195	DT28MAD2M8	The recycling bin is fine but the rubbish bin is too small.	
196	46C754P4NL	You have to drive to where the E-Waste and Glass are collected. They have set these things up for everyone who drives, but I don't drive I am sight-impaired.	
197	PAU87M336U	They don't collect glass so can't give them a 10 otherwise they are regular and efficient. I wish they would set up a recycling unit on the west coast.	
198	5N242MY7M3	Bin collection 10 out of 10. Every Thursday we have a bin collection whether it be general waste or recycling on alternate weeks. The old dump site is for steal and glass and I am very happy with them.	
200	PKL6V82LAQ	Contractors used by Council have told us directly that it is their policy to throw wrong items on the road. The gaps between the houses can be up to 500m away, so we then have to go out and pick up everybody else's rubbish. The contractors became violent and threatening towards us when we asked them to stop doing it. I rang the manager who told me to go away. They want our money but don't want to provide a service.	

201	8Q78GWK2J7	Very good collection.	
203	43GWDN347K	I used to live in Christchurch and knew what to put in the bins. I put polystyrene in the recycling and it wasn't collected. I am a bit confused about this and would like clearer explanations. They don't recycle the bottles, so we do put them in the rubbish.	
204	L2N2APH5X4	We pay extra for recycling and now they don't do it and also the bins are the wrong size - the rubbish bin is too small.	
205	E25NH74J35	The rubbish bin for general waste is too small. You try and keep your section presentable cutting back plants and trees and there is not enough room in it at times.	
206	YB27FDA73N	Good, it's handy.	
209	G784D2BM76	There is not enough such as bottle recycling. For a family the rubbish bin is too small. It needs weekly emptying for the size of it.	
211	2635ES2B37	I have never had an issue, it's consistent.	
213	4UG22H6577	I would like a bigger rubbish bin. The dump fees are really expensive. We don't dump rubbish around the place but I know a lot of people that do because the dump fees are so expensive. They used to have a free day where you could put stuff out and the rubbish truck would pick it up for free but they don't do that anymore.	
214	5JT884783L	Its a good service.	
215	6Q6KD7CS2Y	There is no glass recycling. There should be a move towards much better education about recycling.	
216	7EPNE68RL3	We need a larger rubbish bin.	
218	XTE4DV4N67	I have never had any trouble with them. I put the right stuff in the right bin.	
219	PX4U2527J7	The guys are really courteous they are put down nicely not falling all over the place. They are good men.	
220	JWG88HH5R6	They have brought in glass recycling, but there is no separate collection, it seems quite haphazard. I would like to see the light plastic recycling brought back. They go through your bins with a stick. The times are not regular.	
222	J3J5245PKG	We have it twice a week, they bring down a skip.	
223	44C4274N37	Its a regular service.	

224	B2VV7VAC66	It's good. there are always here.	
225	R4866LMG46	I have had garbage left behind in my recycling and refuse bin. I think that's because the bin hasn't been shaken enough.	
227	VLK4277643	They collect on the days they should and we haven't had any problem at all.	
228	Y8VS5DP4QX	I have no problem with it.	
229	B66QWYY5A3	They poke around in my recycling, I don't like that.	
230	8T73352N2S	It allows me to get rid of what I can't get rid of by composting and burning paper. So it is handy for some things.	
231	MA3MNV5G6K	The rubbish bin needs to be bigger.	
232	W2846MBGT6	They are not regular with their times.	
233	6N823PSCYD	I put it out and they pick it up and I don't have any trouble - they just take it and leave the thing and I put it back.	
234	2K5UUH3A38	We recycle a lot we only put our wheelie bins out once a month so what gets collected I am happy with.	
237	34R44PR7BC	It is well done we use the recycling and I think they have improved things quite a bit. Quite happy with the service.	
238	535236444W	They are brilliant.	
239	C6XTP2S2VT	Collection is always on time.	
240	H45DR6Q7CL	I have never had anything refused from being picked up.	
241	6JTWG57DQ7	Like that a man is going around and checking all the bins, to make sure they are putting things in the right bin.	
242	N86ER5Q8N6	I am careful with what I put out. It's only once a fortnight.	
243	Y7E4F7GX3V	They are excellent.	
246	FXJWRQGK66	If you stick to the rules your rubbish gets taken away.	
249	35APA22B6C	Its regular and like using bins.	
251	32J3D3NDE7	They give us a small rubbish bin and a big recycle bin. It should be the other way around.	
252	X8KEV73H64	It always gets picked up.	
253	K3VH48J5G5	The contractors do a good job.	
254	5H7T368E7Q	They are good. They pick up on time and don't leave a mess.	
255	533KA6HWM7	They do a good job.	

256	3678C7S5DJ	It comes through fairly late in the afternoon I only use it once a month, if that, as my bin doesn't get full. Even when I do put it out it wouldn't half full.	
257	F5TAMAFTFM	They seem to pick up alright and don't leave anything behind.	
258	57BVPQ3LG5	Always regular always taken away.	
259	CT6N53CTB5	Everything is done promptly, there is never any mess it is just good. Reliable and things are put back nicely.	
261	PU7K2T856P	They should have put the bins around the other way. The recycling should be the small bin and the rubbish the big bins.	
262	87M8D3Y3XA	Always on time.	
265	4JKD4LBAG5	They are regular, they are clear about what you can and can't put in. If you have to go to the dump they are friendly and helpful.	
266	B8PAL2GC2E	They are regular.	
267	4AAETXCE52	It works.	
270	7SBT545PMM	The rubbish is picked up only once a fortnight and the rubbish bin is too small.	
271	J42P5854WQ	Can't complain about it. The rubbish bin at times is small for me.	
272	78AE8KNQH2	Regular service at my doorstep.	
273	4M38RHG62Q	I am very happy with the service.	
275	88U48N2668	I don't produce much and it is always collected. There has been the odd occasion there has been heavy winds and rubbish has blown down the street but that is hardly the fault of the people doing the collection.	
276	W8AQ5R67Y2	They are really good they are on time, they take the rubbish away and if anything is too big we can go to Hokitika and dump our rubbish. It doesn't really cost too much to dump your rubbish I don't think. Mind you I haven't been there for a while.	
277	Y73Q3CU7W6	They are trying to reduce waste. They should have looked at a waste energy plant here.	
278	V56F7D2Q3D	They expense of the service.	
279	BRT5377RB2	The household rubbish bin is not big enough especially when my children were here and they don't collect the glass.	
280	2437XK4KYJ	The garbage bin is not big enough.	

281	PENY3T2G66	That's great, they are regular, they are on time and we know when they are coming.	
282	YC2R644387	Its a good service.	
283	FSK7TSGQT5	The rubbish bins are too small, the recycling is too big and they don't recycle glass. I dump the glass in the rubbish which I know is bad.	
284	P47N5FJRVX	I just do all my own I burn it all.	
285	7Q7LA43835	They do a good job.	
287	K5JSH84Y3N	They are always timely and always keep you informed. The service is great.	
288	X8TPY5L4Q4	I would like a bigger bin.	
289	CQB8C3BW84	Because they are very good at what they do apart from the day he wouldn't take my plastic that had been wrapped around the couch.	
290	8UXTAV88UK	The general rubbish needs to be collected once a week and not once a fortnight as they are quite small.	
291	5MK7TD7M47	It's good, they are on time.	
292	7S55GJ58HV	I'm quite happy with it. The general waste bins could be larger.	
293	L5NNC43B46	They pick up my rubbish!	
294	JWBMH76AQ8	They prompt and get the job done.	
295	3VV67QH5QG	There was a guy looking in our rubbish, I was surprised.	
297	KCU5S46U5E	They provide a good service.	
298	QB5E7J77DV	They do a pretty good job, always on time.	
299	22538TJ3D8	Because they collect it every Tuesday morning. They empty it all the time. I have read in the paper where different items had been placed in the wrong bin and that is a no-no. They give us two bins one for rubbish and the other for paper, cardboard, and tins and we put them out alternative weeks.	
300	4L5S6G66FV	They give quite a good service.	
301	688P4R4224	I would like more bins because it is a commercial building and my rates are exorbitant for just the refuse collection.	
302	763D7YL82Y	They are very regular and it just happens - there are no issues.	
306	DDV2HT7C22	I have had no problems.	
307	B5CULLP7AY	Because we only have cardboard and plastics for recycling and no bottles, otherwise I would rate them higher.	

308	QD3TK637P7	It's always prompt and the bins are left standing.	
309	QLS573GN28	They are quite good. No problems here.	
310	6BQ3VTVMNU	They pick it up and take it away!	
311	37F8SHB673	I've never had any problems with it.	
312	G55LA65TF3	They are good, really well done.	
313	FT6N23445V	They are always regular.	
314	343E225W2S	They are efficient.	
315	7D3VG8X728	The recycle bin is too big and rubbish bin too small.	
316	6323R7V86N	They take rubbish away.	
318	H6NLEH4DGV	Very pleased with them. They check our recycle bin which I am happy with.	
319	47H7M86N3Y	I have no reason to complain.	
320	BC26P2B2Y2	The rubbish bin is too small and needs to be emptied more often. We could do with a bigger rubbish bin.	
321	T3Y8W7A4B7	We never get missed and they make a clean job. If they spill anything the pick it up.	
322	R5PYBLW726	Quite satisfied with it.	
323	7L8Q227KQN	It's fine.	
324	332RC574B4	They collect on time but I think the rate payers should be able to dump rubbish for free as people are dumping anywhere. Other districts have a green bin, I think it should be free here for dumping green waste.	
325	W8AGL24Q65	It's always picked up.	
327	55V334QH5E	They don't leave any mess behind and leave the bins standing upright.	
329	22XLP75L26	I think they are pretty good. It is not perfect. In the big cities they have grass collection and things like that.	
330	RXGE7NGN6F	I am quite happy with it - I daresay it is a convenience thing to sort out your bits and pieces, it is good.	
333	8Q2HQW3NU7	I don't use the collection but they do provide it.	
334	EFH878538N	They don't leave any rubbish in my bin and that is really all I use them for.	
335	546WDMFKVS	It does the job properly and efficiently.	
336	282L73HFGF	It's regular.	
338	M53YV7APJK	I get pissed off with them when they sticker you. They never said don't put your newspapers in a plastic bag for sorting.	

339	HG7T57JP7N	They turn up and do their job, no problems.	
340	6R84Y8YQH7	Relatively pleased with the collection.	
341	76YESW52T7	They are on time.	
342	6W7D633T4E	They are very clean and don't make a mess. They are regular.	
343	H6568442JC	They are great.	
344	264YR7VM6W	They turn up every time.	
346	A62R6KJA5T	It's all picked up every week. No complaints.	
347	36XK3J4467	They are efficient and a good service. We don't have a glass collection which is a shame. It seems to undo all the good effort with recycling.	
348	WQ5ENR277V	There are some things such as glass that aren't collected.	
349	77YE28M733	They are regular and the rules are clear.	
350	2RB5EH467J	Our rubbish bins are a wee bit small seen as it is only collected once a fortnight.	
351	P338684522	They are always on time.	
354	L2J538668W	Because it is always reliable and they make it as easy as they possibly can for us.	
355	GN3AG8WR23	It's terrible because the recycle bin was recently checked and I got stickered for my glass. We need a bottle bin.	
356	J2WDW8LUR2	The small rubbish bins should be bigger but I understand they are wanting people to recycle and think about what we are throwing away.	
357	6KG4BGW5B8	I don't like them picking up our garbage once a fortnight. I believe it should be once a week, especially in the summer.	
358	32SVGKB8P7	They are very good. The recycling is fine and I like they check to make sure people are doing the right thing.	
359	4HE3TK7VYL	I think they do a good job.	
360	TS8NPE3462	They have changed their hours on the recycling, I missed the collection the other day.	
361	5MK2M5TDNU	It is free. It is regular and never fails.	
363	82CWA4CV25	It is great - it means I don't have to cart my rubbish into town.	
364	256AG8Y5H6	They red stickered me on my recycling. I think there was one thing wrong, I could only see a dirty lid.	
365	7CAPDJ8M83	There are no hassles. If everyone learns how to recycle there will not be an issue really, it is really good.	

69	4JAS5KYASF	Fortnightly is not regular enough and if they spill refuse while emptying bins they don't clean it up. The pick up times in my street can vary some 5 plus hours 7 am to approx 1 pm. Very seldom same time bins are too small for refuse and too choosy for recycling. I don't know one plastic from another.	
109	KA82BEBU26	There is a need of a green bin for garden and food compost.	
111	MJG8F4JV43	Recycle bin is bigger than rubbish bin but more is dumped than recycled.	
112	55SPBL7SP5	Recycle rubbish is checked.	
113	3GTK5ESA84	Sometimes times differ throughout the day but always collected on the same set day. No issues with not being collected.	
114	NQKM2PKP8M	Green bin is not big enough for grass clippings, too expensive to dump.	
116	JXBBW63T4W	Ability to recycle is pointless - can only recycle paper. Bin is too small for general rubbish. Collection times are too irregular on collection day.	
117	35A5E3548G	The recycling service is not the same as other Districts. It should be the same.	
118	7V8E3W6MS4	Would have rated this a 10 except that for a period a few weeks ago the timing of the collection changed - therefore missed the pick-up.	
119	T22KRQELN5	I have to take my bins out to the state highway, it's too far for me.	
120	UP62Y7LN68	I feel strongly that Council should provide food scraps/compost recycling and soft plastic recycling and collect glass at kerb.	

ID	RC	Q28. Could you please tell me why you feel this way? - Quality of advice received regarding environment health (i.e., food premises, camping grounds, hairdressers)	 Index
15	NQJ27533B4	Called noise control after hours, it went to a call centre in Auckland that had never heard of Hokitika and claimed they don't deal with complaints for Westland. Also reported fly tipping and took over 2 months to get any action which took a further complaint to actually have anything happen.	
30	3KE5FH3P76	Dealt with well.	
34	2383T8RB3Q	I have known the person I generally contact for a number of years and know that at least I will get a quick and honest response.	
38	64VAT555WP	Rang noise control. Said they would handle it. No issues.	
44	VH5435CYW4	Good service.	
174	AWW62AQ34M	They wanted nothing to do with the issue which was toxic substances being pumped out to sea. I know it's toxic as I used to deal with it.	
212	BNSVGVR5H2	The council has changed the water courses which has led to flooding. This has caused contamination from a trucking company across the road into the neighbouring land on the other side of the road. I have no faith in our council.	
213	4UG22H6577	When I rang them they said they had to come from Greymouth which is totally ridiculous when you have got music blaring in the middle of the night. I don't know if they even bother coming.	
246	FXJWRQGK66	Broken glass, the council didn't respond to sorting this. I finally approached the workmen and they sorted it before mowing the lawns.	
254	5H7T368E7Q	About a six weeks ago I slipped on the wet bricks and damaged 3 ribs. I am still recovering. I rang the council, they don't seem to have sorted the issue. I must have jolly good bones. It was opposite the chemist.	
257	F5TAMAFTFM	They were good with the situation, they dealt with it alright.	
298	QB5E7J77DV	It was about a water leak and I never received a reply but if could have been when we were isolating for Covid.	
305	TK5V44Q57X	They never came back to me in regards to spraying waterways with roundup. I spoke to one of the Councillors and that was the end of the matter.	

307	B5CULLP7AY	They acted on our complaint but the issue is still not resolved, it is a work in progress.	
355	GN3AG8WR23	This was regarding contamination into a lake and they ignored it, they are killing the Lake Mahinapua with run off from farms and mining.	
114	NQKM2PKP8M	We had neighbours take our bin and we had none to put our rubbish in.	

ID	RC	Q31. Could you please tell me why you feel this way? - Quality of advice received regarding liquor licensing				
8	GVX74254L7	██████████ is very good at his job.	Index			
44	VH5435CYW4	Good service.				
154	5J7V6568U3	I thought it was a bit vague and airy fairy.				
176	P286JRDW4W	I never heard back. I put a submission in and never heard anything.				
191	27N784YF72	The person I spoke to didn't have the knowledge that I required. I didn't get satisfactory information.				
209	G784D2BM76	It was fantastic, they guys were on to it. This was for liquor licensing.				
237	34R44PR7BC	██████████ is very attentive and takes the job seriously and is very easy to deal with. He is an excellent employee for the c				
277	Y73Q3CU7W6	I was refused to renew my license because I wasn't a practicing bar person.				
280	2437XK4KYJ	It takes too long for a license to be renewed or granted.				

ouncil.

ID	RC	Q34. Could you please tell me why you feel this way? - Quality of advice received regarding building consent	 Index
4	U2224FFPK8	All requirements were clearly advised and appreciate the pressure building department are under to meet Government requirements.	
14	54GBDSTCK2	Too much mucking around, it takes forever.	
19	57Q7744356	Overhaul of renovation consents need attention - renovations are not new builds and should not be treated the same.	
21	VNUSJ4AV65	Some people in this department seem to want to make life hard, not helpful at all and I have been passed around various people where once I got the right one, that was very helpful, got everything sorted. In their words "I'll just go next door and sort that for you (to the person that passed me on). Yes after a month it was sorted "consent over hooking up to an existing stormwater pipe".	
41	5384P8T83W	The queries were answered adequately.	
42	5DUN8473FX	Very difficult to actually speak to anyone over the phone. Got transferred to phones that no one answered. The Alpha One system is VERY hidden on the website, there really should be a clear link on the Homepage. Also doesn't come up when using the search bar.	
50	75UK66R6MG	I work in the building trade so contact the Building department on a regular basis.	
52	YU2F24Q23F	Rude and belligerent staff member, very unhelpful and it was incredibly frustrating that the Council would wait until the very last day to respond to our submission which held up a lot of building processes. There was one very helpful and knowledgeable person who we got to deal with near the end of the build which was a huge relief.	
57	VB8445N866	Slow moving. Appears to be an ethos. I'm not complaining. Think about it please.	
74	B5JNC2UM87	Took longer than expected. Repeated requests from council regarding information.	
76	8S22F78CX3	Very slow, ask questions one at a time leading to delays.	
86	4275JK5777	Good quality advice provided, regarding building consent matters. Resource consent processes were a bit harder to understand.	

93	H5CRN8B7GM	I know there is a Covid-19 pandemic upon us, but there are everyday queries that need advice and it would be quicker and easier to make decisions with a face to face chat without filling in forms and paying money. Why can't you give straight answers or say if unsure. It is frustrating and time consuming.	
104	66867BWNWM	Staff need to be more helpful in explaining rules and the cost of consenting is too high.	
105	45E734TNM3	Slow.	
141	57HB4847V2	They told us to look on the internet, they didn't even come down to talk to us. Then charged us a fortune for planning and tried to bill us for commercial rates.	
150	UGL6JFM7Y7	Very costly service to build a barn. They didn't want to really deal with me.	
152	Y6C8838W77	The girl I spoke to was helpful. I was booking an inspection.	
154	5J7V6568U3	I rang and got nowhere with the phone system. You have to be desperate to ring that Council. Unless you know the extension numbers you are stuffed.	
172	CDJA4B5583	They are not listening to the peoples' requests. They keep charging me for services that are not required. My building is mothballed and is not occupied but they are still charging for everything and I think it's wrong.	
192	UJAREF753S	It was difficult to get anything done. It was just one thing after another and wasn't given the entire picture in one go. A lot of back and forth for no reason. It took longer than required.	
200	PKL6V82LAQ	It took over 2 years to get a response from the Council regarding a business running from my neighbours illegally. I am still waiting for a response. I tried to resolve it myself first.	
203	43GWDN347K	It was about a renovation from 4 years ago. We got a bill yesterday for \$80 for ensuring that we met the conditions of the resource consent which was signed off 4 years ago. We are now in dispute with them. When we did our renovation, the building people we had, so hard to deal with.	
207	3HJCND837D	It has improved in the last year.	
253	K3VH48J5G5	The department is short staffed. I have never had an issue with them.	
262	87M8D3Y3XA	They are quite fast to respond and very accommodating.	

268	K3753624GS	I am pretty happy with the procedure.	
306	DDV2HT7C22	Good communication.	
314	343E225W2S	We have had to get lots of extensions on our build, this has cost us lots more money.	
320	BC26P2B2Y2	The guy didn't know what he was on about and he has now left. They made life difficult. They came back with the problems without build, but didn't list them all at the same time. It was just unbelievable and we went back to the bottom of the pile. This happened more than 3 times.	
333	8Q2HQW3NU7	Minus 20 would be my real rating. I have done subdivisions and each stage becomes more difficult, horrendous and most recently our build is a nightmare. The issues we are dealing with now are downright mindless. A lot of this stems from Central Governments rules and regulations. I think Council need more autonomy and more flexibility and more people with actual practical experience.	
341	76YESW52T7	They could have been more efficient and timely.	
345	7EV5S734X5	They answered all my questions, gave me the right advice and completed my building project happily.	
350	2RB5EH467J	I haven't gone right through the process yet but the person I dealt with was very good.	
69	4JAS5KYASF	Make it too hard and almost don't want to work with you. Rules also vary.	
110	3757SPASR8	Website difficult to negotiate. Not straightforward - can't see a simple pathway forward. Rang council - staff not helpful, referred to website - seemed unwilling to help. Front counter staff were not helpful either, couldn't see/book in with another staff.	
113	3GTK5ESA84	Takes so long to achieve anything/get answers. Nobody seems to know what anybody else's role is. Poor communication. Saying I had been issued instructions but hadn't done it. Have to chase everything up yourself. No follow up.	

ID	RC	Q38. Could you please tell us why you gave this rating? - Performance of the Mayor and Councillors?	 Index
1	2XRMG654MU	Still seems to be a bit too much of a one man band. The Mayor needs to represent the views of all, not just his. The Revell Street debacle is a prime example of this. If he had been upfront in the first place and admitted it was to be permanent feature people could have accepted it - as it was the constant attempts to hide that fact were appalling. A very poor attempt to handle a potentially divisive situation.	
2	X25A3345RD	Yeah nah.	
3	3H82BQQKQ4	Money not spent wisely. Very disappointed about putting the one way system in Revell St. Money could have been better spent on the garden plots in town centre. They are poorly planted and kept. Never use flax in garden plot regardless of it being a native, it's a very untidy plant. By all means use native plants and use our natural rocks as features in the plots. Use washed aggregate as ground cover.	
4	U2224FFPK8	The Revell Street debacle should have been discussed with the ratepayers/business owner PRIOR to work being undertaken.	
5	LW76DQBE76	They chuck money away on daft ideas and infrastructure goes backwards.	
6	8RPPR24Y7T	I think the Mayor is bias and doesn't attempt to understand situations that people might be in. The Mayor has also painted Westland as doom and gloom on television (due to no tourists) and this could have put off New Zealanders coming here. The money being spent is on things that are very superficial. It seems to be all about looks and tourists rather than looking after facilities for the people who live in Westland.	
7	P666QY85R2	Controversial purchases of unsuitable buildings.	
8	GVX74254L7	13% rate increases cronyism favouring a fortunate few with there noses in the trough. A mayor who sues people who disagree with him people with little ability making decisions that make no sense.	
9	7LR78WY7B5	New mayor needed.	
10	FDB8882NT5	They don't listen to the community stuck in their little circle.	
11	MTCU476NKE	The leadership leaves a lot to be desired.	
13	H4RR2WK3J4	I don't know.	
14	54GBDSTCK2	Too busy limelighting and looking after themselves.	

15	NQJ27533B4	Too much money time and energy spent on poor ideas like Revell Street one way. Also dishonest bunch claiming there would be more parking with this poor idea when there is now less parking.	
16	FS75M2K5T5	Very little help/funding for the smaller towns. Hokitika gets and big tree and lights every year. Hari Hari's Xmas decorations are in tatters. After being left up till almost April, and we had none this past Christmas.	
17	55S8283EP8	Hari Hari's Christmas decorations are in tatters. We didn't even have any this past Xmas. While Hokitika got a huge tree and lights. We have no recycling, and people are burning rubbish, including plastic, because we have to pay. While paying rates. They burn rubbish next door, it stinks and it's bad for the environment.	
18	HF23E8B8GJ	Not interested although that one way system seemed like a waste of money.	
19	57Q7744356	Focus must be placed into a commercial rather than changes that have zero impact on the wealth/benefit for the people who live here.	
20	P73DLWYA36	He thinks he is a tourist promoter driving around in his Mayoral car with dash cam on, when he should be in his office doing his elected job.	
21	VNUSJ4AV65	Bruce Smith does a great job and very happy he helped reject the Three Waters rip off. Councillors the past have wasted a lot of ratepayers money but I guess with the great lack of funds at the moment, seem to be focusing on the basics.	
22	6W5B6W3TVB	With rates becoming unaffordable the performance is low.	
23	6PW48NAX62	Silly decisions like for Revell Street detract from otherwise good aspects, good work by Mr Smith regarding Three Waters.	
24	QRHC76CTH3	To my knowledge there was no consultation by the council when the shrubs and plants and flower gardens were pulled out and not replaced. It was stated in the local paper that the children's playground was going to be upgraded but nothing further since then. In my view all council has been and is concerned with is changing Revell Street at the south business end to the one way road system, adding seating and planters, against a lot of local opposition. A complete waste of ratepayers money. The wooden planters were later removed, where to, don't know.	
25	834ELHK644	No.	

26	6YAR5TG72H	No consultation (with our business) in commercial area regarding massive change to Revell Street between Hamilton and Weld Streets. Too much money spent in this small area and nothing has been done for years fixing potholes, footpaths and car park toward river end of Revell Street 200 metres away. I was taken aback to have the Mayor's involvement in an online service request regarding someone planting during Level 4 Lockdown in August 2021 (the owner's accommodation business, not residence) in commercial zone area outside their property boundary on Wharf Street. No response until two months later by transportation officer, advised by CEO and Mayor to give approval of plantings.	
27	PTBF52JTX5	No.	
28	825AVGB5PR	No real community engagement and complete lack of democracy and transparency. Appears decisions such as Pakiwaitara, Three Waters and Revell St trial not fully consulted. There appears to be a disconnect between council executive and council. Executive seem to have their own agenda that usurps the councillors involvement. Councillors just seem to rubber stamp the Mayor and executives' own agenda. Unable to control costs, e.g. Pakiwaitara and Revell St one way trial.	
30	3KE5FH3P76	Not really had any associations with them.	
31	37GJ3775R2	They do not provide kerbside mower when the council owns the land. They should engage a person to do this or incorporate it into the mowing services of the employees that do the cases square grounds.	
32	6D48LD2S7S	I try not to think about it, there is enough going on in my life without worrying about the performance of the elected councillors.	
33	TH2WQ55K88	Don't listen no one wants 30km speed limits or one way streets.	

34	2383T8RB3Q	While I'm sure Council does its best within legislative and financial confines I'm concerned that Hokitika has more done for it in terms of expenditure and work per capita, than any other rural town. Volunteers in the town I'm associated with are the main drivers of improvement/maintenance - much more so than Council. I'm also concerned that the current Mayor, while I'm sure he has done some good for the District and in promoting the District, finds it hard to separate his Mayoral role from his personal agendas on his Facebook page. I am concerned that he has used this platform to slam residents as being "greenies" or not aligned to his way of thinking, but who are still ratepayers and valued contributors to the community they live in. By using the page in this way his opinions appear to be supported by the "angry ignorant" (those who don't take the time to research the facts). I'm hopeful the next Mayor will have a more "in role" focus and less of a focus on promoting his/her own beliefs and agendas.	
35	LBBVEH73DC	It seemed like there was very little or no public consultation for Revell Street, which most of the locals I've talked to are frustrated about. The Mayor runs a Facebook page on which he often bags DOC, provides incorrect information, blocks anyone who wants to open the table for discussion and he uses the page to express his personal opinion on council related matters. That's the key thing there, not listening to and representing the people. It's literally the job of the mayor and councillors. Listening to a portion of the people (because they blocked/banned the ones they didn't like) is NOT representing the people. There are very few ways in which I see the council actively seeking public opinion in a structural and all-inclusive format.	
36	65C628644P	I think they have performed well in trying times. There needs to be a better overall plan for how our towns future and how we want to present ourselves to visitors.	
37	X6332J56L5	Have an excellent representative in [REDACTED]. She attends all our community monthly meetings and takes and gives feedback to the council for the Ross residents.	
38	64VAT555WP	Rates going up, never good for ratepayers regardless.	

39	35C2553333	They are all great.	
40	54M86G63X3	I used to be a management consultant looking at the effectiveness of local councils (in the 1990s and early 2000s). The Mayor and Councillors lack effective communications capabilities and give the appearance of adhoc/uninformed decision making. They appear to have inadequate capability in terms of macro decision making and interactions with macro issues emanating from Government local body people/policies/initiatives. They give the impression of a stale old boys network focusing decisions and resources that will benefit their ideologies, mates and egos, rather than the wellbeing of their community. Excellent example of pavlov's dogs though.	
41	5384P8T83W	The Mayor communicates well via social media - although his speeches could be shorter. The one way "trial" on Revell Street has let them down. This is an absolute joke - that kind of money would have been better spent in other areas of our community that actually need it.	
42	5DUN8473FX	I don't really follow/pay attention to that.	
43	BW23G6Y52S	No one has canvassed or visited my area. I've no idea who the councillors are or what their agendas are - rural areas seem to be forgotten about in all aspects of Council.	
44	VH5435CYW4	Looks like they know what they are doing.	
45	R7658647RH	No issues.	
46	36P84B53VW	No one is perfect.	
47	Q5AWMQ5625	Very good Mayor - proactive and a realist.	
48	8VN8L8D53M	Ho-hum. Neither here nor there. I know our Mayor makes a lot of noise but I don't see many things useful to me come out of that office. Sure he wants to catch the "big fish" so to speak, but we want to see improvement, growth, and a positive outlook for the future at the ground level too.	
49	3666654NN5	I have nothing to comment on.	
50	75UK66R6MG	There is always room for improvement but generally I am happy with our elected representatives.	
51	64W5L87428	Because they don't listen to ratepayers views on a number of projects.	
52	YU2F24Q23F	The Mayor and Council appear to be transparent in their roles.	

53	P3SWVQWUU	I've not had much interaction with local government since moving here. I've only heard things through word of mouth, and what I heard was mildly concerning, but obviously not enough to take it further.	
54	CTCL5YBCBT	There have been some contentious issues.	
55	USRMSM38VW	I have no idea what the Mayor does and I only know one councillor that I do not talk to him about his job.	
56	36G43R3455	Wasting a very lot of money they haven't got on things like on a one way street that's just a complete mess that has cost the rate payers unnecessary money which they haven't got.	
57	VB8445N866	I selected poor so I could comment. Council appears to have little in the way of positive communications, planning, sell yourselves. Stop hiding from the challenging individuals. Is the newspaper the best vehicle?	
58	6FDJXE4GDP	No issues.	
59	E87LH5NUE2	Own agendas at times and don't appear to listen to anyone questioning their decision.	
60	QTY2JPPT76	I think Bruce has our best interests at heart.	
61	Q336266YNQ	They are more interested in boosting their egos than listening to the public. Spend money on projects instead of the core council priorities.	
62	A666XC43DA	I feel they all work for their better good but not the community and where it matters.	
63	23A22P6JC4	Some good decisions work around Westland Cycle Trail. Poor decisions around kerbside mowing, pool palms, too much money wasting on some projects.	
64	S2Y7GY6GC2	They do not listen to the ratepayers wishes, they bought the Pounamu building for a million dollars even though they were advised that this was not a good building and now they are looking in excess of 5 million to bring it up to standard required. Ratepayers were clear in a survey done that they did not want this building.	
65	7AECJ6CLPB	They have a difficult job to do and do it well.	
66	PMA6Q5Q7XW	Great connection with Latham, lots of communication about what's going on and how to get involved. Haven't heard anything from the Mayor since he was elected.	

67	WS6CSX32Q4	Very high rates compared to house values in Westland district. Money spent on making things look pretty rather than essential services.	
68	R3X24YR7Q2	Bruce Smith has done the best job so far.	
70	J2W528644C	Wasteful spending.	
71	UFK8ACBNBG	Not as bad as the previous year.	
72	3TJLD43C8W	They are about average.	
75	3YJ7F6MVSF	Most are trying to do a good job, in a very demanding environment with limited funding.	
76	8S22F78CX3	Improve public comment.	
77	VL6D76V6X3	He did what he wanted, not what the people wanted.	
78	3L37MQ3J26	It lacks any respect for Government of the day, especially in it's National like incessant rubbishing of Government policies, which are forward planning. There is no thanks coming for their keeping Kiwis as safe as possible.	
81	2K85SG7R67	I have really noticed great communication through social media, especially Latham. I don't follow anyone else, so hopefully they all do the same.	
82	R52SAB6L4H	A difficult job, we are kept informed through the post and local paper.	
83	EAA37W4P2P	Not enough communication with rate payers.	
84	QV2YS76L5H	Feel they are trying to do their best in tough times.	
85	T22BQ7D3N8	Great Mayor!	
86	4275JK5777	I feel there was not enough community engagement by the Councillors over the last year.	
87	8824AJTSDK	They are doing a good job.	
90	AHL3R2QFJ6	CEO Simon seems to be doing a good job.	
91	F58EP6T55W	Too much infighting.	
92	J7WD6524G2	Spending an endless budget on a one-way street that no one wanted.	
93	H5CRN8B7GM	Covid-19 restrictions are tough on everybody but using money to fix infrastructure from Government handout should have been used more widely for job creation for future generations.	
94	X4AEJK448L	Too much fighting and wasting of money.	
96	435XJ8MA3Q	Revell Street one way felt rushed, looks completed. Not really a trial.	

97	HG6F35S4X5	Unwillingness to accept other alternatives and differences in opinion. Outcomes are predetermined. Breaches of Bill of Rights and LGOI and M Act.	
99	ETL3AD4E5J	Made some average decisions around what to fund.	
100	8F5658NRTP	System seem to be working well.	
102	6T5FUTUW6A	Mayor and councillors not always able to reach consensus on various matters.	
103	JH3MK5S3P2	When council wants to change something in town and the majority is against it. Don't do it. i.e. Revell Street one way system.	
104	66867BWNWM	I don't really see what they are doing.	
105	45E734TNM3	Just do not appreciate the Mayor and his attitude.	
106	A8B83P8VS8	It appears to me the Mayor & Councillors' have become involved in a lot less business activity of Council. There has been far too much passed on to C.C.O like Destination Westland to make decisions for the future of some important Council activities. These decisions only have input from a small group of staff advising on issues. Councillors were voted in by community to represent them on all aspects at Council. They should be elected for their skills to represent us. Not farm out to another layer of paid people to make decision for us.	
124	LQ7G3766CV	Not satisfied with their performances. The whole way of standing and not involving the rate payers in most of their final decisions.	
125	U7BU3K4CB5	Pretty good actually. In the present circumstances they have actually done their best with what they have to deal with.	
126	6274MWB7N2	They are being seen, and they are always in the paper so you know what is happening.	
127	7RLRWB7TC4	In relation to the Revell Street development, they have not told us the truth. They are treating us like we are their servants. They are not letting us know facts we are entitled to. I think this is out of character for the town.	
128	7BTPY766AV	I think our Mayor goes off and does what he wants. He makes decisions without consulting people. A good examples is the work he has done around Franz regarding the flooding. He did it himself without even consulting the Council members.	

129	5SG6RK6A7V	They are doing a reasonable job. Not enough people to cover the rates to fund the infrastructure.	
130	3QJ5765K85	The attitude of Councillors and disrespect for rate payers. They show a lack of consideration. There is no concern about the costs. I feel like they say stuff the rate payers. From 2018 to today my rates have gone up 42.2% in that period. There doesn't seem to be any effort to control Council spending at all. I've tried to change this and I failed miserably when I worked for the Council and there was no consideration for the ratepayers. It's all about the staff. There are over 60 staff for 3,500 people. The Mayor is not interested in cutting costs.	
131	VB7BP2867S	The Mayor is okay I'd give him an 8, I don't know the Councillors so it's a lower score.	
132	VPV6WSQJ2E	Pass.	
133	588EMC6GSB	Some things are really good such as having a present Mayor who is seen. Other things are not good, such as putting in one-way streets in Hokitika. They haven't been wheelchair friendly with footpaths. Our Mayor is known for being the Social Media Mayor for the country. We get to see his Social Media posts, which are amusing, some of it is informative but generally just entertaining. Nowhere for the teens and elderly to go in town.	
134	SK7L58GX5M	They mucked up one of our streets making it one-way. It was meant to be temporary and it is permanent. We are not happy.	
135	52A4K3X883	I think they have spent money places that was unnecessary such as the one-way street.	
136	PM83823Q2B	The Mayor seems to be doing what he says, looking out for the coast. The Facebook things he posts are cool.	
137	456C72N8TN	He's not my favourite person. I think he allows too much personal opinion. He's not a businessman and I feel he oversteps the mark quite considerably sometimes.	
138	RAYC44BCYK	I don't like what the Mayor has done to Revell Street.	
139	2EH4T6A26C	I have no complaints. The town looks pretty good. They are back to mowing the lawns.	

140	WV2J8J2HSV	They have got good money from the Government. I don't think they have done a good job on SNAs. I think they need to stand their ground in relation to SNAs.	
141	57HB4847V2	They managed to spend lots of money for very little gain. Doing projects that don't benefit the town. Our footpaths need doing up. Dog control needs to do a proper job. We seem to be paying very high rates for very little benefit. The money appears to be spent outside of town.	
142	GV456A27S2	Sometimes they are good, sometimes they are terrible. They are good at spending money, not on the correct things. Sometimes we need to stick to the basics.	
143	6C4857423N	The debacle over the Revell Street change to one way traffic.	
144	8W7D635E82	The Mayor is a bit of a cheerleader. I think he does a good job, He is not shy in coming forward. I like what he has done with the Three Waters thing.	
145	X62662QKQK	I think we have a very good town which has everything we need.	
146	662BB7TCJ3	Three Waters, I was pleased and impressed that they took a stand against the Government.	
147	T84558QRTP	They don't care about what the rate payers want.	
148	6R6KE5AGH7	Take no notice.	
149	BJ4326F584	I give the Mayor a 9, he doesn't seem to muck around and gets on to things quickly. I know some people don't like him but he is the pick of the bunch.	
150	UGL6JFM7Y7	They are battling. I'm not a fan of things political - they have had troubles getting their act together regarding meeting deadlines.	
151	W2UKV68JRB	Some of the things they do, I disagree with such as spending money on the sea wall.	
152	Y6C8838W77	Lacking direction. General dissatisfaction with Revell Street.	
153	5EH446CCX7	They are wasting so much money on one way streets that people don't want. It was a trial and it's now fixed in place without further consultation.	
154	5J7V6568U3	They have got themselves off the front page of the newspapers for all the wrong reasons, which is good now as when they were on the front page, the articles were not positive.	

155	FVC3Y4G33S	I would give the Mayor a minus 1, I don't like him and lots of people think the same. He's done nothing apart from sell profit off it. He should be locked up.	
156	B2H2YR82YW	Pass.	
157	U6G75T53UA	They are doing their best in these times. The Government tells them what to do half the time.	
158	DE6N88483X	They Mayor is an 8 and 1 Councillor a 4. I like the Mayor because he is a people person but he does like to spend our money. I think he's alright but it might be time for a change.	
159	Y4T6SXN55X	I'm not a fan of the Mayor. I don't think they listen to the community. He promotes things he shouldn't. He doesn't listen to the general consensus.	
160	E82R52F8L7	I don't have a comment.	
161	P8H6A5Q4LM	They seem to waste a fair bit of money.	
162	X2ERX738UV	Not addressing the needs of the time. Wasting money on the one way system and leaking buildings. Buying stuff we don't need and doing things we don't need.	
163	2Q52T82HDR	I think they have done some strange things and haven't listened. Generally they do a good job.	
164	8X3E5NT22Y	Overspending in areas that don't need it. Just stick to the basics at the moment. The Mayor is a bit of a bully.	
165	4XH8LS6SPB	I think they are doing a good job.	
166	3347N64L6D	He seems quite involved in the community.	
167	6SX7EY86P7	I don't feel Councillors are fully supported by the Mayor and CEO in some instances. I think there is a possible conflict of interest on their personal position on gold mining within our township (Ross) which I hate. They Mayor brags me off as he is the patron of Heritage. He is adamant that he is going to see a lot of Ross mined. We have already lost a lot of our heritage sites to gold mining. I find that the Councillors, one on one are really good, they listen. Any concerns I have, I feel quite comfortable approaching some Councillors. It's not an easy job, but I do feel that the push for mining within the township is a real discredit to the community and overall residents and the future of the town.	
168	Y866Q3LE68	I like Bruce. They are spending more than they should.	

169	2V6XP654K7	I don't like the Mayor. They seem to get a bit personal with each other, they are more worried about what they are saying or doing themselves rather than the community.	
170	426C258U5E	Very slow on acting on things. Their building has sat vacant for two years, it's appalling.	
171	J4KY6P3YKD	I agree with some things and not others. Some things could have done with more consultation such as the Revell Street project. I don't think their communication has been very good with the general public lately.	
172	CDJA4B5583	They don't listen. Tourism - the towns are suffering but the Council won't take their foot off our throats. We are paying full rates. Our businesses are shut and they are still charging us. We are subsidising our tenants, they are not helping us. They don't care and they don't listen or return our calls. It's wrong.	
173	YH7YFVDJR5	Mayor 1 and Council 3. I think they forget about us down south. I think they Mayor should stop tiki touring around in his car and do his job.	
174	AWW62AQ34M	They just don't do anything that we want done. They do stuff like one way streets, spending money where it is not necessary.	
175	K534CT2H2B	Because I am very happy with what is going on.	
176	P286JRDW4W	I think they still like to spend too much money. The Mayor is proactive but there is no end in sight for spending. This needs to be reigned in a bit.	
177	4SQBVG847R	They are doing a good job.	
178	8B2HAF777F	As a ratepayer it disturbs me about the waste of money. It's our money. The Revell Street was an incredible waste of money. There has not been much consultation. It cost a terrible amount of money and our rates are horrendous.	
179	WKM64FDYKK	It's Bruce's way or no way. He is spending beyond his means. Today they just borrow borrow borrow. They have wasted money on the one way street.	
180	HLQ3E5E83V	Because I can't see how the councillors or the mayor has helped our community at all.	
181	WH84K66K5T	For one thing, I see quite a bit of spending that doesn't warrant being spent when we are supposed to be tightening our belts. One thing is Revell Street, we don't need that, it's a waste of money.	

182	53FS6EY87H	I think they have done a good job when the Government has dumped a lot on them. I think they have done good job standing up for the SNAs.	
183	2QQ6HFW3FB	They have done a lot, especially by the tip (Sunset Point). The roads are good, there are tables to sit at.	
184	NS33G7VHR6	Personally I feel the Mayor works for himself, he does what he likes to do, he doesn't listen to what the people have to say in the town.	
185	K483R3C875	The Council - we don't need half of them and they just seem to grandstand for themselves rather than fixing things.	
186	2P54MQGM4U	I don't really have much to do with that kind of stuff. I have had no issues or concerns.	
187	CJ35UW35XL	Our Mayor and Council members have tried. If we show some kindness we can have a better situation. Communication is a big thing, if this was better, there would have been a lot less nastiness.	
188	L2D2PH22VE	I don't know enough about what they have done.	
189	73EM4RJVB3	I don't really know much about the Council I don't even know who the Mayor is, I pay rates that's all.	
190	S8JCE8N2L4	They don't seem very on the same page - fractured. There is a lot going on we don't know about and the rates are going through the roof. I don't know how people can pay their rates to be honest with the cost of everything else going up.	
191	27N784YF72	They have done nothing to assist businesses struggling in the Covid environment.	
192	UJAREF753S	I don't follow it.	
193	67R33EN3J2	Don't take much notice, their trial was not a trial for Revell Street. Infuriating really.	
194	M2W4876DV2	It's a difficult job, I think the Mayor is average because he's just old school and a lot has changed since he started and I don't see him as a good representative for Westland. I'm not proud to call him our Mayor.	
195	DT28MAD2M8	The mayor is wasting tax payers money in just driving around for his own benefit of his coasters club website and Facebook page. The mayor needs to listen to the public.	
196	46C754P4NL	It is complicated. It is hard to pinpoint a reason. They do some things well and some things not so well.	

197	PAU87M336U	I think they are good at managing weather crisis events and keeping their ear to the ground but there are a lot of businesses that are suffering. Mayor is a loose canon.	
198	5N242MY7M3	I just feel that they are doing their job to the best of their ability with what they have to deal with.	
199	858455DF8Q	The Mayor gets a 1. He is more worried about himself than anyone else. The one way street, the 30k limits around town and the rising rates are the problems.	
200	PKL6V82LAQ	The Mayor is more interested in politicising himself on his Facebook page. It is perceived that he only responds to a select few. Bruce seems to say things that are not in line with Council policy and procedures. Very much a one rule for us and a one rule for them. E.g. roading requirements for different subdivisions.	
201	8Q78GWK2J7	The Mayor puts good things on the Coasters Club.	
202	TU68W437D4	The Mayor with his Coasters Club, gives a bit of exposure for local business which is fantastic. He wears his heart on his sleeve.	
203	43GWDN347K	I cannot see the point of having a Mayor and Councillors as they are controlled too much by the Government. Why can't this just be done by the CEO of the Council with input from local representatives? Our rates go up every year, well about of the CPI index.	
204	L2N2APH5X4	There are just a few roads and accessways to the beach that I feel need looking at.	
205	E25NH74J35	Because our rates are exorbitant.	
206	YB27FDA73N	They are not taking much notice of what needs to be done. Roads are going to be poor. The trucks are cutting up the roads, footpaths are not being maintained. They are doing silly things like one way streets. They are spending our money in the wrong places. Our rates have gone up hugely, it's ridiculous.	
207	3HJCND837D	I am not happy with the way the Mayor is. He treats people differently. He should treat everyone evenly. He shouldn't take sides he should be neutral and try and get the information before he forms an opinion.	
208	R26622CD56	We don't hear a lot down in Haast.	

209	G784D2BM76	The Mayor is great, he is always friendly and shows appreciation. He is fantastic and a great communicator.	
210	UJGEY57452	I think they could do a better job there is always room for improvement.	
211	2635ES2B37	They spend too much money on ridiculous things. They spend spend spend. The Mayor is rude to members of the public, he needs to grow up. Just because someone disagrees with you, there is no need to shut them down. I was told I was young and shouldn't have an opinion and that I needed legal advice before I comment. I am a business owner, he tried to scare me.	
212	BNSVGVR5H2	They are too corrupt to run a town. The Mayor got a speeding ticket and he got everyone's speeding ticket revoked on that day.	
213	4UG22H6577	They just seem to waste money and this one-way street on part of Rebel Street is the most ridiculous thing you have ever seen. It is not as if you go into a heritage area you just come into a plumbing shop and the road branches into two-way again. If there was something there it would be different but it is just a road to nowhere. It is a street that doesn't get much sun and the whole town people are not very happy with it. When it was two-way there was also parking. The plumbing shop has nowhere to drop off or pick up and it was a waste of money.	
214	5JT884783L	I think they are doing a fair job.	
215	6Q6KD7CS2Y	There is no visible improvement on infrastructure. The Mayor is poor at consulting. The Mayor has a way of saying something is going to happen that it was underway for e.g. the carpark at the Chinese gardens which was all rubbish and nothing has happened. He likes to put out good news but it's not true. He can't be believed.	
216	7EPNE68RL3	They could do more.	
217	SF7VK83VLX	They have fought hard for their district and brought in extra Government funding.	
218	XTE4DV4N67	I am fairly satisfied with what they are doing, overall things are going pretty good.	
219	PX4U2527J7	They are above average but sometimes they take on too much. It is better to do a few jobs well rather than try and take on too many and run out of time.	

220	JWG88HH5R6	The Mayor just isn't in touch which the people in the district with his grand ideas about things that are nice to have. We can't afford these things as rate payers. It's getting to the point that people can't afford to stay on their properties. We don't need the one way system which was not a trial. The rates keep going up. They don't listen. They do what they want. It seems to be ego driven. Overall I am disheartened and unhappy with our Mayor and a majority of our Councillors, I feel they have not listened.	
221	P22B484432	N/A.	
222	J3J5245PKG	They have had a lot of rows and all sorts of horrible things going on up there. When the Mayor sacks his Deputy, I think it's pretty sick. The Mayor just fires people when they go against what he wants.	
223	44C4274N37	They seem to be doing a good job.	
224	B2VV7VAC66	They do their job.	
225	R4866LMG46	I feel that the Mayor tries to promote the Westcoast as a place to visit. I think the Mayor is proactive and promotes our district.	
226	2448LYU6C4	They seem to know how to spend our money but I am not getting anything for it out here. Some more maintenance on the roads would be good on the Old Christchurch Road. They have upgraded part of it to make it wider. Two trucks can not pass on our road, it is not wide enough. They spent 3 million up here but nothing down our way.	
227	VLK4277643	The ridiculous things they are doing like the one way street and expecting everyone to sit out and dine. That great pad of concrete by the bookshop, that is ridiculous. They seem to be very slow with the erosion on the front beach, taking a long time to do anything about it. They put our rates up and spend our money on unnecessary stuff, that's how we feel.	
228	Y8VS5DP4QX	He is not frightened and gets stuck into problems.	
229	B66QWYY5A3	They get too many big ideas.	
230	8T73352N2S	He is easy to talk to. He does have our town and surroundings and interests, I can't find the word but I think he is good.	
231	MA3MNV5G6K	They seems to be a lot of infighting. They have their own personal agendas. Rates seems to be going up and nothing seems to be fixed.	

232	W2846MBGT6	They seem to do a good job but I have my doubts at times. They do the best they can.	
233	6N823PSCYD	I don't know any of them really. Some people complain and some say they are alright. Some don't like the Mayor but I don't even know him. I don't know any of them.	
234	2K5UUH3A38	I am sure there is room for improvement.	
235	K3E36JQ554	The mayor is going around promoting a page and not doing their core duties for e.g. looking after the roads, footpaths. I see the storm water drains are backed up during heavy rains.	
236	FLQ7SE3Q7W	They spend an awful lot of money in the town like doing things that aren't practical. Such as the one way system. The staff are not happy who work in the street. It was a big waste of money.	
237	34R44PR7BC	It has to be one of the most corrupt dodgy councils I have ever experienced in my 56 years. Nepotism and cronyism is extreme. They look after each other and scratch each other's backs. They keep closing down meetings and not being transparent.	
238	535236444W	Pretty much on the ball. They get a bit airy fairy at times but the locals pull them back into shape.	
239	C6XTP2S2VT	They have confused governance and management. They seem to have forgotten the role council needs to play in society.	
240	H45DR6Q7CL	It seems that they say they are going to do things and they don't happen, or they take a long time. The one way system is an abomination to be honest. We used to complain about the footpath, they are really bad for scooters for the elderly. I think they do stuff that is not necessary and don't do what is needed. They also don't fill in potholes.	
241	6JTWG57DQ7	They are putting up the rates. What we pay in rates we only get rubbish collection and there is no bus service available. The Mayor gets his old cronies into the Council. He likes to get 'yes" men around himself.	

242	N86ER5Q8N6	They seem to actually do things against what the people want. We all signed petitions about the one way street and they went ahead anyway. It has affected a business. I have not been to the shop as it is too far to walk. I can't carry paint back from the paint shop. Those business have been affected. This is ridiculous and they ignored that people didn't want it to go ahead. Most people are hot on that.	
243	Y7E4F7GX3V	There is no consultation on any subject. They do what they want. It makes no difference if you oppose anything. The Council is ruled by the Mayor. If anyone opposes him, they are pushed out. They sue people who speak up. The Mayor uses Council lawyers and has threatened to bankrupt people. The Mayor has been liquidated over 130 times apparently through the Courts. He completely and utterly wastes thousands of dollars. He spends millions of dollars of things he gets a pat on the back for with a picnic area. It's a shambles. He's as slippery as they come.	
244	F43TESSLWC	It's difficult to get good information about what is going on.	
245	B7MCC3GU75	They have not done work in our town. Hari Hari.	
246	FXJWRQGK66	They don't listen. Important issues don't get addressed.	
247	V22F86J7W7	Too early to judge as I have not lived here that long.	
248	8D6PWJ342N	The Mayor is dodgy.	
249	35APA22B6C	I haven't got any real problem with them.	
250	36D8F2U42H	From what I have read about Bruce, they seem to know what they are doing.	
251	32J3D3NDE7	They Mayor sounds good but he has wasted a lot of money. He changed a street to one way which is pointless. I'm not very happy with the Mayor, not many people are.	
252	X8KEV73H64	I don't really follow them but I don't think they really do their job.	
253	K3VH48J5G5	Allowing Revell Street one way system. They put tables and chairs on the street which won't be used for about 9 months of the year. They have put concrete in certain places and its going to be hard to access the underground services. The Councillors are weak and are "yes" men around the Mayor. The Mayor is not fit for the job and should resign.	
254	5H7T368E7Q	They went against peoples wished with Revell Street.	
255	533KA6HWM7	I am not happy with a lot of things they do.	

256	3678C7S5DJ	I have no time for the mayor whatsoever. He bought a big building that cost millions and he asked for submissions about it and he had already bought it. You just don't know what goes on. I could write a book.	
257	F5TAMAFTFM	I don't think they are doing their job very good.	
258	57BVPQ3LG5	Under the current climate with everything that is going on they are making some pretty good decisions.	
259	CT6N53CTB5	They pick up the rubbish the town seems spick and span.	
260	8W243TKGVU	They do their best and social media says a lot of things I wouldn't put up with.	
261	PU7K2T856P	Half the time they are arguing amongst themselves, not giving a proper service. Spending too much money on things that are not necessary.	
262	87M8D3Y3XA	There is room for improvement. I am happy with the way things are. I like the Christmas tree.	
263	4L27755LQV	We are getting stuff done around the town even though it is probably being paid for by central government things are getting done.	
264	6825K3434Q	They are going out and actually listening to the people.	
265	4JKD4LBAG5	Because the council has become a bloated infrastructure, overpaid overstaffed, and removed from the actual needs of the community.	
266	B8PAL2GC2E	They are not listening to public opinion and following their own agendas.	
267	4AAETXCE52	I don't pay attention to what the council does.	
268	K3753624GS	I am satisfied with what they are doing.	
269	4W2J56W854	They appear to be ok.	
270	7SBT545PMM	They have done certain things quickly and efficiently.	
271	J42P5854WQ	They bought the green stone factory which was a waste of money. They should put Revell Street back into a two way street. They are starting projects and not finishing them which is a lot of money wasted. They have cut down speed limits which is not necessary as I have lived in this town for over 70 years and it has never been a problem. They are alter things that has been good for the last fifty years.	
272	78AE8KNQH2	Our mayor gets things moving.	
273	4M38RHG62Q	They don't always listen to the people of the community that voted for them.	

274	UG7P765663	I feel they spend money on stuff that really doesn't add anything to the ratepayers.	
275	88U48N2668	Leadership? You expect the council and mayor to be providing leadership. Things like the 3 Waters have been a gut reaction - I'm not sure they are a good solution but the mayor should not be rubbishing it and talking about his share of the assets. There are a lot of problems and they are problems that are worldwide. I think the mayor is too much pro-development he seems to think the cycle trail has an infinite capacity. Before Covid there was a lot of international travellers. The council as a whole needs to be moving the public to progressive policies. Moving the town away from high erosion areas not just dropping boulders on the beach to protect the town from erosion - it is a short term measure. The glaciers are melting the sea is rising there is no doubt about it the climate is changing. The mayor and the council need to be helping people towards these difficult decisions.	
276	W8AQ5R67Y2	Our present mayor is no good and the councillors well I can't say they have done much for Westland in three years. The mayor is the biggest problem but I know he is going so. He only looks after certain people and others get left aside. He spent far too much money in this climate and that includes the old Mountain Jade building that they bought.	
277	Y73Q3CU7W6	Our mayor is very proactive and is always out there trying to do the best for the district. He has sourced so many funds from the government.	
278	V56F7D2Q3D	They are not too bad. They do need to pick up their game a wee bit. I have contacted the Council and don't have a reply, this is a year later.	
279	BRT5377RB2	I think they do a really good job of promoting the area and keeping it clean and tidy. I don't think they focus on the residents enough. We need more infrastructure on the West Coast. There is no bus service, it would be good to have a service from the out lying areas into the centre of town, even once or twice a week.	
280	2437XK4KYJ	They are wasting too much money.	
281	PENY3T2G66	I want to abstain from that.	
282	YC2R644387	The mayor seems to be on top of everything and I think he is the best man for the job.	

283	FSK7TSGQT5	I think they are trying. I think they can do better. There is money that could be spent on better things.	
284	P47N5FJRVX	They are doing their best. It is a big area from here to Haast, it is a big area to look after.	
285	7Q7LA43835	I never see them down here in Okarito.	
286	387TWJ2M8U	They are not looking after the basic things.	
287	K5JSH84Y3N	They are putting a lot of time and effort in. There have been improvements in the town.	
288	X8TPY5L4Q4	They do stuff without proper consultation.	
289	CQB8C3BW84	I really don't know what they have been doing. Everything is working alright, the roads are good and they seem to be good at their job.	
290	8UXTAV88UK	There is no consultation when spending our money and the mayor goes off on his own tangent. They seem to be spending money in the wrong areas.	
291	5MK7TD7M47	They are doing a pretty big job, it's a thankless job, they are not perfect.	
292	7S55GJ58HV	Lack of consultation on some topics.	
293	L5NNC43B46	I don't see anything amazing or terrible.	
294	JWBMH76AQ8	Too many squabbles and too much money being spent.	
295	3VV67QH5QG	They could be doing better. The rates are too high.	
296	L28C2QV6P4	I would give the Mayor a 3 and some Councillors at a 3 because I don't feel they are interested in the issues in the small rural areas.	
297	KCU5S46U5E	Totally out of control with the spending. It's not their money and they don't care that the rate payers and pensioners have to struggle with rates rises.	
298	QB5E7J77DV	Pass.	
299	22538TJ3D8	I think he has been pretty reasonable and he has some good councillors.	
300	4L5S6G66FV	Total lack of consultation with our people and the debt is rising hugely. Project going ahead with no consultation. No putting the urgent things first. This is poor management and rates are increasing. No satisfaction and no accountability. We are still waiting for an auditors report.	
301	688P4R4224	I think they do a satisfactory role, not an exemplary role.	
302	763D7YL82Y	There hasn't been a lot of controversies, they seem to be just doing the job.	

303	3NQ5V6US48	Could do better. Lose the ego. Concentrate on the basics instead of the expensive things that are for non-existent tourists.	
304	4E8KDC67TQ	They have a job to do, you can't keep everyone happy.	
305	TK5V44Q57X	The Mayor has been doing a good job. One of our Councillor members quit and has not been replaced, so we are short of representation - we are missing a vote.	
306	DDV2HT7C22	The amount of spending is too high which has put my rates up.	
307	B5CULLP7AY	Our rates are going up and they are spending beyond their means.	
308	QD3TK637P7	Pass.	
309	QLS573GN28	I don't even know who is in there.	
310	6BQ3VTVMNU	Hopeless, they do what they want. They don't liaise with the public. E.g. They bought a big building across the road, it was in poor condition, they had a report on the building and purchased it anyway. That was a disgrace.	
311	37F8SHB673	I think they Mayor could do with listening. He made Revell Street one way and built concrete seating, it's very exposed and not in the best spot. No one sits there. Lot's of the businesses are finding it hard and they have lost parking. It cost lots and he should have listened, but he didn't.	
312	G55LA65TF3	I don't have a problem with them, they are doing a good. job.	
313	FT6N23445V	They don't have much public input. I think Revell Street is a big shame and a waste of money.	
314	343E225W2S	Too much arguing but going no where fast. The Boulevard is a waste of money. No one wants to be eating with seagulls dropping on their heads at Cass Square. Absolutely hopeless. There was nothing the matter with having a two way street.	
315	7D3VG8X728	I don't like our Mayor. I feel like he spends money and I don't believe he is saving us money. What I see, I feel like we are spending more than what we should at the moment. Someone said our town looks like mutton dressed up as lamb.	
316	6323R7V86N	No opinion.	
317	6E2588HW8X	They do a good job but some areas of Westland need to be fixed up such as Hari Hari and Whataroa.	
318	H6NLEH4DGV	I think the Mayor is just promoting himself. Driving around, on Facebook and Twitter. He is doing his own thing.	

319	47H7M86N3Y	They overspend too much and rates increases. Some people are struggling.	
320	BC26P2B2Y2	They try. They don't seem to care about the rate payer.	
321	T3Y8W7A4B7	I think there has been a bit of an improvement over previous Councils. The Mayor has been a great advocate for the district.	
322	R5PYBLW726	It's a hard job. They are trying their best with what they have especially within the whole West Coast. The floods have caused problems for the Council.	
323	7L8Q227KQN	I don't see much of the Mayor.	
324	332RC574B4	They appear to do a good job but I am not convinced their morals are aligned with their stake holders. For example the development at the Racecourse is not what should be done by the Council. They are not property developers and should not get involved in that area.	
325	W8AGL24Q65	I don't think they focus too much on core jobs and they are adding sugar, rather than giving me coffee. Make sure the footpaths and water are well looked after instead of making one way streets and putting up pretty lights.	
326	7WN6EF6QR6	They are spending too much and the rates are too high. They have changed Revell Street and it's wasn't a trial and it cost too much. They are wasting money. Buying a building that wasn't worth buying as well.	
327	55V334QH5E	When Bruce Smith was elected he said he would not put up rates and they have gone up. He also said he would do a lot of things that have been put on the backburner. Unless you go to the council and seek them out we don't get a lot of news about what the council is doing. It would be nice if we got a newsletter with information about what they are doing - or what they are doing about climate change.	
328	BEE36R68LK	They are okay.	
329	22XLP75L26	I think the mayor does involve the people, he is always out in the community putting videos out. I like the way they are not too picky and get on with things.	
330	RXGE7NGN6F	Things could be done better. There is a lot of money spent for the tourism side of things including the cycle track. But the ratepayers don't use it as much as the tourists so it is a bit lopsided.	

331	RR6V368W5C	The Mayor is only out for a photo opportunity. He is useless.	
332	EKXH8Q48D3	I think the mayor is providing good leadership but the officers seem to be pre-empting policy and going ahead with government directors and regulations.	
333	8Q2HQW3NU7	They are a fail. Ongoing issues with numerous Councils that have been elected, they have had economic performances that have gone from horrific to mad. There are serious basic issues with no sign for changing. Economically they have been a disaster for years. Bruce is a bit on an autocrat.	
334	EFH878538N	There are a few things on how they spend their money that I don't agree on.	
335	546WDMFKVS	I am impressed with what is being done around our town and its environment. I could make a lot of comparisons with years gone by.	
336	282L73HFGF	They are spending money inappropriately. The one way street in particular.	
337	V658BR7F23	I like the Mayor, they are pretty good at the Council.	
338	M53YV7APJK	What is good for the town is not as important as what is good for the Mayor. As a Mayor, I thinks he does a reasonable job, just not a great job for the district.	
339	HG7T57JP7N	I don't like the Mayor, he is full of rubbish.	
340	6R84Y8YQH7	I wouldn't trust the Mayor as far as I could kick him. He would diddle people out of anything. He would take a cat to dinner!	
341	76YESW52T7	There is not very good or clear communication to rate payers.	
342	6W7D633T4E	They do the best they can.	
343	H6568442JC	They could do better.	
344	264YR7VM6W	I am not impressed with the extra things Bruce Smith has done which we are going to be paying for. Rebel Street was a waste of money.	
345	7EV5S734X5	Spending too much money on things that don't matter to me.	
346	A62R6KJA5T	He is doing the best he can I suppose but there are certain things - it doesn't matter who gets into council - you can't please everyone.	
347	36XK3J4467	I don't like our Mayor. I think he misappropriates a lot of our money. I'm not happy.	

348	WQ5ENR277V	I think some of the comments that the Mayor makes in the media are way off the mark.	
349	77YE28M733	I'm not actively involved, so I don't have any bias.	
351	P338684522	Everything seems to be running smoothly.	
352	4X36NBL46B	Because I still think there is a lot of work to be done and understanding about new environmental implications especially for farmers and other agricultural users but the council have made a good start.	
353	WPBTLAH42C	The Mayor is really good.	
354	L2J538668W	There is always room for improvement.	
355	GN3AG8WR23	The are spending money hand over fist and our rates are going up and up and we are struggling. They are spending too much to too many things on things that are not needed and we can't afford. The rates have doubled.	
356	J2WDW8LUR2	I like Bruce Smith. I find him very approachable.	
357	6KG4BGW5B8	I just think there is too much money being poured into unnecessary things such as Rebel Street.	
358	32SVGKB8P7	I think the consultation and communication has been a failure. I can see that they are trying.	
359	4HE3TK7VYL	The council has been very active and there has been a lot of progress over the last 12 months.	
360	TS8NPE3462	No.	
361	5MK2M5TDNU	I just find the mayor is not satisfactory, he spends money on his own ideas and I get the impression the councillors don't stand up to him.	
362	325NDUN472	Generally they are on track.	
363	82CWA4CV25	There are certainly things they can improve on.	
364	256AG8Y5H6	I think there is room for improvement. I think a lot of personal ideas get put through and not what is best for rate payers.	
365	7CAPDJ8M83	We only get the information we get to go by but there is always a lot of negativity from people. The council won a court case against negative information.	
69	4JAS5KYASF	Consultation is a joke. Do what they want then put the rates up accordingly. Let's look at the one way system (a joke). Start with a test budget of 50K to date spent 160K and its still a trial. Consulting means just that above as 1 example.	

110	3757SPASR8	Hard to judge as I don't go to council meetings, but read the paper and can see who says what and what they believe in.	
111	MJG8F4JV43	The Mayor's way on the highway. Only listen to ratepayers that suit him. Huge money spent on non-essentials.	
112	55SPBL7SP5	Worry about the spending and lack of consultation.	
113	3GTK5ESA84	Revell Street "upgrade" has been an expensive joke and waste of money. Rates are too expensive. The Mayor needs to actually fact check before mouthing off on Facebook.	
114	NQKM2PKP8M	They don't listen or go to ratepayers when doing alterations to streets. Revell Street - a shambles. People still go the wrong way. Poor shops along there.	
115	ACPMLUKMGU	Rate rises too high each year.	
116	JXBBW63T4W	I do not think the Mayor and team are aware of what they spend in this town and how it impacts on Council rates for years to come. The new Council building being an example of overspending before checking on expected \$ burden.	
117	35A5E3548G	The difficult situation the country is in makes it hard to operate normally but our Council is doing a good job to maintain stability in our region.	
118	7V8E3W6MS4	Generally the Mayor and Councillors have performed satisfactorily however there are times when the Mayor has expressed strong views in matters that I feel is not an expert.	
120	UP62Y7LN68	My feeling is the Mayor and Council are dysfunctional and only acting in the best interests of big businesses, mining, etc. and not the environment. I believe a lot of underhand decision-making happens, e.g., Revell Street sea wall where Council intentionally withhold or misrepresent facts, e.g., Three Waters Reform.	
121	778WAA26CB	I think they are trying their best.	
123	VXDM228U4H	Excessive rates.	

ID	RC	Q41. Do you have any comment about how Council makes decisions and engages with the community in consultation?	 Index
1	2XRMG654MU	I was a Councillor for 12 years so fully understand. Council needs to stop paying lip service to the opinions they receive through submissions but really hear and react. Get away from the attitude where they have consulted, and therefore met their statutory requirements, but don't have to listen to what is actually being said.	
2	X25A3345RD	No comment.	
3	3H82BQQKQ4	No consultation with the general public.	
4	U2224FFPK8	Community consultation must be treated as a very important matter whenever out of ordinary projects are planned e.g., Revell Street one way shambles.	
5	LW76DQBE76	I suppose every submitter wants a win, but you can't win them all. I haven't won any.	
6	8RPPR24Y7T	I wonder if some projects and consents are kept away from public eyes or only quietly put forward for consultation when they don't want a fuss. Then other projects and consents are constantly in the paper making noise for everyone to look at.	
7	P666QY85R2	They do to much behind closed doors.	
8	GVX74254L7	Those that agree with the mayor get rewarded and those that don't are pushed aside. The minister needs to step up and investigate the decisions made by this council especially around tendering.	
9	7LR78WY7B5	Need more consultation from public about decisions instead of just doing it.	
10	FDB8882NT5	They don't as I say circle of pansies.	
11	MTCU476NKE	They do not engage very well with the public before making decisions.	
12	K6P56EEH6H	No comment.	
13	H4RR2WK3J4	I don't know.	
14	54GBDSTCK2	They listen intently and then they do what they want anyway.	

15	NQJ27533B4	Councillors use Facebook pages to receive feedback which they then ignore and carry on with whatever they wanted anyway. It's too difficult to make submissions in person as you have a bunch of spin doctors making 100 page documents that the average Joe doesn't have time to digest and question before submissions are due.	
16	FS75M2K5T5	Smaller towns like ours get left out.	
17	55S8283EP8	Community meeting with people.	
18	HF23E8B8GJ	No.	
19	57Q7744356	Again, focus is not aligning with what the community as a whole will benefit from.	
20	P73DLWYA36	The public don't get the chance to have there say or just get ignored, and the general feeling is his councillors don't either.	
21	VNUSJ4AV65	With modern communication, email etc I think the ratepayers could be more involved in the decisions made on some issues like the 3 waters issue I received an email to vote what I thought should happen.	
22	6W5B6W3TVB	Would it make a difference?	
23	6PW48NAX62	As stated previously.	
24	QRHC76CTH3	I don't think council consults or engages with the community adequately, or has a good understanding of what some of the needs of the community actually are.	
25	834ELHK644	No.	
26	6YAR5TG72H	Owning a local business in commercial zone area the council tell us about decisions without consultation.	
27	PTBF52JTX5	No.	
28	825AVGB5PR	There is virtually no engagement. Executive makes the decisions, councillors are pawns and just rubber stamp with little understanding. Public can attend council meetings but can't participate. When council takes submission from the public where only a few percent participate but 97% of respondents support rejecting 3 Waters, that is not a mandate and not representative.	
31	37GJ3775R2	Well they do not always engage the community on council decisions.	
33	TH2WQ55K88	Don't listen.	

34	2383T8RB3Q	Generally the Council appears to make its decisions using the prescribed democratic processes. The Council sometimes appears to think "it knows best" when it comes to making some decisions, the Revell Street rearrangement seem to be a case in point. For Hokitika, the Council has done great work in developing the Beach Front, with further development of recreational areas (for locals and tourists alike) in the town. Again - this seems to come at the expense of less work in other towns.	
35	LBBVEH73DC	It would be good to see a more modern approach to consultation. My suggestions are online surveys and better use of the Council social media pages. Accommodate for both younger and older generations in consultation processes. Make access to public consultation pages better. Don't bring personal opinions into it. Provide the information in an unbiased format and let the public give informed feedback.	
36	65C628644P	Ultimately I think there needs to be a clearer presentation of intentions prior to projects taking place. A clearer plan of town projects and a common theme instead of the stop start piece meal approach that is happening.	
37	X6332J56L5	Need to listen to the people more.	
39	35C2553333	The council is great.	
40	54M86G63X3	Having met with and talked with people who are in community advising positions here in Westland I have formed the opinion that these informed and dedicated people would probably mark this somewhere between a 1 and 3. I am giving this a 4 because I see in the last year an improvement on public consultation - however I am not seeing an adequate reflection of the consultation results and final decisions adequately communicated. Good improvements though in last 12 months but still below average in comparison so similar councils nationwide.	
41	5384P8T83W	It's become clear recently that public consultation has no bearing on the councils decisions - it's merely a formality so they follow due process.	
42	5DUN8473FX	I actually have no idea about any of that. I'm not sure I'm aware of any engagement or consultation methods.	
43	BW23G6Y52S	I've never been consulted about anything.	

44	VH5435CYW4	No.	
45	R7658647RH	No comment.	
46	36P84B53VW	If council had to consult the community on every issue nothing would get done.	
48	8VN8L8D53M	Public consultation seems to be a formality and nothing more. Council more often appears to already have a plan in place before public consultation begins, and often take action regardless of opinion. Example - The one way Revell Street concept.	
49	3666654NN5	It doesn't work.	
50	75UK66R6MG	No.	
51	64W5L87428	Same as previous.	
52	YU2F24Q23F	Community feedback and meetings are always well advertised.	
53	P3SWVQTWUU	Again, I've not lived here long enough to get in to local issues with the council.	
54	CTCL5YBCBT	I think they generally keep the ratepayers informed.	
55	USRMSM38VW	Not really, it's mainly that I'm not interested in these things. And the things you do hear about it are often gossip in my opinion.	
56	36G43R3455	The mayor seems to dictate to the counsellors to do what he wants. If anyone of them don't agree he side lines them and treats them poorly.	
57	VB8445N866	Lots of good here.	
58	6FDJXE4GDP	No.	
59	E87LH5NUE2	One way Revell St, changed time of trial, \$ value and raiding other budgets to suit their then current decision.	
60	QTY2JPPT76	The Chinese Gardens in Ross continue to be a huge distraction for our little town. Bruce Smith told us at a meeting last year that he would take the project away from WRENIS if they didn't make significant progress by the end of the year. It's not late March and nothing has been done. We want the project back in the Community Society's control so we can get it done and move on.	
61	Q336266YNQ	The core group of voters that are loyal to the council are the only people with a voice that's listened to.	
62	A666XC43DA	They only involve who will agree with them otherwise the opinion doesn't matter.	

63	23A22P6JC4	Where there is public consultation at times public opinion is ignored.	
64	S2Y7GY6GC2	All decisions are made behind closed doors.	
65	7AECJ6CLPB	Not really.	
66	PMA6Q5Q7XW	We're pretty good here.	
67	WS6CSX32Q4	No.	
68	R3X24YR7Q2	A bit more open consultation with the rate payers would be beneficial, I understand you cannot please everyone.	
70	J2W528644C	Didn't know public were involved.	
71	UFK8ACBNBG	Not enough public consultation.	
74	B5JNC2UM87	Regarding 99% of decision they don't get public involved in decisions.	
75	3YJ7F6MVSF	Decisions are never going to satisfy all. Things are becoming too "PC" for me. People I vote for I trust to get the job done. Too much consultation.	
76	8S22F78CX3	They engage, then ignore.	
78	3L37MQ3J26	Nothing regular in encouraging participation. Generally a case of "it will be, as I say".	
82	R52SAB6L4H	The Council makes the decisions and then engages with the community.	
85	T22BQ7D3N8	No.	
86	4275JK5777	As previous.	
90	AHL3R2QFJ6	Yes. Local public meeting venues work well, for instance, local school, local hall. This way more old people attend.	
91	F58EP6T55W	Very little or no public consultation.	
93	H5CRN8B7GM	They are open to submission and public feedback but how many Councillors and the Mayor have a vision and forward thinking as to where we want to be in 10 years time.	
95	U3D5DBC48M	I feel once set on ideas, that's it. When communities hold a petition against Council, it still carries on.	
98	US7V7A5822	It is amazing the mayor got voted in and half the councilors do the job. How do you think this board council works. They don't listen or understand the people.	
99	ETL3AD4E5J	Never have been consulted.	
102	6T5FUTUW6A	Some decisions that should have had public consultation did not.	
103	JH3MK5S3P2	Yes, not enough.	
104	66867BWNWM	Could be a little better at communication.	

105	45E734TNM3	Think Council & Mayor just pay lip service to the community.	
106	A8B83P8VS8	As pointed out in question 38, much of the important decisions making has fallen in the hands of the Holding Company & Destination Westland. Councillor & Mayor should be making those important decisions on our behalf.	
124	LQ7G3766CV	Not involving rate payer in final decisions.	
125	U7BU3K4CB5	I need to go to one of their meetings.	
126	6274MWB7N2	I think a lot of the big decision need to be more publicly aired first.	
127	7RLRWB7TC4	From the people I interact with, the public feeling is very much bad about what the Council has done, costing heaps when they said it wouldn't. They won't disclose this information. They have put our rates up heaps. This was non-essential work we didn't ask for, didn't want and don't like but we are now paying for it. They said they money has come from other accounts. They are not being transparent. Disclose these costs please. Original limit was 50K - it was miles above that, but we don't know how much.	
128	7BTPY766AV	They put in a one-way road without consulting us. We weren't consulted and are not happy.	
129	5SG6RK6A7V	They are ticking along well.	
130	3QJ5765K85	Said enough.	
131	VB7BP2867S	Pass.	
132	VPV6WSQJ2E	I don't have a lot to do with them, but I don't think they consult very well.	
133	588EMC6GSB	When they put in the one-way system, it was a trial and before anyone knew it, they were making it permanent but with consultation. A lot of the businesses were unhappy. Changing the parking to parallel parks was a waste of money and we aren't getting information until the results are already out.	
134	SK7L58GX5M	They didn't let us know anything about the street. Our rates are really high and have gone quite considerable recently.	
135	52A4K3X883	They don't consult the public enough.	
136	PM83823Q2B	I feel like they do involve us as much as they can.	
137	456C72N8TN	They try their best but they are not helped by the Mayor. He allows personal decisions to interfere.	

138	RAYC44BCYK	There are several things, like Revell Street. They actually put it into practice before anything permanent was done.	
139	2EH4T6A26C	The one way street was not properly consulted on.	
140	WV2J8J2HSV	Most of them are trying and it's not an easy job. I think they spend too much money and the debt is too high for the size of the town.	
141	57HB4847V2	The people have their say and the Council have total disregard for public feedback. I believe some of the Councillors are there for their own personal/political gains just to be seen.	
142	GV456A27S2	Sometimes they don't listen at all they have already made up their mind.	
143	6C4857423N	They consult the public and then do what they want. They are not really listening to us.	
144	8W7D635E82	I think they involve people sometimes too much. Why bother asking when you already know the answer.	
145	X62662QKQK	We have a local paper that reports on the council and the council informs us that way.	
146	662BB7TCJ3	They do consult with newsletters, they try.	
147	T84558QRTP	Our rates are going through the roof and the council keeps chucking our money where we don't want it for e.g. Revell Street.	
148	6R6KE5AGH7	No interest.	
149	BJ4326F584	Not quite sure about the process. They should communicate better with us.	
150	UGL6JFM7Y7	They do a reasonable job.	
151	W2UKV68JRB	Pass.	
152	Y6C8838W77	Pass.	
153	5EH446CCX7	You don't see anyone and don't know what they are. A bit like Parliament.	
154	5J7V6568U3	I think they are very good at doing that.	
155	FVC3Y4G33S	He does not involve the public. He is very corrupt and people are suffering because of him.	
156	B2H2YR82YW	Pass.	
157	U6G75T53UA	They should consult more than they currently do.	
158	DE6N88483X	They had a change to a one way street, there was a petition and they went ahead and did it anyway. We are not happy, they didn't listen us.	

159	Y4T6SXN55X	We get the paper and I never see anything that clearly sets out they are looking for submissions. I don't feel they are open about how they operate.	
160	E82R52F8L7	No.	
161	P8H6A5Q4LM	I don't believe they really do a lot to engage the public. They just go ahead and bloody do things.	
162	X2ERX738UV	It's Bruce's way or the other way. I can remember the last time the public got involved. Discussion was sort for the one way system, we didn't want it but it went ahead anyway.	
163	2Q52T82HDR	I think they are pretty up front with that. It's all about listening to what we say. Sometimes local people are critical.	
164	8X3E5NT22Y	I think that if people have a complaint they need to address it. I don't think they always take notice of peoples voices.	
165	4XH8LS6SPB	Some things are good at such as involving the public. Revell Street, they didn't really listen and it upset the town folk.	
166	3347N64L6D	No.	
167	6SX7EY86P7	There is not a lot of decisive open consultation or consideration of submissions that people put in. A bit of overriding from the Mayor.	
168	Y866Q3LE68	I'm not happy. They made a one way street which was supposed to be temporary. It's never going back to a two way street.	
169	2V6XP654K7	We get some information on long term plans.	
170	426C258U5E	It takes soo long to make any decisions.	
171	J4KY6P3YKD	They need to consult more.	
172	CDJA4B5583	Don't listen to the public. They do what they want. The Wild Foods Festival - they don't have a cent to rub together after years of running that festival. They don't even own a marquee or stage. Where does the money go? It's now farmed out to private people.	
173	YH7YFVDJR5	They don't listen. We get forgotten. We have not had our footpaths fixed in 10 years. They talk and don't do. About 18 months ago they brought us a plan of what they were going to do with our footpaths and it still hasn't been done. The footpaths are disgusting. They are dangerous.	
174	AWW62AQ34M	There is no real consultation.	

175	K534CT2H2B	I am reasonably happy, they keep the public advised through the news media, the papers.	
176	P286JRDW4W	They pay lip service to the Revel Street. It was always going to happen. They made it sound like a trial. They did things without our opinions.	
177	4SQBVG847R	They seem to be pretty clear in their consultation.	
178	8B2HAF777F	At times there seems to be infighting in relation to everything, including consultation. They are not working for greater good. There are some outstanding Councillors [REDACTED] is one who goes over and above the call of duty. He puts his whole heart into our town. I hope he stands for Mayor next time.	
179	WKM64FDYKK	They don't listen - Bruce always gets his own way. I don't think the Councillors have any say.	
180	HLQ3E5E83V	No.	
181	WH84K66K5T	They do lots of things without consulting the public. The Revell Street mess was one of those. The protection on the sea wall was another.	
182	53FS6EY87H	There is still a lot that goes on behind closed doors that we want to know more about.	
183	2QQ6HFW3FB	They made a one way street and lots of people were against it. They asked, we said no and they did it anyway.	
184	NS33G7VHR6	I don't feel they involve the people enough.	
185	K483R3C875	No they take your money and forget about us.	
186	2P54MQGM4U	They seem good.	
187	CJ35UW35XL	If the communication was more positive and more embracing I think they would have better resource pulling in the community.	
188	L2D2PH22VE	No.	
189	73EM4RJV3	I think they do a reasonable job with the finances they have.	
190	S8JCE8N2L4	Once again it seems pretty fractured and if there is engagement they don't seem to listen anyway - the same as the government.	
191	27N784YF72	They don't listen to public feedback or submissions.	
193	67R33EN3J2	They don't consult you when they make changes, e.g. Revell Street. The only people can turn up are people who have nothing better to do.	
194	M2W4876DV2	They could communicate better, especially in the age we are in now with the internet.	

195	DT28MAD2M8	They should listen to the public when they put in submissions. Read the letters to the editor in the local paper with an open mind. Revell Street needs to be a two way street.	
196	46C754P4NL	Not really.	
197	PAU87M336U	Their community consultation is token. They should learn more about community development and getting people on side.	
198	5N242MY7M3	I am happy with that. We have had two public meetings in the town hall put up for the public to get involved and I am happy with its transparency.	
199	858455DF8Q	That one way street, they just did it. Everyone was pissed off. Plus the 30K limits around town.	
200	PKL6V82LAQ	When asking for feedback on lowering speed limits. We put in our reasoning for having it lowered, every other application was grated apart from our one. The roading engineer from the Council was horrified. It's currently 100kmph, the roading engineer wanted it to be 30kmph. It's still 100kmph. It's a racing track and very dangerous.	
201	8Q78GWK2J7	Not sure.	
203	43GWDN347K	I think they have an agenda. They pick and choose what they want to run with despite appearing to consult the public.	
204	L2N2APH5X4	No.	
205	E25NH74J35	They have lots of consultation but they don't listen.	
206	YB27FDA73N	You can put submissions in but I don't think they listen to you. They need to listen to the people more.	
207	3HJCND837D	Yes, they have in the past treated applications differently.	
208	R26622CD56	It's just a general way I feel.	
209	G784D2BM76	Submissions are requested, no matter how hard we try, the decision has been made. Why bother, they don't hear us. That's why we are frustrated.	
210	UJGEY57452	I think they could engage a lot more. Have meetings in each area not just some areas.	
211	2635ES2B37	They don't like to involve the public. The one way street was a joke. Lots of people aren't happy. They just run with what they feel is right, no matter the opposition, they do what they want. The outrage from people was more against than for.	
212	BNSVGR5H2	They don't listen to what the people want.	

213	4UG22H6577	I have never heard them ask the community opinion about anything.	
214	5JT884783L	No comments.	
215	6Q6KD7CS2Y	I think the consultation is poor and we find out what is happening when it is underway.	
216	7EPNE68RL3	No.	
217	SF7VK83VLX	They have open communication with community groups. The community groups communicate with the community.	
218	XTE4DV4N67	Not really no.	
219	PX4U2527J7	They seem to be trying to be open and they are doing the online thing so people can watch it so that is good. Some of the decisions I think everybody would question you can't please everyone.	
220	JWG88HH5R6	They don't listen. They ask for feedback and ignore it and charge on with whatever they want to do anyway.	
221	P22B484432	No.	
222	J3J5245PKG	They are doing things without consulting. E.g. picnic tables on a shady side of the street. The one way street was supposed to be temporary, they are spending money we don't have on things we don't need or want.	
223	44C4274N37	It is very satisfactory.	
224	B2VV7VAC66	NA.	
225	R4866LMG46	I am happy with it.	
226	2448LYU6C4	We don't get a lot of notification really. We just get told after things are done.	
227	VLK4277643	I think they could do better.	
228	Y8VS5DP4QX	No.	
229	B66QWYY5A3	I think we have our lady who is fighting a court order who is doing a lot on our behalf. Things could be more out in the open. There is a lot of horrible letters in the paper. Everyone wants to join in the fray. It makes me feel uncomfortable. I'm a softie.	
230	8T73352N2S	No.	
231	MA3MVV5G6K	It seems like a secret society and so people don't seem to engage with them anymore.	
232	W2846MBGT6	They advertise the meetings, so I think that is reasonable.	
233	6N823PSCYD	I know a lot of people complain that the lawns outside are too long.	

234	2K5UUH3A38	There could always be more consultation.	
235	K3E36JQ554	They don't engage with the community. When they have a meeting its behind closed doors and we never get to know what is happening.	
236	FLQ7SE3Q7W	Every now and then they will ask us. Despite any objections they do what they want anyway.	
237	34R44PR7BC	Some of them try to engage with the community but overall every time a big decision is being made they shut the meeting down so the public or the media don't get involved and it goes on too often behind closed doors. Open and transparent is what we want.	
238	535236444W	They can be a bit in-house at times.	
239	C6XTP2S2VT	Council makes decisions without having the mandate. They do what they want without consulting the public.	
240	H45DR6Q7CL	N/A.	
241	6JTWG57DQ7	They need to be more transparent before they make certain decisions.	
242	N86ER5Q8N6	They don't consult the locals and if they do, they do their own thing.	
243	Y7E4F7GX3V	I wouldn't hold any member of the council responsible. If they don't play ball they are gone. They are fired, out the door and gone. The Mayor makes peoples lives so uncomfortable. He has five cronies, he always gets the majority. It's no use standing up because you won't win.	
244	F43TESSLWC	They have adopted policy of informing people rather than consulting people. We get information, not consultation.	
245	B7MCC3GU75	I don't think we get enough of the right information.	
246	FXJWRQGK66	Revell Street was ridiculous. It was not supposed to be temporary but it is now permanent. It's ruined the flow of town. The wooden tables are horrible and elderly people would struggle to use them. The biggest table is on an angle. They then planted weeds. some grasses, they are terrible. I don't know if some people have changed them, just weeds.	
247	V22F86J7W7	Seems like they are doing the right thing.	
248	8D6PWJ342N	At the end of the day, they do what they want.	
249	35APA22B6C	They don't listen to you.	
250	36D8F2U42H	I think they should make more face to face contact. Be a bit more open with their meetings. Bring subjects up in the papers.	

251	32J3D3NDE7	They Mayor tells everyone what to do. He says he doesn't, but he does. Like ducks behind a mother.	
252	X8KEV73H64	We tried to get a better park. They didn't listen to us.	
253	K3VH48J5G5	They do what they want and never listen to the public for e.g. Revell Street.	
254	5H7T368E7Q	They often decide between themselves.	
255	533KA6HWM7	A lot of things they do I don't like. Some of the things they ask they public about and just do. Like the wrong way street.	
256	3678C7S5DJ	No.	
257	F5TAMAFTFM	No.	
258	57BVPQ3LG5	As a ratepayer I don't often receive a lot of notification about upcoming decisions and meetings. A little bit more inclusiveness for the ratepayer. It is not until you read the local paper you find things out. I have a right to know as a ratepayer.	
259	CT6N53CTB5	I don't know. I have only been here a year.	
260	8W243TKGVU	They seem to do a reasonable job within the constraints being handed to them from up there.	
261	PU7K2T856P	Rebel Street one-way is the main problem. Nobody wanted the thing except the council. If they had consulted on it properly it never would have happened.	
262	87M8D3Y3XA	I'm not even aware being able to make decisions.	
263	4L27755LQV	No.	
264	6825K3434Q	We have good consultation and they go out and listen to the public.	
265	4JKD4LBAG5	They pay lip service to consultation but then they just do what they want. They have a lot of closed-door meetings and are very dismissive of the public.	
266	B8PAL2GC2E	No.	
267	4AAETXCE52	It's nice the council asks for feedback if only they do something with it.	
268	K3753624GS	No.	
269	4W2J56W854	No.	
270	7SBT545PMM	They don't listen to any community feedback.	
271	J42P5854WQ	They should be consulting with the community more. They are only a small group of people who are making all the decisions.	

272	78AE8KNQH2	When council is making decisions they do invite the public.	
273	4M38RHG62Q	Don't know.	
274	UG7P765663	Yes, on some things they consult but on other issues, even when it is pointed out to them that it may be too expensive, they continue to do what they wanted to do.	
275	88U48N2668	I think again my chief difficulty is that we have diligent council officers that put everything into simple questions and there isn't enough chance for left-field alternatives. It is rather stayed. I can understand how it happens as you end up with a list of questions that no one can answer but it is the problem with all public consultation things get simplified.	
276	W8AQ5R67Y2	No.	
277	Y73Q3CU7W6	They are pretty good and when you pick up the paper you get all the information required.	
278	V56F7D2Q3D	They do put a lot on Facebook about what they are up to.	
279	BRT5377RB2	I don't tend to get papers, therefore I don't feel I get enough information.	
280	2437XK4KYJ	They don't listen.	
281	PENY3T2G66	I don't want to answer that question either thanks.	
282	YC2R644387	No.	
283	FSK7TSGQT5	They sent a questionnaire that was not accessible, that was a complete waste of money. There is too much wastage.	
284	P47N5FJRVX	No.	
285	7Q7LA43835	Pass.	
286	387TWJ2M8U	They don't listen to the public for e.g. Revell Street. There is no parking on the street and it becomes difficult for the courier drivers.	
287	K5JSH84Y3N	There is a couple of things that could have been better consulted on such as the one way street. They could have been more forthcoming.	
288	X8TPY5L4Q4	No.	
289	CQB8C3BW84	No.	
290	8UXTAV88UK	A lack of consultation with the community.	
291	5MK7TD7M47	There could be a lot more public involvement with some issues. You find out about stuff after it has happened.	
292	7S55GJ58HV	I think they have to be a bit more careful on topics that needs consultation. I don't think they need to consult us on everything.	

293	L5NNC43B46	They could make sure their information reaches more people. Their decision making is alright.	
294	JWBMH76AQ8	They are making the wrong decisions. I am not satisfied with their outcomes. They are spending money in the wrong areas.	
295	3VV67QH5QG	When you look at Revell Street, they didn't listen to us.	
296	L28C2QV6P4	I don't think there is enough consultation over the smaller matters.	
297	KCU5S46U5E	They don't consult with the public. They've spend over \$500,000 doing a one way street without consultation. People aren't happy.	
298	QB5E7J77DV	They have gone ahead with things that they haven't consulted the public on such as land in Opuapua.	
299	22538TJ3D8	No, I think if anyone wants to turn up to the council meeting I think most meetings are open to the public - not all the time, but a lot of the time.	
300	4L5S6G66FV	We get threats put on us for bankruptcy through the courts too, their communication is shocking. The Mayor is overpowering and this takes away the rate payers voice. The staff are reluctant to say much because they are looking after their jobs. They are putting more assets over to the Council companies, it's like it is an employment centre. We say reduce that debt. It's top-heavy in administration.	
301	688P4R4224	I don't think it always has open meetings - I think they have closed door meetings the public could be interested in.	
302	763D7YL82Y	I have been part of a community group where we have done formal consultation and I have found the process okay.	
303	3NQ5V6US48	They could be more open in their decision making and less exclusive.	
304	4E8KDC67TQ	N/a.	
305	TK5V44Q57X	I think it's very poor. The only thing they Mayor and Councillors are interested in is getting votes. There is so much going on that could be done better but they don't, as they don't get votes from it.	
306	DDV2HT7C22	They don't listen, I don't think they take everything on board. The speed limit changes, I disagreed with them and no one listened.	
307	B5CULLP7AY	Things happen without consultation and before you know it's in place.	
309	QLS573GN28	I think it's alright.	

310	6BQ3VTVMNU	The one way street was the biggest shambles under the sun. Trucks can't park there to unload stock for shops. It's another whim for the Council for what they want. It's disgusting.	
311	37F8SHB673	They have a lot of closed meetings and people say the decision has already been made.	
312	G55LA65TF3	There is good consultation with the public.	
313	FT6N23445V	They promise one thing and don't always stick to it.	
314	343E225W2S	The business with one woman in town has been disgusting. She does not seem to be able to get her position across without being threated with lawyers. We shouldn't have to pay for this sort of dispute. Bruce should pay his own legal costs.	
315	7D3VG8X728	I got involved once and got no feedback. I haven't got involved with anything since.	
316	6323R7V86N	I think they do their best.	
317	6E2588HW8X	Pass.	
318	H6NLEH4DGV	They don't listen to what the rate payers are saying. They are doing their own thing.	
319	47H7M86N3Y	They have done things, I know some people have been dissatisfied. Revell Street. This affects businesses.	
320	BC26P2B2Y2	They don't get involved. We can make all the submissions we like, things still go ahead. Revell Street was a big problem.	
321	T3Y8W7A4B7	I know they publish long term plans and pages of small print. I suppose lots of people like me are guilty and not that engaged.	
322	R5PYBLW726	Most of the time they seem to inform the public but there is the odd time when they don't communicate with the public.	
323	7L8Q227KQN	It's fine.	
324	332RC574B4	They don't involve the public, e.g., Revell Street. It wasn't supported and they still went ahead with it.	
325	W8AGL24Q65	I have heard negative feedback from people, they are obviously not doing something right such as listening.	
326	7WN6EF6QR6	They don't consult. They say they are listening but they aren't listening.	

327	55V334QH5E	I think they should be more open and transparent about what they are doing and send out a newsletter that says in detail what they have been doing. There is not enough information about the day to day running of the council and what they are doing.	
328	BEE36R68LK	When the Council does something it's more for Franz than Fox. I like Bruce.	
329	22XLP75L26	We are allowed to be involved if we want to be.	
330	RXGE7NGN6F	I can't understand why they have to have so many on the committee, overheads wouldn't be so high.	
331	RR6V368W5C	They ask for submissions and go ahead with projects anyway.	
332	EKXH8Q48D3	No.	
333	8Q2HQW3NU7	The tail wags the dog. The economic performance has gone from poor to bad. The opportunity for people to bring issues to the table is now not a going scene. Decisions are being taken despite being opposed by the community. They have become a law unto themselves.	
334	EFH878538N	I think they could talk to the public a bit more.	
335	546WDMFKVS	No, the primary responsibility lies with the people themselves to keep informed and keep in touch.	
336	282L73HFGF	I don't feel they involve us enough or listen to the public.	
337	V658BR7F23	People's requests don't get actioned.	
338	M53YV7APJK	The Council here, the faults lie 5 and 6 Councils back. They went from having money to being bankrupt. They were run rings around by a previous CEO, I think that's where missing money went. The current Council and the previous one have inherited lots of problems from previous councils. They don't involve the public in decision making, there is no consultation. They are reviewing a speed system, why spend that money?	
339	HG7T57JP7N	They say a lot, ask a lot and then do their own thing.	
340	6R84Y8YQH7	I don't get the paper anymore as tourists used to take it. I gave up and cancelled my subscription. I don't get the information unless I go to the library. I am not impressed. Bruce Smith is only interested in feathering his own nest. Some of the Councillors are genuine. I wouldn't trust Bruce as far as I could kick them. He's a nasty piece of work.	

341	76YESW52T7	They don't engage with the public.	
342	6W7D633T4E	They don't involve the public enough. They could be clearer where the money is spent.	
343	H6568442JC	The could notify us better.	
344	264YR7VM6W	No.	
345	7EV5S734X5	No.	
346	A62R6KJA5T	No.	
347	36XK3J4467	It's because they made a proposal in the last year to make a street one way and a lot of the public said NO. For me it was about the cost. It became a real fiasco and they just went ahead and did it anyway. This was unacceptable.	
348	WQ5ENR277V	It's hard to get the public involved, people like to throw stones from the outside.	
349	77YE28M733	I know they have regular meetings but I'm not sure otherwise. I don't see any notices in the community.	
351	P338684522	I feel like I get regular information if I want it. They have a good social media presence.	
352	4X36NBL46B	Only to say that sometimes I think the consultation service is lip service only. Sometimes I don't think the consultation with the community is taken into consideration but I do acknowledge that they do make an effort to consult with the community.	
353	WPBTLAH42C	They don't take of lot of peoples feedback into consideration.	
354	L2J538668W	They could be more forthcoming before making decisions.	
355	GN3AG8WR23	Totally disgusted with the Council. I know what is going on, lots of bullying. If you question anything you get shut down. I know a couple of people who sent letters to the papers. The Council just does what they want. They don't ask us. The Mayor loves to spend money and it's our money.	
356	J2WDW8LUR2	I think they do a good job.	
357	6KG4BGW5B8	I don't think there is enough consultation about some of the things that are done.	
358	32SVGKB8P7	There is a lot that goes on behind closed doors.	
359	4HE3TK7VYL	Yes, I do. More communication with the ratepayers.	

360	TS8NPE3462	No.	
361	5MK2M5TDNU	Sometimes they consult but not always.	
362	325NDUN472	I think there are plenty of opportunities if you want to but not many people do.	
363	82CWA4CV25	No.	
364	256AG8Y5H6	Revell Street, they did not listen to what the rate payers were saying. There were petitions but they did what they wanted.	
365	7CAPDJ8M83	No.	
110	3757SPASR8	Get the feeling that engaging with the community is a tick box exercise and there is already a plan that will go ahead anyway.	
111	MJG8F4JV43	Read last comment.	
112	55SPBL7SP5	The Council consults but does not listen to what people are saying.	
113	3GTK5ESA84	Listen to the community. Don't have pre-conceived decisions/ideas. Do surveys about things that matter to us. Fix things that are actually broken, not mess with things that are okay.	
114	NQKM2PKP8M	Most of the time no one knows what's happening till it's on paper.	
115	ACPMLUKMGU	No.	
116	JXBBW63T4W	People did not like the one-way street at Stella Cafe but Council went ahead with it anyway! There's an example! Not enough consideration for on-going costs, e.g., \$2-\$3 million to bring up to standard? - for the new Council building recently purchased?	
117	35A5E3548G	More consultation would improve decision-making and lessen speculative rumours.	
120	UP62Y7LN68	See previous comment.	
121	778WAA26CB	No.	
123	VXDM228U4H	Not well-informed about unnecessary spending.	

ID	RC	Q43. Could you please tell us why you feel that way? - Public safety	
1	2XRMG654MU	Good services, good people.	Index
2	X25A3345RD	Don't know.	
3	3H82BQQKQ4	People can still leave their doors unlocked.	
4	U2224FFPK8	Great township with friendly residents. Tidy town when reserve/road maintenance work is kept up to standard - as of five or so years ago!!!	
5	LW76DQBE76	This question is mandatory.	
6	8RPPR24Y7T	There has been several times now where communities are left with no way of making contact in an emergency. Many of us live great distances from medical services and having no way of contacting them is scary.	
7	P666QY85R2	The people are honest and we are far away from the rabble of society.	
8	GVX74254L7	No police after 10pm most nights.	
9	7LR78WY7B5	Some dodgy people around but good for the most part.	
10	FDB8882NT5	I like living here lived here all my life.	
11	MTCU476NKE	The number of people here means there is community look out for each other.	
12	K6P56EEH6H	No comment.	
13	H4RR2WK3J4	I live in the middle of nowhere.	
14	54GBDSTCK2	Where we are everyone still leaves the keys in their cars and houses unlocked.	
15	NQJ27533B4	Police and community patrols are non existent during night time. Seaview is a great example where ratepayers have formed their own watch groups to look after the area.	
16	FS75M2K5T5	We don't feel threatened by anything.	
17	55S8283EP8	I don't feel threatened.	
18	HF23E8B8GJ	Compared to the other towns in the area I would say yes.	
19	57Q7744356	Police presence at night is definitely not reliable.	
20	P73DLWYA36	Very peaceful friendly people.	
21	VNUSJ4AV65	99% of the time its great but there is always that 1%.	
22	6W5B6W3TVB	We don't have too many scum bags here at the moment in Hokitika.	
23	6PW48NAX62	Footpaths are not that safe otherwise I have no complaint.	
24	QRHC76CTH3	Mainly because there is very little crime here.	
25	834ELHK644	No.	

26	6YAR5TG72H	I would feel safe if I had to walk around Hokitika at night. The local people know each other and are helpful in any situation.	
27	PTBF52JTX5	Relaxed and friendly people.	
30	3KE5FH3P76	I've never felt unsafe and the neighbourhoods are friendly.	
31	37GJ3775R2	Just feel that way.	
32	6D48LD2S7S	It's home.	
33	TH2WQ55K88	Because it is.	
34	2383T8RB3Q	Presently gang presence and meths use appear to be at the lower end of the scale. Theft is also at the lower end presently. Communities are caring and residents generally keep an eye out for each other. Health care provision is adequate and police presence is also adequate and responsive when necessary.	
35	LBBVEH73DC	Friendly neighbours. People pull over to help you change a tire. Amazing community groups/clubs.	
36	65C628644P	We are lucky to live very freely with minimal crime. A great safe place for children and elderly. A great sense of community.	
37	X6332J56L5	Good community awareness and support.	
38	64VAT555WP	Small population. Community. Neighbours looking out for each other.	
39	35C2553333	It's a great place.	
40	54M86G63X3	We have a higher proportion of gangs, drug producers and suppliers, violent offenders and paedophiles than I would have hoped for in such a small community (many who are popping in and out of our community from other places like Greymouth). It's something we all have to contribute to keeping an eye on and resolving. Not the councils fault or responsibility - but promoting a bit more support for proactivity from justice services could be a stronger focus for the council - and communicating positive outcomes would help everyone. Let's stop pretending it doesn't happen here!	
41	5384P8T83W	Crime levels appear to be lower than other areas in the country. Roothing is well maintained.	
42	5DUN8473FX	The district itself is friendly and mostly well presented. The safety that I have the most concern with is the roading condition and maintenance.	

43	BW23G6Y52S	Roads - they need to be improved with better surfacing for safety. Emergency services should have a better response time for the rural area. Rural areas should be provided with waste and recycling services.	
44	VH5435CYW4	It's like New Zealand was years ago.	
45	R7658647RH	No break ins or car thefts, like family members have experienced in Christchurch.	
46	36P84B53VW	Every community has its criminals and thugs but Westland has probably less than more urban areas.	
48	8VN8L8D53M	I moved here for my family, because I want them to grow up in a small community. People know each other, and they look out for each other. I am grateful to be part of this community.	
49	3666654NN5	Not sure.	
50	75UK66R6MG	Live in a rural area and we have no issues with the area or the surroundings of where I live.	
51	64W5L87428	We have psycho twins living next door to us who have a lot of police activity.	
52	YU2F24Q23F	Low crime rates.	
53	P3SWVQTWUU	The feeling of community is such that I feel if anyone was feeling unsafe, someone would help immediately.	
54	CTCL5YBCBT	The policing appears to be adequate.	
55	USRMSM38VW	Coming from a big city in Europe this is the safest place I've ever lived in my life. So far nothing has happened even when we forget to lock our doors. It's truly amazing!	
56	36G43R3455	The police seem to keep a good watch over things.	
57	VB8445N866	Lots of great people caring for our people, kids can ride bikes freely, go to the dairy to get un supervised, jump off the bridge. You can't plan that stuff in can you.	
58	6FDJXE4GDP	No issues.	
59	E87LH5NUE2	Rural seems safe enough.	
60	QTY2JPPT76	Compared to any other part of the country --- this has to be the safest.	
61	Q336266YNQ	Riff raff are making a line for the small towns. Government policy makes it hard to get rid of the bad eggs.	

62	A666XC43DA	Mostly safe yes but more could be done for better sidewalks and more street lighting well better lighting.	
63	23A22P6JC4	Low crime, great community.	
64	S2Y7GY6GC2	Being a small community people living here keep an eye out on their neighbourhood and tend to see when things a not as they should be.	
65	7AECJ6CLPB	In the Hokitika area there seems to be a great regard for the older population. Even the teenagers seem to have respect for us.	
66	PMA6Q5Q7XW	We still look out for each other in the community. The bike tracks allow kids to get around off road. Mostly people are pretty polite.	
67	WS6CSX32Q4	I feel very safe here, but only takes one to change feeling of safety in the community at any time.	
68	R3X24YR7Q2	Common sense should be used more often.	
70	J2W528644C	Things can still happen.	
72	3TJLD43C8W	We don't have a lot of crime here.	
74	B5JNC2UM87	Not a lot of crime that we hear about. Small community & people do look out for each other.	
75	3YJ7F6MVSF	I feel safe here. A few "nasties" around - but it is the same all over the country. Drug related crime does concern me.	
76	8S22F78CX3	No major crime.	
77	VL6D76V6X3	It is not as safe as it used to be, but that is probably just a sign of the times.	
78	3L37MQ3J26	We have some good volunteers for behaviour patrols. Things are usually quite orderly, but perhaps drug infested.	
80	5UGX3A3K2B	I feel quite safe.	
82	R52SAB6L4H	We feel safe here in Kowhitirangi.	
85	T22BQ7D3N8	Recent imports have changed the Coast a lot.	
86	4275JK5777	Bruce hasn't upset Putin.	
88	876F2CB5K7	Water issues, e.g. water often cut off. Drains not great after rain fall, leaves from gardens blocking drains.	
90	AHL3R2QFJ6	The police presence is appreciated in rural places.	
91	F58EP6T55W	Very clean and safe town.	
95	U3D5DBC48M	Every town has a small rough element.	
96	435XJ8MA3Q	Been a victim once.	

97	HG6F35S4X5	Footpaths and lighting are not maintained to ensure safety of elderly members of our community.	
98	US7V7A5822	Everyone in this district cares.	
99	ETL3AD4E5J	Low crime. Everyone is friendly.	
100	8F5658NRTP	Crime Low.	
102	6T5FUTUW6A	Depends on locality. To me, most problems arise, criminals, drug addicts or mental patients move in from larger centre to our district.	
103	JH3MK5S3P2	We need more cameras in town, no matter the cost.	
104	66867BWNWM	Gangs are really becoming an issue.	
105	45E734TNM3	Personally, I never had an issue.	
106	A8B83P8VS8	I have no reason to think it is not a safe place to live.	
124	LQ7G3766CV	Not as much crime or anything around here as against other places.	
125	U7BU3K4CB5	I can send kids to the park, would not go to town on own at night.	
126	6274MWB7N2	I think we haven't had any issues. It is welcoming in town, people are great.	
127	7RLRWB7TC4	I think the police have given up on cannabis and tiny houses. They should be backing up the law. I think a lot of the crime has come from immigrants to the area.	
128	7BTPY766AV	Good community and I feel safe leaving my property unlocked. Someone is always willing to help.	
129	5SG6RK6A7V	We have been pretty lucky, I can drive and see no one. It's paradise.	
130	3QJ5765K85	I think it's because of they type of people who live here and our lifestyle.	
131	VB7BP2867S	From a flooding perspective, not safe. It's pretty isolated, so if you need the cops in a hurry they take a day to get there. I don't feel safe if there are medical issues.	
132	VPV6WSQJ2E	No specific reason.	
133	588EMC6GSB	It's always been a good place to be but we are now a drop in centre for emergency housing with more gangs moving into the area which changes things a little bit. Two motels in the area are being used for emergency housing and we are having people just out of jail and gangs sent here. There has been a few skirmishes as the hotels. There have been more break ins recently.	
134	SK7L58GX5M	I've had no problems.	

135	52A4K3X883	The police could do a better job with the unsavoury people in our district. Apparently they are rehoming criminals in the area which is not good.	
136	PM83823Q2B	A lot of thefts going around recently. You used to be able to leave your house unlocked, not any more.	
137	456C72N8TN	It's a lovely place.	
138	RAYC44BCYK	Because I have grown up here, I feel safe. The West Coast is home with the most beautiful scenery and a great community.	
139	2EH4T6A26C	I think we have got good lighting and good streets and are a friendly town.	
140	WV2J8J2HSV	It's a safe place, I think we don't flood badly here and I think our climate is milder in winter. We have lots of water.	
141	57HB4847V2	Increased violence and drug use. There is a problem for youth with little to do.	
142	GV456A27S2	Nothing is 100% safe.	
143	6C4857423N	Because of what you read in the court news.	
144	8W7D635E82	I feel perfectly secure and feel like I can wander around in the dark.	
145	X62662QKQK	We can go out at night and not worry about our safety.	
146	662BB7TCJ3	An element of people coming in and slightly cheaper housing.	
147	T84558QRTP	The people are nice and usually everyone knows everyone.	
148	6R6KE5AGH7	I'm always out on my own and I feel safe.	
149	BJ4326F584	I think different areas have different problems.	
150	UGL6JFM7Y7	We live at the end of a no exit road and have no problems. Never any thefts, I've never felt unsafe.	
151	W2UKV68JRB	It's a good community.	
152	Y6C8838W77	I don't feel safe to leave my vehicle running outside the shops anymore. I would have done this a 10 years ago but not now. Lots of new people in town.	
153	5EH446CCX7	There are so many new people coming into town. You don't know a lot of people now.	
154	5J7V6568U3	I think we have Police in the right places. I would be happy to walk through Hokitika at anytime of day or night. It's well lit.	
155	FVC3Y4G33S	I think the Coast has that "gold NZ" about it. People still care about each other. We don't have gangs here which is another good thing.	
156	B2H2YR82YW	You can walk around the streets at night and feel safe.	

157	U6G75T53UA	We are friendly and a cool little town.	
158	DE6N88483X	Everyone one knows everyone. I feel safe.	
159	Y4T6SXN55X	Nowhere is perfect. I don't have contract with people who would make me feel unsafe. I know there are drug problems and violence and drunk driving.	
160	E82R52F8L7	Never had any problems here.	
161	P8H6A5Q4LM	There are not too many mongrels here yet.	
162	X2ERX738UV	Still a bit of community spirit, looking after the neighbours.	
163	2Q52T82HDR	We don't seem to have any issues I am aware of.	
164	8X3E5NT22Y	There is hardly any of us, generally we are tolerant of others. The criminal element is usually from out of town.	
165	4XH8LS6SPB	Everyone is laid back. We still leave our house unlocked.	
166	3347N64L6D	Everyone is so nice and friendly.	
167	6SX7EY86P7	There is still crime here and a lower police presence with no tourists. There is a certain group or groups that are criminal and that puts you a bit on edge.	
168	Y866Q3LE68	It's fresh air and sunshine, pretty safe here.	
169	2V6XP654K7	I don't know where the keys are to the house, we have no problems.	
170	426C258U5E	Never seen any problems.	
171	J4KY6P3YKD	I think it's generally safe, I'm comfortable walking around the streets. There is still crime, but not too much. I think it's a safe place to bring up kids.	
172	CDJA4B5583	A good community neighbourhood, people always watch out for each other. Problems are usually sorted quickly. Our community in Ross is getting divided at the moment and it's all over a Chinese garden.	
173	YH7YFVDJR5	We have our own policeman. I feel safe. I now lock my doors when I am inside. I feel safe, but not the same as it used to be.	
174	AWW62AQ34M	They need to do more to make the district safer but that would be to improve the roads.	
175	K534CT2H2B	We have a very good environment and we are happy with what goes on in our community.	
176	P286JRDW4W	I think it's a safe place because it's a small town. We know each other.	
177	4SQBVG847R	We never seem to have any trouble.	

178	8B2HAF777F	We have shifted house and it feels so much safer than where we were before. The crime level is pretty good at the moment.	
179	WKM64FDYKK	We don't have crime here like other areas. There is a certain bad group, but kept under control.	
180	HLQ3E5E83V	You just have to look at the rest of the country it is a pretty safe place, we don't make the news very often, do we.	
181	WH84K66K5T	Probably because most of the population here have been here a long time. It's always been a safe place. We have a wee drug problem but I steer clear of that.	
182	53FS6EY87H	There are so many gangs moving in at the moment, it's not as safe as it was.	
183	2QQ6HFW3FB	The community is great. We are minutes away from everything we need.	
184	NS33G7VHR6	We never had any issues.	
185	K483R3C875	It is basically rural and everyone keeps an eye out for everyone else.	
186	2P54MQGM4U	I have had no trouble since I have been here and I have moved from up North and had no issues here at all.	
187	CJ35UW35XL	I came here because of the safety. With Covid the environment is changing for worse.	
188	L2D2PH22VE	Not very much crime where I live.	
189	73EM4RJVB3	I think there is next to no crime here and everybody is friendly and there doesn't seem to be any trouble.	
190	S8JCE8N2L4	We haven't got too many scumbags living here.	
191	27N784YF72	Crime is low in the district. The drug scene and gangs only seems to be emerging now.	
192	UJAREF753S	We are a supportive community down here.	
193	67R33EN3J2	Isolation and the weather make it a bit unsafe. Things take a lot longer to get here.	
194	M2W4876DV2	Safest place in NZ. I've seen what goes on in other communities.	
195	DT28MAD2M8	You can walk down the street and feel safe.	
196	46C754P4NL	Here again it can all boil down to where you live, the neighbourhood and the environment. Some place wouldn't be as good as other places it just depends where you are.	

197	PAU87M336U	There is a high earthquake risk and very damaging rainfall levels. With climate change these dangers are increasing.	
198	5N242MY7M3	I have lived here all my life and I feel very safe. There is very little crime and people tend to know where people are from and what they are about.	
199	858455DF8Q	No gangs here, everyone looks after each other.	
200	PKL6V82LAQ	Due to P usage on the Coast. I am really aware of the use, due to my job. Saw a man getting his P fix in the public toilets on the main street. It is a transient community, especially with Covid. It's hard to get a community feeling. Police resources are stretched and emergency services are sometimes not available. If we lose power, people can't contact 111.	
201	8Q78GWK2J7	It's a small town and everyone helps each other.	
202	TU68W437D4	It's a good place to be with Covid. Very laid back. I'm very biased.	
203	43GWDN347K	We don't seem to have the gangs that the cities have that I am aware of.	
204	L2N2APH5X4	We appear to have a very low crime rate.	
205	E25NH74J35	Because of the population basis. The services aren't overrun. I think the councillors provide a good variety of knowledge we have good range of people. There is a good range representation on the council. We have a good variety of volunteer services and a stable population.	
206	YB27FDA73N	It's a lovely place and feels safe.	
207	3HJCND837D	That is just how I feel.	
208	R26622CD56	There doesn't seem to be any hazards, we don't have any flooding problems.	
209	G784D2BM76	I feel the safest I have been in my life here. It's a warm welcoming town. It has a positive vibe to it. They all stick together and look after each other. It's a tight knit community.	
210	UJGEY57452	Maybe better street lighting in the town and surveillance cameras. Some of the footpaths are unsafe.	

211	2635ES2B37	I think it's wrong community leaders would like to isolate and belittle people. For me that makes it feel a bit unsafe. If the Mayor has it in for someone, he doesn't stop. You can't act like that. When you are run by people who take personal grievance when in a leadership role, they are mentally dangerous to those he is trying to isolate. If the Mayor does not like you, he will make life difficult.	
212	BNSVGVR5H2	I have been here all my life and have no reason to leave.	
213	4UG22H6577	I don't know of any gangs or anything around here, we have never had any dealings with that and the police are always out and about.	
214	5JT884783L	I have had no troubles.	
215	6Q6KD7CS2Y	I feel really safe here.	
216	7EPNE68RL3	I feel safe and my family is here.	
217	SF7VK83VLX	I feel very safe.	
218	XTE4DV4N67	I have had no problems with anything affecting me.	
219	PX4U2527J7	I think out of all the towns on the Coast it is a positive place to be.	
220	JWG88HH5R6	I've feel totally safe here. I go out at night no problems. The police are there.	
221	P22B484432	Where I live I can leave my keys in the car and leave the door to my house open and nothing happens.	
222	J3J5245PKG	I feel blessed to live here.	
223	44C4274N37	The police service is very good.	
224	B2VV7VAC66	I've never had any trouble, not a lot of crime.	
225	R4866LMG46	This is a nice small community and I feel safe. I have lived in bigger places.	
226	2448LYU6C4	It is safe. I'm 4th generation, I consider it safer than Greymouth and Westport. In both towns they made Mongrel Mob, we don't have all that stuff.	
227	VLK4277643	We haven't had any problems.	
228	Y8VS5DP4QX	There are a lot of rotten buggers around and you have to lock everything up and be aware of what is happening around you.	
229	B66QWYY5A3	I haven't had any bad things happen but I am careful where I go. I have had a couple of incidents of unfavourable touching (when I was over 80). I haven't told the police yet, this was a trades person in my house. It's really bad here I think.	

230	8T73352N2S	Because we have gangs down here now which we are a bit wary about.	
231	MA3MNV5G6K	We still have a feeling of a small community with people looking out for each other.	
232	W2846MBGT6	I think it's great here, wouldn't want to live anywhere else.	
233	6N823PSCYD	It's as good as any and it is the only place I have ever lived.	
234	2K5UUH3A38	I have no real concerns about people being opportunistic. Ross is quite a safe little township.	
235	K3E36JQ554	I can walk outside and feel safe. The crime here is only petty theft.	
236	FLQ7SE3Q7W	We live out of town a bit, I have never experienced any form of aggression. It's a lovely area to live in and people are friendly.	
237	34R44PR7BC	We still have far too much crime. The police don't work often after 10 pm. They should be lined up with Greymouth and work 24 hours.	
238	535236444W	Everyone is aware of what is going on. Everything is under control. Problems get sorted quickly if there are any.	
239	C6XTP2S2VT	We don't lock our house and there has never been a burglary.	
240	H45DR6Q7CL	I know there is a few mongrels around but still a safe place to live.	
241	6JTWG57DQ7	I have lived overseas and travelled quite a bit and find it very safe here.	
242	N86ER5Q8N6	Most people look out for each other. It is a good community. I have health issues and people will always offer to help me out. Very friendly. Great St John's Ambulance but poor medical service.	
243	Y7E4F7GX3V	I feel safe here.	
244	F43TESSLWC	We have had lots of new people come into the district and some are used to living differently from West Coast people.	
245	B7MCC3GU75	I was born and bred here, it's my home and I love it.	
246	FXJWRQGK66	There is always the odd incident. 20 years ago I would have walked the streets at night, but not now.	
247	V22F86J7W7	Low crime rate.	
248	8D6PWJ342N	We haven't had any trouble.	
249	35APA22B6C	There is crime even in our little town.	
250	36D8F2U42H	It's small and community orientated. People seem to look out for each other.	
251	32J3D3NDE7	There is not much that goes on here.	

252	X8KEV73H64	It's gone down from when I was young. There are a lot of nasty people out there. I wouldn't let my kids roam like I did when I was young.	
253	K3VH48J5G5	There is a high drug and alcohol problem.	
254	5H7T368E7Q	I live down the road from the Police station. The town is quiet and well managed.	
255	533KA6HWM7	It's a good place. I feel safe.	
256	3678C7S5DJ	I have lived here all my life. I live alone and I hardly know anyone now, all the people in my area are gone.	
257	F5TAMAFTFM	Apart from expensive rates everything else is pretty cool. Excellent fire brigade.	
258	57BVPQ3LG5	Because it simply is. Compared to the rest of the country it is a pretty safe place to live.	
259	CT6N53CTB5	I have lived in Auckland and there is a very big difference, you feel far more secure here. Everyone is open and honest and I haven't heard of any crime since I have been here.	
260	8W243TKGVU	It is still a community and is relatively isolated and you know most of the people in the area.	
261	PU7K2T856P	One of the safest places in New Zealand at the moment.	
262	87M8D3Y3XA	There has been recent crime, my neighbour 4 doors down was burgled.	
263	4L27755LQV	One is isolation but two is the type of people that live here.	
264	6825K3434Q	Locals look out for locals.	
265	4JKD4LBAG5	I have lived in the city and I have lived back here for 40 years and I have never had any problems with security and the police respond to any incidents.	
266	B8PAL2GC2E	Nowhere is a 100% safe ever but it does feel safer than the larger cities.	
267	4AAETXCE52	I haven't heard anything.	
268	K3753624GS	We have a friendly community and easy to live in, that makes me feel safe.	
269	4W2J56W854	No reason to feel unsafe.	
270	7SBT545PMM	I was born and raised here. Everybody knows most people in the district.	
271	J42P5854WQ	We don't have much crime in town and its safe to walk around.	
272	78AE8KNQH2	We have a policeman based in Ross and it makes me feel safe as I can call him.	

273	4M38RHG62Q	We have had no problems but we still lock up because we just don't know what is round the corner.	
274	UG7P765663	I have lived here all my life and I have never had any problem with gangs or violence and I feel safe in the community and around the town.	
275	88U48N2668	Crime is low. Partly helped by population density.	
276	W8AQ5R67Y2	We have small towns and try and look after each other. We do have people in the township that don't obey the law.	
277	Y73Q3CU7W6	I leave both my front and back door open everyday. I think people look out for everyone.	
278	V56F7D2Q3D	You haven't go too many people, everyone knows each other.	
279	BRT5377RB2	It has a community spirit. People look out for each other.	
280	2437XK4KYJ	I think we have a caring community.	
281	PENY3T2G66	I feel safe in my own home and safe in the district.	
282	YC2R644387	My neighbours look out for me and there is a good sense of community.	
283	FSK7TSGQT5	We have a low rate of crime. We are isolated, so because of that we are last to feel the pinches that others feel. We are not over populated.	
284	P47N5FJRVX	Have no trouble where I live here. Whataroa is a very safe place to live.	
285	7Q7LA43835	I think because of the isolation, there is not much riff raff.	
286	387TWJ2M8U	There hasn't been violence in my area.	
287	K5JSH84Y3N	It's good for the kids. Everyone looks out for everyone.	
288	X8TPY5L4Q4	I can leave my house unlocked and I can wander round the streets and feel safe.	
289	CQB8C3BW84	Because of low crime and when there is flooding or any disasters, they are pretty quick onto the job for example the flooding at Mt Hercules about two years ago. I was very impressed with how quickly they got the road open.	
290	8UXTAV88UK	We live out of town.	
291	5MK7TD7M47	It's the best place on earth.	
292	7S55GJ58HV	Because it is!	
293	L5NNC43B46	I have never had any issues to my safety or that of my children.	
294	JWBMH76AQ8	I never had any problems.	
295	3VV67QH5QG	There is still the odd drug addict around and theft.	

296	L28C2QV6P4	Increasingly there is petty theft happening more often. Drug use also seems to be increasing with new people coming in.	
297	KCU5S46U5E	It's nice and calm and people are friendly. No hassles, no gangs at the moment.	
298	QB5E7J77DV	It's okay, it's not a bad place to live. I'm sure there are some things that go on.	
299	22538TJ3D8	I have never been attacked or abused. I think the community is in touch with each other and belongs to certain groups, I think that helps.	
300	4L5S6G66FV	We've always felt secure here but now we need to lock things up. It's a bit of a dog-eat-dog mentality at the moment in the community. There are huge communication problems by leaders. It makes it uncomfortable.	
301	688P4R4224	I think mostly it is a safe area but there are a few undesirables that have been brought in because of housing issues in Christchurch. i.e. the gangs that were brought over to the West Coast.	
302	763D7YL82Y	I don't have any issues with safety even though you hear the odd thing I still think it is a good place to live.	
303	3NQ5V6US48	There are gangs moving in. Years ago there weren't patched members around. Like the rest of New Zealand, we are evolving.	
304	4E8KDC67TQ	I don't have a river and risk of flooding. I feel safe.	
305	TK5V44Q57X	There are drugs and a lot of police around. It is getting worse. I stay away from bad people and the pub is not a good place to go.	
306	DDV2HT7C22	I don't lock anything and have no problems.	
307	B5CULLP7AY	We have crime like any other place but pretty safe all around.	
308	QD3TK637P7	I've never had anything to worry about here.	
309	QLS573GN28	I've been here all my life and I have no complaints.	
310	6BQ3VTVMNU	You need to lock everything up now. Years ago definitely.	
311	37F8SHB673	I have a neighbour that is always getting in trouble with the police. He is in prison, but he will be getting out soon. I'm not happy when he is there.	
312	G55LA65TF3	I think it's a great place to live.	
313	FT6N23445V	We are out a bit in the country and we don't have any problems out here.	
314	343E225W2S	You think this place isn't too bad, when you have visited other places.	
315	7D3VG8X728	You can still walk home at night.	
316	6323R7V86N	I've had no problems personally.	

317	6E2588HW8X	I've grown up here and I find it safe. I let my kids out to do their own thing but not after dark.	
318	H6NLEH4DGV	Everyone knows one another. We have Police here.	
319	47H7M86N3Y	I feel very safe here.	
320	BC26P2B2Y2	Nothing really happens here.	
321	T3Y8W7A4B7	I have never experienced any threats around town or anywhere in the district.	
322	R5PYBLW726	Everything can be good where you live and you only need a gang member to shift in next door and your whole situation changes. At the moment I feel safe but that could change at the drop of a hat depending on who your neighbours are.	
323	7L8Q227KQN	I have been here for 20+ years and had not have problems.	
324	332RC574B4	It's still a small town where people know you. We don't have a massive problem with other influences.	
325	W8AGL24Q65	I've had no problems with theft or any aggression in town. I've never felt unsafe. I'm happy to let my kids go to the park during the day.	
326	7WN6EF6QR6	We don't seem to have many ratbags around.	
327	55V334QH5E	Crime rates are pretty low. I know there are concerns about drugs on the coast but we don't see it here. Where we live is a small community where people know each other and we are pretty safe here. Word soon gets around if something happens in a small community.	
328	BEE36R68LK	Safer than anywhere else.	
329	22XLP75L26	There doesn't seem to be very much crime and you can walk around the streets without fear that someone is going to grab you. There doesn't seem to much gang presence in Hokitika whereas there is in some areas of the Coast like Greymouth and Cobden.	
330	RXGE7NGN6F	I can't see why it is not. It is safe everything is here.	
331	RR6V368W5C	Where we are, we don't have a lot of issues. If there is any issues it's usually from outsiders. We now lock our doors.	
332	EKXH8Q48D3	We still go away from here overnight and leave the door unlocked.	
333	8Q2HQW3NU7	The crime levels are not that high but there is an undercurrent drug scene.	

334	EFH878538N	We haven't got the traffic they have in the cities and we haven't got the crime they have over there. You can walk safely at night and I wouldn't do that in Christchurch.	
335	546WDMFKVS	I look at places I have lived when I was younger, what is happening in our country and the rest of the world and we are living in an incredibly safe place.	
336	282L73HFGF	There have been a few incidents that have been happening in the district in relation to theft. This is new for the area.	
337	V658BR7F23	I don't think we have criminals down here.	
338	M53YV7APJK	There is no trouble here. You would have to go out of your way to find trouble.	
339	HG7T57JP7N	I've never had any problems and I've lived here all my life.	
340	6R84Y8YQH7	I feel safe, it's pretty good.	
341	76YESW52T7	I feel safe living here from everything, crime and pandemics.	
342	6W7D633T4E	Apart from our difficult neighbours it is good.	
343	H6568442JC	It's a happy environment and safe for little kids.	
344	264YR7VM6W	At the moment there is not a lot of crime going on. Not that I have noticed but you don't know what is reported. If it's not in the newspapers you don't know about it.	
345	7EV5S734X5	I haven't been affected by crime or anything that I feel threatened by.	
346	A62R6KJA5T	Put it this way. I came here for a weekend in 1983 and I'm still here.	
347	36XK3J4467	There are issues with crime, alcohol and drug addictions. I'm glad my kids are older. It's not as safe as it used to be.	
348	WQ5ENR277V	I have never seen any instances of crime.	
349	77YE28M733	There are rural area that can be a bit sketchy.	
350	2RB5EH467J	No place is completely safe at all times, we don't know what sort of people are coming in and out.	
351	P338684522	I have a few friends that have been complaining about Gangs in Greymouth and increased crime so I think they are in the area.	
352	4X36NBL46B	I guess me and my family have had no concerns for our district. I think the police resourcing in the district is adequate and they have a good presence in the community.	
353	WPBTLAH42C	The population is small so it's not too bad.	

354	L2J538668W	Having children of my own and it is a small community. The community works together to help each other in a small place like this.	
355	GN3AG8WR23	I love the place and think it's a great place to be but it's getting ruined by this carry on from the Council.	
356	J2WDW8LUR2	I come from Christchurch and we feel quite safe here and I have never had any issues.	
357	6KG4BGW5B8	Because I live alone and I go walking, not so much at night anymore, but I don't feel threatened by anyone.	
358	32SVGKB8P7	More people are coming from outside and it's not the community it used to be. I've tried to get hold of the Police, so on occasion I have felt on my own.	
359	4HE3TK7VYL	It is a small community and we don't seem to have too many problems.	
360	TS8NPE3462	I just like the town and I think it's a lovely little safe place.	
361	5MK2M5TDNU	Certainly in Hokitika, we have very little crime that impinges on me.	
362	325NDUN472	I haven't had any issues.	
363	82CWA4CV25	I just think with Covid everyone has been fairly supportive of everyone else.	
364	256AG8Y5H6	I feel the town is safe from a crime perspective.	
365	7CAPDJ8M83	We don't seem to have a whole lot of problems compared to other areas. We doesn't seem to have the same sort of issues.	
109	KA82BEBU26	People care about their neighbourhood.	
110	3757SPASR8	Small positive town.	
111	MJG8F4JV43	Police issue - not Council.	
112	55SPBL7SP5	Crime is low.	
113	3GTK5ESA84	No gang activity. Little to no major crime. People look out for each other.	
114	NQKM2PKP8M	Don't have any problems.	
115	ACPMLUKMGU	Easy shopping good size to go around.	
116	JXBBW63T4W	No rough sleepers. Very little vandalism. No \$2 shops. Local police stations. Community spirit.	
117	35A5E3548G	The community come together to make this so, along with staff in authority to police the area as required.	
118	7V8E3W6MS4	Never feel threatened in any way. Crime rate is low. Have no hesitation leaving property for short periods of time. No need to lock 'cause in town.	

120	UP62Y7LN68	Small communities and towns. People look out for each other.	
121	778WAA26CB	Very little crime.	

ID	RC	Q52. Are there any other comments you would like to make about Westland District?	 Index
1	2XRMG654MU	No -said all I want.	
2	X25A3345RD	Don't know.	
3	3H82BQQKQ4	The Hokitika area is looking very unkept. Entrance to town is disgusting.	
4	U2224FFPK8	More control of Westroads contracts and work standards needs to be undertaken. Mowing of all Council owned parks/reserves/riverside/roadsides land needs to be improved. Clean out of all roadside drains in the town should be improved to prevent "heavy rainfall" flooding.	
5	LW76DQBE76	This survey - I hope you haven't chucked any silly money away on it yet. Money that could be spent on footpaths or water supply or something else useful.	
6	8RPPR24Y7T	No.	
7	P666QY85R2	I am not a rate payer but I see huge waste of rate payers money happening.	
8	GVX74254L7	The council controlled companies have people on them that need moving on, fresh start and back to basics. An emphasis on reducing spending and going back to core business needed. People need to be appointed on merit not on who they know etc. No confidence in the council.	
9	7LR78WY7B5	No.	
10	FDB8882NT5	Nil.	
11	MTCU476NKE	They need to be upfront and honest on what they do and look at the overall picture of the whole district not isolated areas including the companies under their umbrella.	
12	K6P56EEH6H	No comment.	
13	H4RR2WK3J4	I don't know.	
14	54GBDSTCK2	Stop mucking about with too many consents and get on with it.	
15	NQJ27533B4	Too much wasted money on poor stuff and not enough on core services, for example, WDC has blown who knows how much on Revell Street one way yet my footpath outside my house has a giant crater in it. I've reported it to council but you're all too busy worrying about Revell Street to see that the rest of the town is falling into ruin.	

16	FS75M2K5T5	We have to pay \$24 for rubbish collection, while paying rates. There is no recycling options here. The expensive rubbish collection is making people burn rubbish. Which happens next door, smelly smoke blows to our house and its bad for the environment. Hari Hari has Christmas decorations in tatters. The Christmas before last (which we had no decorations for) I had to ring the council to take down the Christmas flags down just before Easter. They were ruined.	
17	55S8283EP8	As I stated in a past question. Hari Hari, and probably the other small towns don't get what rates should pay for. Like rubbish, recycling, and for us, Christmas decorations.	
18	HF23E8B8GJ	I feel that for what we pay in rates and the fees to build our house the services we get from the council are well out of proportion. I appreciate it's not an easy task but don't just money grab from those who use the least services to help the ones who burden the most.	
19	57Q7744356	Each councillor has been elected, elected to make decisions in the best interest of the entirety of Westland residents - not to a small group who won't be quiet.	
20	P73DLWYA36	Hokitika has spots in the township for three GPs services yet the current GP has control over these three doctors, it would appear that no one else can come in to the community to practice medicine unless they work for her. {that is not right}. The residents of our community want more independent doctors and choice.	
21	VNUSJ4AV65	Rates have risen quite a lot due to poor investments, the council should never have been involved in or used the ratepayers money for. They should stick to what we pay rates for maintenance of our infrastructure etc.	
22	6W5B6W3TVB	We should only have elected people on the council not based on race, if they were any good then would be elected by the people.	
23	6PW48NAX62	Expenditure on facilities such as the greenstone building, library and museum is concerning, decisions regarding these are headscratchers more explanation would be helpful.	

24	QRHC76CTH3	Reiterating, a children's upgraded playground would be beneficial to the district, not only for the local families but also for visiting families. The current one is very unattractive and uninspiring. A few years ago[3-4?] a survey was sent out pertaining to the local footpaths and roads. There hasn't been any upgrade of footpaths to my knowledge, some of which are in need of attention, particularly as there is a significant elderly population residing here using mobility scooters, wheelchairs, and also with young children riding bikes and scooters. Considering we had a substantial rate increase this past year, more so than in previous years there is some areas of improvements that need to be made.	
25	834ELHK644	No.	
26	6YAR5TG72H	As a commercial ratepayer I'm really annoyed that we pay a compulsory tourism promotion rate. In the commercial zoned areas property owners should pay commercial rates whether they have a business or not. Some accommodation business owners are only paying a residential rate.	
27	PTBF52JTX5	No.	
28	825AVGB5PR	We need democracy and transparency. Not a fiefdom run but a egocentric personalities with personal agendas. Fully support LG review from Nanaia Mahuta and hope to see big improvements at Westland. In reality, we do not justify and separate council entity for the size of the rating base. We should have only one whole of Westcoast council.	
30	3KE5FH3P76	More care could be taken with grasses and walkways to keep overgrowth at bay.	
31	37GJ3775R2	N/a.	
32	6D48LD2S7S	The footpaths need attending to, they gave up mowing verges, its a bit of a backward step, but the bees and insects probably enjoy the foraging.	
33	TH2WQ55K88	No.	
34	2383T8RB3Q	Again, acknowledge there are other towns in Westland District outside Hokitika that need more help financially and physically with their recreation grounds, their roads and footpaths and their community halls.	
35	LBBVEH73DC	No.	

36	65C628644P	As in previous answers. I think there needs to be a professional plan done for any development in the CBD. It needs to be in line with what we have the ability to maintain. Our entrances to town and the airport areas should be immaculate. It is people's 1st impression that is lasting. In general do less and do it well.	
37	X6332J56L5	Footpaths needed to be looked at in Ross. People with disabilities are becoming housebound as they are fearful of tripping if they go for a walk.	
38	64VAT555WP	Coming from living and being a ratepayer in other districts around the South Island. Westland is the worst unfortunately. Park/playground facilities are huge for me with two young kids and they are non existent here. Our rates are the highest I've ever paid, and my house is the smallest compared to other homes I've lived in elsewhere. I don't feel I get good value for money with my rates. Especially now I'm unable to use key facilities due to the councils decision to use the vaccine passports. There seems to be mismanagement of funds at times, money not being spent efficiently, priorities are elsewhere and the rates hikes recently (and continuing!) are extreme!	
39	35C2553333	They are great.	
40	54M86G63X3	The council has too many staff who are inadequately skilled and lack competence for their roles. The salaries in the top 50 percentile are commensurate for the roles - but the majority of the people are not. The council performs badly because of inadequate governance and leadership - the two generally go hand in hand. Many of the 'skilled and well paid employees' I have spoken with can't possibly fulfil the basic functions of their roles - hence the phenomenal use of consultant resources. If this were a business, it would no longer exist. I am not seeing any of the great achievements of other district councils being used to guide this council. By and large there is too much inadequacy and arrogance to learn, change and develop emanating from the elected officials and council leadership. The water and sewerage systems (for the last 30 years) are an excellent example of what NEVER to do - and why the Westland District Council will continue to fail their people.	

41	5384P8T83W	More and more families are moving to Hokitika, however there don't seem to be access to family services to keep up with demand. The Cass Square playground is a perfect example. This playground had both slides removed around 2 years ago, various apparatus has been removed and the gate latches don't work. This is not an inviting space for families to take their small children to play, no money has been put into playgrounds for quite some time (with the exception of the beautiful new picnic tables recently installed) for children and yet council spend a ridiculous amount of money on a "trial" one way street which was not needed. Children are our future, there are other reserves around town that could be redeveloped alongside Lions Club into play grounds or Nature Areas.	
42	5DUN8473FX	My scores would probably rise if potholes on sealed roads were dealt with faster and a rubbish/recycling service was provided in my area.	
43	BW23G6Y52S	I don't seem to get anything from council - I pay rates.I get no waste or recycling services, my road is gravel and unrepaired for months on end. As an unvaccinated family we have been unable to use facilities that we pay for in our rates like the pool and library for many months. There is no value for money.	
44	VH5435CYW4	No.	
45	R7658647RH	:)	
46	36P84B53VW	I think there needs to be more information about council and how they are more cost effective than their operations being in house considering all the directors fees that ratepayers are paying for. Basically I don't understand how they work.	

48	8VN8L8D53M	We a pay high rates for the services we get. It wouldn't bother me if we had the basics under control such as glass recycling, water (the pipes keep bursting on our street), flooding (the roads and houses still often flood after heavy rain), communication networks (fibre cut) and cellphone coverage (patchy at best out of town). But we do have these issues, and often. I don't care if you are responsible for one or all of these issues, and I don't want to hear excuses about how its someone else's fault. You, the council, are responsible for taking our rates and making every penny count to make our district a great place to live. And in that regard you are failing.	
49	3666654NN5	No.	
50	75UK66R6MG	No.	
51	64W5L87428	Need a new leader who is honest and open about matters.	
52	YU2F24Q23F	It is unclear why the CEO needs 3 office support staff as well as and HR and Business Officer, not a big enough organisation to merit this number of admin staff.	
53	P3SWVQTWUU	No further comments.	
54	CTCL5YBCBT	They appear to be promoting "Our cool little Town" very well.	
55	USRMSM38VW	No.	
56	36G43R3455	Get a Mayor that will listen to the rate payers and just don't go and waste money on things like buildings that they don't need.	
57	VB8445N866	Dealing with the media training get some. Get the good stuff in the media. Sell us more pound progressive. Cycleway, address the person issue. Great cycle way. Great visitor love it. Sell the rain even, this where we keep the country's rain forests.	
58	6FDJXE4GDP	No.	
59	E87LH5NUE2	Nothing to add.	
60	QTY2JPPT76	There is NO government entity that is productive enough for the money they spend. There simply is NO efficiency in Government systems. Having said that --- I think Westland is better than most regarding services and facilities.	

61	Q336266YNQ	This council does not care about normal people. Families are struggling and spending on silly projects to boost their egos is pathetic and uncalled for. We can't even get our water pipes fixed properly, but this council has heaps of money to spend on projects most people don't want. These people don't care about the people that pay their wages they will just spend all money on stuff we don't want or need.	
62	A666XC43DA	They need to make more outdoor spaces. Dog parks. Better playgrounds. Outdoor gyms.	
63	23A22P6JC4	Rates increases getting too high, too much excessive spending on needless projects.	
64	S2Y7GY6GC2	The Council need to listen to the rate payers we are the people that pay for everything that is done within Council we live here and suffer the mistakes Council makes where as those in office can ruin this beautiful community and then apply for job in another town or City and we are left with there mess. Queenstown suffered this problem many years ago where the locals could no longer live in their homes due to the price of rate rises forcing them out. Also when trying to save money, you don't lay temporary concrete, hence the one way street that no one wants and all the wasted expenditure that has gone with it.	
65	7AECJ6CLPB	It does its best for a smaller and older community.	
66	PMA6Q5Q7XW	Nope.	
67	WS6CSX32Q4	No.	
68	R3X24YR7Q2	Keep up the good work in these challenging times.	
71	UFK8ACBNBG	The Jade building?? What a rip off. Also, too many highly paid staff and services not required.	
74	B5JNC2UM87	If there is a public consultation, don't ignore it as has been happening.	
77	VL6D76V6X3	Why in past years, has so much money disappeared and no-one is held accountable?	
78	3L37MQ3J26	I think Westland is too sparsely populated to support living here. Things like Three Waters are essential to provide those things to this Council. Repairs and maintenance of systems are poor, refreshment is required and the residents here cannot afford to update them.	

84	QV2YS76L5H	They're doing a good job, progressing forward with new ideas but need to keep maintenance of extending assets, e.g. footpaths, etc.	
86	4275JK5777	There is not enough money to do all the maintenance, for instance, roading and footpath repairs and keep rates reasonable.	
90	AHL3R2QFJ6	I feel a monthly progress article in the newspaper and via email would keep the people more connected with Council.	
91	F58EP6T55W	Council needs to listen to ratepayers.	
96	435XJ8MA3Q	Have leaking water main for five years. Bring on three waters.	
98	US7V7A5822	This coming election should be better. Not sure about the current mayor.	
101	B77M46MPX2	I rent and have zero contact with council.	
102	6T5FUTUW6A	Spend more time on local problems, less time on promoting tourism.	
103	JH3MK5S3P2	These people are elected to serve the people who elected them. Listen to what they want.	
104	66867BWNWM	Kamara roads, stormwater, footpaths and roadsides all left to tatters. We now pay same yet do not even have storm water and property floods when it rains.	
124	LQ7G3766CV	I had an instance where I had a blocked drain. I contact council for them to look at it, one lot told us it's not council and told us who to ring, they told us it's council. We rang council they said they would come, they never came, I rang, nothing happened. Then I looked line and saw the pipe online on the asset plan as being theirs (council) and then I looked again (next day) and it was gone as showing to be not owned by council. Now it said owned by the property owner. It is strange how the ownership of the pipe changed over night and nothing was ever said about it. How much trust can one have in council when they do this?.	
125	U7BU3K4CB5	No comment.	
126	6274MWB7N2	No.	
127	7RLRWB7TC4	No.	

128	7BTPY766AV	Rates - out rates are very high. They decided that in the last 12 months to charge me commercial rates as I have another property on my land. I had to battle them for this. They were doing it for Air BnB and this was not one. They took extra money out of my account without discussion. It was like being guilty and I had to prove my innocence. I live in a house with a stunning view of Mt Cook. They built a sports facility, the roof level got changed without consultation and we all lost our views of Mt Cook. They did this after the consultation period. This is another example of them doing stuff without consultation. There are a lot of people in the same boat who have lost their views and are not happy.	
129	5SG6RK6A7V	No.	
130	3QJ5765K85	We need this Council to change.	
131	VB7BP2867S	No.	
132	VPV6WSQJ2E	No.	
133	588EMC6GSB	Rates, we got behind and there was no consideration for trying to keep us in our home. We have struggled since before Covid with getting a bit behind in the rates. They just put us straight to the debt collectors without discussion.	
134	SK7L58GX5M	No.	
135	52A4K3X883	It would be awesome if they could do more for the kids.	
136	PM83823Q2B	Along Gibson Quay, they used to mow the stop bank, they have stopped doing this and it looks very untidy. Maybe fixing up some of the damaged gutters on Gibson Quay when they dug up the road. Some of them are quite broken. They should keep the Council land a bit tidier.	
137	456C72N8TN	Get your act together.	
138	RAYC44BCYK	I pay for my berms to be mowed and outside is a big lawn, up until 6 months ago the council used to mow it, then they stopped. They expect me to do it or pay for it to be mowed. Above me, people on scooters go across my lawn and down the side of my fence. At the moment the neighbour mows part of it and in the middle it's over a foot high. The Council said they will mow it sometime. It would cost me \$80 a month to mow this Council property.	
139	2EH4T6A26C	No.	

140	WV2J8J2HSV	Make sure they keep their costs down because people are struggling. The wages can't keep up. They need to tone down any inflation rates.	
141	57HB4847V2	I really disagree with this Council.	
142	GV456A27S2	No.	
143	6C4857423N	If they consult with the public the council should abide with what the majority of the public want.	
144	8W7D635E82	No.	
145	X62662QKQK	We are hoping that the current mayor resigns and we get a new mayor. The council sometimes does projects without enough consultation with the public and then goes into debt.	
146	662BB7TCJ3	No.	
147	T84558QRTP	I had a problem when paying my rates and the admin staff need to be pay more attention to detail and do a through job. Council should take into consideration that due to covid it has put a strain on a lot of families and not increase the rates too much. If its not broken do not fix it. The council should listen to what the rate payers want.	
148	6R6KE5AGH7	No.	
149	BJ4326F584	No.	
150	UGL6JFM7Y7	We have no serious problems with anything. There aren't enough rate payers to support what the Council needs to do.	
151	W2UKV68JRB	Probably need to have a more far sighted view in relation to climate change. When decisions are made on the stone wall (costly) and with rising sea levels if could be washed away and that money is gone. More emphasis could be put on moving the town centre. One of the big things is where the supermarket is in the most vulnerable spot. We have a round about at Kumara Junction and they don't look after it well.	
152	Y6C8838W77	No.	
153	5EH446CCX7	No.	
154	5J7V6568U3	Revell Street trial is a one way system. Totally abysmal, overspent, poorly executed. I think they have some trouble with their staff. There should be no reason for such a big budget blow out. There was a lack of overall financial management.	

155	FVC3Y4G33S	Since I have been here my rates have gone up 800% and I don't get any services except for rubbish. Since the new council has been in it has just gone up and up and up. I am on tank water and septic but I have to keep paying more. I am paying for peoples well being in town as for as I'm concerned. They Mayor is corrupt. Hopefully he will go to jail one day when they find out what he is up to.	
156	B2H2YR82YW	No.	
157	U6G75T53UA	We need new footpaths. They are a bit of a trip hazard and I have poor eyesight.	
158	DE6N88483X	They need new footpaths along the top end of Bealey Street.	
159	Y4T6SXN55X	I think they need to make more effort to let the public know what they are doing, not just put out a 10 year plan. A weekly forum would be good. They must do better with the unsealed roads.	
160	E82R52F8L7	No.	
161	P8H6A5Q4LM	No.	
162	X2ERX738UV	No.	
163	2Q52T82HDR	I think they do a pretty good job and it's a tough job.	
164	8X3E5NT22Y	They overspend on consultants. You need to be careful how much you pay people. My main complaint is weed spraying. They do kerbside spraying of weeds. They don't give us notice about when it is being done. They are not letting us know. I think they should stop using Glyphosate which is a known carcinogen.	
165	4XH8LS6SPB	A lot of the costs that are being handed to us are from Central government, you can't do much about it. These costs are a concern.	
166	3347N64L6D	No.	
167	6SX7EY86P7	God help us all!	
168	Y866Q3LE68	I wish they wouldn't spend so much money all the time. They have too many staff for the size of the town.	
169	2V6XP654K7	I'm happy living in the area.	
170	426C258U5E	No.	
171	J4KY6P3YKD	I think they spend too much on non-essentials. They need to do general maintenance such as footpaths. They need to be done now. Need to be more proactive with their maintenance.	

172	CDJA4B5583	I would like them (lot's of money has gone missing) to be accountable for their finances. We, the ratepayers are suffering for this. We are not being consulted about projects. The whole community must be consulted on big spends. That's why the Serious Fraud Office has been there. A lot of things has been swept under the rug. It seems to have all been written off.	
173	YH7YFVDJR5	They need to know that there are small towns as well as the bigger towns. They need to sort their stuff out.	
174	AWW62AQ34M	Get your act together!	
175	K534CT2H2B	No I am quite happy with the way they are doing things.	
176	P286JRDW4W	Customer Services people on the front desk should make an effort and smile. I think a lot more transparency is in order. The Revel Street budget should be shared.	
177	4SQBVG847R	I think they do a pretty good job.	
178	8B2HAF777F	I just don't really trust the Council and their spending.	
179	WKM64FDYKK	Thank God the elections are coming up in October.	
180	HLQ3E5E83V	No.	
182	53FS6EY87H	If there was not so much and there were decent roads our rates would be lower. Good luck to everyone.	
183	2QQ6HFW3FB	It's great to live here.	
184	NS33G7VHR6	No not really just I wish they would consult the people more and when they are consulting maybe the should listen.	
185	K483R3C875	No.	
186	2P54MQGM4U	No.	
187	CJ35UW35XL	I wouldn't want to live anywhere else in the world.	
188	L2D2PH22VE	I pay rates but I don't have the same as many others as I have no water supply and no sealed roads.	
189	73EM4RJVB3	Not really.	
190	S8JCE8N2L4	Not really.	

191	27N784YF72	I think the state of our footpaths is absolutely disgusting. There is no regular maintenance visible and they have fallen into such a state of disrepair that it will take millions to get them back to a satisfactory standard. They are not safe for our elderly and children. Everybody should be paying for the rock wall and its maintenance. Angle parking is better than parallel parking on Revell Street. The cycle train is really important and there should be more bike park racks.	
192	UJAREF753S	I am pretty happy.	
193	67R33EN3J2	No.	
194	M2W4876DV2	Can we please get our road sealed, and then we will give you at 10/10.	
195	DT28MAD2M8	The Revell Street trial. With the covid response they were quick to shut their doors and say they are working from home so that the staff can get paid a 100% when most of the community out there had reduced hours and reduced income.	
196	46C754P4NL	No.	
197	PAU87M336U	I would like them to look at working with communities not above communities. Our rates have gone up so much and there is very little to show for the rates increase. I think council should focus on core services and business before being distracted by entertainment events. They need to consult with the community about priorities.	
198	5N242MY7M3	I like Bruce Smith he is a good ambassador for the district.	
199	858455DF8Q	No.	
200	PKL6V82LAQ	I think the Council need to be looked at from the person who answers the phone. Such as not disconnecting the caller, not sighing and saying they can't be bothered. Replying to emails in a timely manner, not 3 months later. More transparency with upper management. Departments are silos and don't communicate with each other. If Bruce focused more on staying away from the camera and connecting with the locals but off camera that may build good will. They just cause so much frustration.	
201	8Q78GWK2J7	I don't follow much, I just go with the flow.	
202	TU68W437D4	No.	
203	43GWDN347K	Maybe they have too many staff and too much bureaucracy.	
204	L2N2APH5X4	No.	

205	E25NH74J35	They seem to forget that we are only a small population with a majority of low income earners.	
206	YB27FDA73N	I think they should be doing roads and footpaths instead of tourism which is not here at the moment. Spend money on the necessities.	
207	3HJCND837D	Not today.	
208	R26622CD56	No.	
209	G784D2BM76	It is a warm welcoming town and I am proud to live here. It's a lovely place to bring up children.	
210	UJGEY57452	Not really.	
211	2635ES2B37	As a community leader the Mayor should be more inclusive of everyone and not try to single people out. Listen to the people because you are spending the rate payers money. The community just doesn't see their vision according to the council. We don't have tourist \$\$ coming into town at the moment, surely they could have waited at least until times were better. For truck drivers, this one way road is a menace. The Mayor takes people to court who disagree with him.	
212	BNSVGVR5H2	The amount of rates that I pay for the services I don't get. I don't get rubbish and recycling pick up from my kerbside. I have to put it on the main road which is difficult for me to do. I use a private collection company.	
213	4UG22H6577	The rates are out of control everything is so expensive. Every year they increase their staffing and we have a mayor that has a website that he drives all over the coast and when I think about the expense of petrol, they need to get back to looking after the footpaths and council grass verges that they expect the residents to mow.	
214	5JT884783L	I don't like Revell Street being a one way street.	
215	6Q6KD7CS2Y	Improve community consultation and educate people more about recycling. Improve our basic infrastructure especially our footpaths and roads. The council said that making Revell Street a one way road was a six months trial only. It is starting to appear like a permanent decision to leave it a one way street. This is a classic case of them making a decision without consulting the public.	
216	7EPNE68RL3	No.	

217	SF7VK83VLX	I think the council does a good job locally and could expand its partnerships outside of Westland.	
218	XTE4DV4N67	I think they could improve the footpaths in places.	
219	PX4U2527J7	I think there has been some very unwise spending with buying the building across the road from the council - the mayor seems to think he can do anything off his own bat. It was an unsafe building to start with and then he expected people to come up with money to repair it because it was leaking and unsafe.	
220	JWG88HH5R6	I just think the Council need to start listening and stay within their means as it is becoming unaffordable to stay here. It is certainly unaffordable from a business perspective, especially is you are using part of your property for commercial activity.	
221	P22B484432	No.	
222	J3J5245PKG	No.	
223	44C4274N37	I am quite satisfied.	
224	B2VV7VAC66	No.	
225	R4866LMG46	I would like to see my rates not increase so steeply.	
226	2448LYU6C4	No.	
227	VLK4277643	We don't have any say in anything they do, we have to trust they do the best for us, sometimes it's good, sometimes it's not. We love being over here, it's marvellous.	
228	Y8VS5DP4QX	Keep the rates down especially for the pensioners.	
229	B66QWYY5A3	I am a quiet person and I have never been to a Council meeting. They have got to be honest with what they put in the paper as that all I see. I like living in this town.	
230	8T73352N2S	No.	
231	MA3MVV5G6K	The council seems to not focus on their main job like infrastructure. They seem to go off on tangents instead of fixing the basics first and then going ahead. I think the rates are way too high and increases should only match the cost of living.	
232	W2846MBGT6	No.	

233	6N823PSCYD	They leave the outside lawns for too long and don't mow them and I don't like that one way thing down in Rebel Street, everybody complains about that.	
234	2K5UUH3A38	No.	
235	K3E36JQ554	I tried ringing up to pay for my father's rates as he had just passed away and things were in probate. The run around I got was shameful. At times someone would pick up and at other times there is nobody. I live out in the country and I pay for rubbish collection which I don't get. I also pay for a tourist levy which is of no use to me whatsoever. I pay for two fire brigades etc. I need to pay for a separate company to come and pick up my rubbish.	
236	FLQ7SE3Q7W	█ at the Council who manages the customer services is very rude abrupt and uncaring. She is incompetent, ruthless and insensitive to peoples needs. The frontline staff, however are great. She seemed to take pleasure in how she treats people. She needs to go to a course for improvement on how to deal with the public.	
237	34R44PR7BC	Could be better. All they need to do is open those meetings up. Everyone knows they have to make hard decisions. Involve the public integrity and transparency.	
238	535236444W	Generally I think they are good.	
239	C6XTP2S2VT	The Councillors have a hidden agenda against the government especially with the three waters. They think they are bigger than what they are. They shouldn't be involved in national political arguments. I don't like being lied to about Revell Street, just be honest. The one way decision is a permanent decision. I am very annoyed about the council getting involved in national politics they should keep their noses out of national politics. They seem to have a hidden agenda. As soon as the labour government put a plan we know they are going to be against it.	
240	H45DR6Q7CL	No.	

241	6JTWG57DQ7	The council can put the rates up every year but it should be done gently as there are many poor pensioners and young families that are struggling especially in these unpredictable times. Someone with the mayors salary wouldn't have a clue as to how hard it can be. In these difficult times the mayor and Councillors should take a cut in pay. They tend to put money towards projects that turn out to be white elephants. A lot of things aren't really needed. The mayor and Councillors need to focus on their main job. If you have a complaint the council doesn't seem to take it seriously.	
242	N86ER5Q8N6	I would think one council for the whole West Coast would be good as it would be more cost effective but run by a Chief Executive not a Mayor. The structure would need to be good but I think I could work well.	
243	Y7E4F7GX3V	The Mayors mates all get resource consents.	
244	F43TESSLWC	They are bad in some areas and charming in other areas. The agreements that communities make with the Council, in good faith, it would be nice for the Council to stick with their side of the agreement. As far as the community, getting back to us can take months which is very frustrating. We have been trying to get speed signs for 15 years. We still don't have them.	
245	B7MCC3GU75	I think little jobs on the main road that the Council should do but they don't.	
246	FXJWRQGK66	No.	
247	V22F86J7W7	We pay over \$2000 and don't get any services locally in our community at all. Our closest rubbish and recycling is an hour North or South. How can the rates be this high? We as the community even fund the local school bus.	
248	8D6PWJ342N	Lucky there are some great staff doing an awesome job that make up for the negatives such as the rates and certain people who you don't trust.	
249	35APA22B6C	They should have an open mind and listen to what their rate payers are saying. What they tell you is not going to be what they do. The mayor and Councillors have their own agenda.	
250	36D8F2U42H	More rural input would be wonderful. We get nothing for our rates where we are.	
251	32J3D3NDE7	No.	

252	X8KEV73H64	No.	
253	K3VH48J5G5	A poor management team and they are not working for the district. There are too many liquor outlets in Hokitika. Hopefully with the next election we get some better candidates. We need a change of mayor.	
254	5H7T368E7Q	I think that they need to start looking at footpaths and making sure they are safe.	
255	533KA6HWM7	No.	
256	3678C7S5DJ	It is not the council itself it is the fella at the top. He has 130 failed companies and how he can look after the finances of the council, I don't know. I have a relation in Christchurch with a two-storied immaculate home and he pays less rates than I do. It is not only the rates it is the underhand things that go on.	
257	F5TAMAFTFM	No.	
258	57BVPQ3LG5	No.	
259	CT6N53CTB5	Just keep it up, that's all.	
260	8W243TKGVU	No.	
261	PU7K2T856P	No.	
262	87M8D3Y3XA	Some roads and footpaths need fixing. They are quite uneven.	
263	4L27755LQV	No.	
264	6825K3434Q	The roads are getting worse, they need to up their game. The Kumara junction and Arahura junction is disgraceful. I live rurally and don't even get a collection point for my garbage. I pay the same rates but don't get many facilities.	
265	4JKD4LBAG5	You cannot fault the Westroads staff that is contracted to do all their work. I give them a ten out of ten but they are contracted to what they are allowed to do. I have had a lot of flooding issues on my property with no resolution to it and it is still ongoing.	
266	B8PAL2GC2E	Not really.	
267	4AAETXCE52	I am a computer person but it would be nice to have a place to hang out.	
268	K3753624GS	Happy with the council.	
269	4W2J56W854	They created a big problem up at my farm with the roading which causes a big water problem. Council ignored what we wanted and created a big problem for me.	

270	7SBT545PMM	Better consultation on all projects. We put them there to serve the community.	
271	J42P5854WQ	I think in the next election there will be a change of guard.	
272	78AE8KNQH2	I find the mayor good, he sticks up for people of the district. I am happy with the way they run things.	
273	4M38RHG62Q	I feel they don't listen to the people as much as they should. They went ahead and made Revell Street one way though most of the people in the town didn't want it. The money could have been used for other things like getting another doctor in the town. I know that things have become expensive but they are putting up the rates too frequently and not using the ratepayers money in the right way.	
274	UG7P765663	I believe the mayor advocates for the whole of the district but some of the budgets around town have just blown out so I believe their budgeting is incompetent.	
275	88U48N2668	Not ones that would be useful. It is not just Westland it is NZ and the world. We need leaders that provide leadership. It is going to cost money and it is going to be difficult but somehow we have to get ahead of where we are.	
276	W8AQ5R67Y2	No.	
277	Y73Q3CU7W6	I would have to question why they have 60 staff. I look back 5 years ago and they had only 38 staff. The council sub-contracts their work out so I'm wondering why they have so many staff. For e.g. if you put in an application to build a house, they subcontract it out to people who is based in Christchurch so why isn't the work being done locally here. I think the rate increase is a bit too much considering the stress people have had due to covid. People have lost their jobs and they haven't had a pay rise.	
278	V56F7D2Q3D	No.	
279	BRT5377RB2	No.	
280	2437XK4KYJ	More consultation with ratepayers.	
281	PENY3T2G66	No, I will say that they are prompt if you approach them and I appreciate that.	
282	YC2R644387	I am happy with the council.	

283	FSK7TSGQT5	Put your rates down. Don't charge for water that is not being given. We supply our own water.	
284	P47N5FJRVX	No.	
285	7Q7LA43835	They don't spend a lot of money in Okarito.	
286	387TWJ2M8U	The council doesn't listen to the rate payers and they are wasting our money. They didn't need to spend on making Revell Street one way. They have wasted our money. They made the swimming pool shorter and its not even up to a full length standard so how can anyone train for competitive swimming.	
287	K5JSH84Y3N	No.	
288	X8TPY5L4Q4	Listen to the public and don't go off making trials.	
289	CQB8C3BW84	No.	
290	8UXTAV88UK	They need to get back to improving the infrastructure. I would also like my swimming exercise class back on. Council to consult with the rate payers before spending our money for e.g. Revell Street. The building consents are taking forever and its a very complicated process. Instead of giving us what we had to do all at once there was a lot of back and forth. There should have one form explaining exactly what's required. The footpaths in town especially for the aged are not safe to use.	
291	5MK7TD7M47	No.	
292	7S55GJ58HV	I think they Council is led by the staff and they are the power house, not the Councillors. The people who do the work have the knowledge.	
293	L5NNC43B46	I've never had a problem.	
294	JWBMH76AQ8	No.	
295	3VV67QH5QG	No.	
296	L28C2QV6P4	In the papers or online I saw something about an incineration plant to generate electricity. I thought that idea was quashed, so I am concerned about what is happening there. I am against the water exports and I would like to know what is happening with that too.	
297	KCU5S46U5E	I just get so wound up by this out of control Council. Just in the papers today they are wanting to borrow another \$17.5 million.	
298	QB5E7J77DV	No.	
299	22538TJ3D8	No.	

300	4L5S6G66FV	They are pushing me through the courts. They have a plan to take some locals down through the courts and that is not the role of the Council to do that to it's people. The courts are an eyeopener. The auditors and the local Government minister had auditors to look at the Council. They are not seeing the issues that the rate payers see. The Mayor would clap his hands to see us go down. The West Coast with 4 Councils is way over the top. They need to standardise their Councils and cut back to one District Council and one Regional Council for the West Coast. When you see the administration involved, it is huge and costly.	
301	688P4R4224	No.	
302	763D7YL82Y	I think they have a had good year and it is good. There have been no big controversial things happening and that takes time and effort and they have been doing the basics which is good.	
303	3NQ5V6US48	They need to focus more on core services and less on grand ideas.	
304	4E8KDC67TQ	No.	
305	TK5V44Q57X	I think the rates we are paying are too high. We don't use the facilities we are paying for. I think the way the rating works should be readdressed. The people in the danger zones are paying higher rates. Why don't they introduce something similar for town for how far away from town are you. The further away, the less likely you are to use the services in town.	
306	DDV2HT7C22	No.	
307	B5CULLP7AY	No.	
308	QD3TK637P7	They look after me in my Council flat.	
309	QLS573GN28	No.	
310	6BQ3VTVMNU	They don't listen and people on a pension, they have rates hikes and it's a struggle for them. There are crooks on the Council I believe. When the new lady came to run the Council [REDACTED] I rang them, the lady was so rude. She said she we had to contact our bank and we would have to put that on our mortgage. They don't treat people nicely. Everyone I have spoken to about her dislikes her. It gives you no incentive to want to work with them. There is no respect for people. We have had good people run the town in the past but this group is mad. These people don't seem to have a heart.	

311	37F8SHB673	Cass Square is disappointing with the landscaping. I think they have wasted money in this area. The way they don't maintain the berms. Lots of elderly people can't manage them. They have said the locals need to maintain them. Some look terrible. There is one by Revell street with long grass, I think it could be a fire hazard. I think they could do more the maintain the rough footpaths that are very uneven. This is difficult for the young and old who rely on prams and mobility scooters. More maintenance wouldn't go amiss. Do the basics first with maintenance. One lady in the district has written letters to a public forum that were deemed to be defamatory, so they took her to court. They are now talking about making her bankrupt. That seems to be a very extreme thing to be doing. All she was doing was voicing her opinion. They now seem vindictive with their actions. They are making her bankrupt to cover the court costs so the rate payers don't have to pay. They are trying to make an example of her. It seems a bit like what is happening in the Ukraine at the moment. They could have settled out of Court and through mediation.	
312	G55LA65TF3	I am very satisfied.	
313	FT6N23445V	No.	
314	343E225W2S	I hate reading about the Council in the paper. This spoils the reputation of the town. Nobody seems to have the ability to stand up to The Mayor and tell him to stop. I think in a way, they need to get advice from outside of the area. This needs to be advice not contaminated by any people set to benefit from any local profits.	
315	7D3VG8X728	No.	
316	6323R7V86N	No.	
317	6E2588HW8X	No.	
318	H6NLEH4DGV	When you ring up, they are well mannered and listen to you.	
319	47H7M86N3Y	I don't agree with a lot of stuff they have done. I think the area looks more appealing.	
320	BC26P2B2Y2	No.	
321	T3Y8W7A4B7	No.	

322	R5PYBLW726	The speed regulations in the district, 50K for a portion out of town goes 50K to 80K and back to 50k. This seems a bit strange and should be reviewed and become consistent through the area.	
323	7L8Q227KQN	No.	
324	332RC574B4	Stick to the core work of what Council should do.	
325	W8AGL24Q65	I'd like to see them focusing on the core infrastructure, that seems to be failing.	
326	7WN6EF6QR6	No.	
327	55V334QH5E	I would use the swimming pool but it needs to be pulled down and a new one built. \$7 million for repairs is a lot of money and I don't know where it has gone. I think you could build a new swimming pool for \$7 million. Transparency? We don't know.	
328	BEE36R68LK	No.	
329	22XLP75L26	No.	
330	RXGE7NGN6F	To my way of thinking there is a lot of unnecessary spending on buildings - but there is the earthquake strengthening. There seems to be a massive amount of staff working there compared to what there was years ago - mind you with all the resource consenting they might need more - what do you think?	
331	RR6V368W5C	No.	
332	EKXH8Q48D3	Watch the Government, stand up to the bastards.	
333	8Q2HQQW3NU7	No.	
334	EFH878538N	To listen to the ratepayers a bit more than they do.	
335	546WDMFKVS	No, we get what we vote for and I think the votes have been used quite wisely.	
336	282L73HFGF	When phoning the Council, the front desk want to know your business before putting you through. I don't like that. The person we need to speak to tried to get the front desk to sort our problems, I don't like that either. I had a job request in with the Council for coming up 10 years and it's still not resolved. This is about getting a culvert replaced, they keep fobbing me off. I probably would think twice about building a property in the area because of the difficulties that Council put people through when they want to build.	

337	V658BR7F23	No.	
338	M53YV7APJK	The sooner they amalgamate all the Councils on the West Coast the better.	
339	HG7T57JP7N	No.	
340	6R84Y8YQH7	The rates are far too high and a lot of elderly people here can't afford the rates.	
341	76YESW52T7	I think there is a lack of experienced employees in the Council which is detrimental to the ongoing betterment of the district.	
342	6W7D633T4E	No.	
343	H6568442JC	They need to get back to people that enquire about things. It's been 4 months now and I have had no answer from that person. It's quite disheartening.	
344	264YR7VM6W	No.	
345	7EV5S734X5	I just wonder how a survey like this gauges accurate information. I don't have enough knowledge to provide an accurate answer.	
346	A62R6KJA5T	No.	
347	36XK3J4467	It's tough out there for a lot of people. People deserve a bit more compassion. They need to look at what people can afford. They always go back on their word. It really riles me that they don't deliver on their promises.	
348	WQ5ENR277V	No.	
349	77YE28M733	They need to a bit more informative and reach out to young people to make sure they get involved. They say they want more young people on the Coast but I don't see them doing anything to reach out to us.	
350	2RB5EH467J	No.	
351	P338684522	No.	
352	4X36NBL46B	No.	
353	WPBTLAH42C	My Bach is rural and we get nothing for our rates, no rubbish, or ties and according to what they Council says, we are entitled to it but we can't get it. This is frustrating. We have water tanks but we are paying rates for water as well. We tried to get in touch. They said no to our request and then hung up when we asked to speak to someone higher.	
354	L2J538668W	No.	

355	GN3AG8WR23	My footpaths has been damaged for 22 years. This needs to be get done. My requests get put on the back burner.	
356	J2WDW8LUR2	It's a great place to live.	
357	6KG4BGW5B8	No.	
358	32SVGKB8P7	I think that the consultation process and believing rate payers doesn't seem to exist.	
359	4HE3TK7VYL	No.	
360	TS8NPE3462	No.	
361	5MK2M5TDNU	The staff works really well but we are not very well served by our councillors and Mayor.	
362	325NDUN472	No.	
363	82CWA4CV25	No.	
364	256AG8Y5H6	Fix up upper Sewell Street. It has big holes in it. I have given up ringing and complaining as they do nothing about it.	
365	7CAPDJ8M83	No.	
69	4JAS5KYASF	Stop wasting money.	
110	3757SPASR8	Don't undervalue the museum, library, pool. These are community services they don't have to make money.	
111	MJG8F4JV43	The Mayor only listens to what he wants to hear/upset him and you may as well not be on the Council.	
113	3GTK5ESA84	Don't need as many staff, just need efficient ones!	
114	NQKM2PKP8M	Very overloaded with staff. Waste of ratepayers' money.	
115	ACPMLUKMGU	Rates too high for a small rate base. The West Coast has coal mines and plenty of coal left in the area to make use of to help with a rating system for Councils. If Gov't. allowed coal mining, the same with gold, which could be a gold tax for Councils and also the conservation department should be rated for every business that has been given a lease to operate on their land. There is a great abundance of coal and gold left on the coast to pay off NZ's debt and Councils' debt by a rating system.	
116	JXBBW63T4W	Vax passes at pool, library and cinema. Seeing the Mayors of Hoki and Grey in posters telling me and others to get a vaccine or a boostger was not necessary and seemed very in league with socialism! Mayors should be politically neutral.	

123	VXDM228U4H	Lower rates.	
-----	------------	--------------	--

Report to Council



DATE: 26 May 2022
TO: Mayor and Councillors
FROM: Transportation Manager

Vesting of the Cook Flat and Lake Matheson Road Footpath/cycleway as a new Council Asset

1. Summary

- 1.1. The purpose of this report is to consider formally accepting the vesting of the recently constructed footpath/cycleways along Cook Flat and Lake Matheson Roads into Council ownership/management.
- 1.2. This issue arises from the Department of Conservation (DOC) wishing to officially hand over management of the new footpath along Cook Flat Road and Lake Matheson Road in line with a prior informal unsigned MOU created at the start of the construction project.
- 1.3. Council seeks to meet its obligations under the Local Government Act 2002 and the achievement of the District Vision adopted by the Council in June 2021, which are set out in the Long-Term Plan 2021 - 31. Refer page 2 of the agenda.
- 1.4. This report concludes by recommending that Council accept the vesting of the new Cook Flat and Lake Matheson Road footpath/cycleways and associated infrastructure into Council ownership for the continuing maintenance and ongoing future renewal at the end of useful life.

2. Background

- 2.1. The reason the report has come before the Council is that DOC was successful in obtaining specific government funding for a number of projects to improve tourist opportunities in the Fox Glacier area following the loss of the Glacier Access Road in 2019. The extension of the footpath/cycleway along Cook Flat and Lake Matheson Roads is one of the projects that was proposed by the community and supported by DOC. DOC was successful in receiving funding to proceed. DOC entered into a partnership agreement with WDC for WDC staff to assist DOC oversee the general design and construction phases of this project. As the asset has been created within legal road corridor it was logical for Council to take over ownership and maintenance of this facility once the construction defects liability period had expired.
- 2.2. Construction of this footpath started in September 2020, and it was completed in April 2021 at which time the 52-week Defects Liability period started. Prior to the defects period ending WDC Staff carried out a project inspection to identify any outstanding defects that require correction, and this list was presented to DOC and the principal contractor for remediation. At the time of writing there is only 1 outstanding item yet to be corrected but there is an undertaking from the contractor that this will be actioned within the next month or two at no cost to Council or DOC.

3. Current Situation

3.1. The current situation is this footpath/cycleway has now reached then end of the construction defects liability period and still resides in ownership with DOC. However, as the asset is within the legal road corridor responsibility for it from a Health and Safety perspective lies with the landowner. In this instance that is Westland District Council. Ordinarily when projects/subdivisions are carried out by developers the resource consenting process covers off the vesting of created assets into Council Ownership once the subdivisions have had final sign off from District Assets and Planning. In this instance no specific resource consent was required for this work as it is a permitted activity within the road corridor, as such the vesting requires the approval of Council.

4. Options

4.1. Option 1: Accept the vesting of the new Cook Flat and Lake Matheson Road footpath/cycleways and associated infrastructure into Council ownership for the continuing maintenance and ongoing future renewal at the end of useful life.

4.2. Option 2: Decline the vesting of the new Cook Flat and Lake Matheson Road footpath/cycleways into Council ownership and advise DOC the asset will need to be maintained by their organisation.

5. Risk Analysis

5.1. Risk has been considered and there is a risk that if Council does not accept the vesting, then DOC will/may not be in a position financially to continue to undertake ongoing maintenance or renewal of this and associated assets. This will then cause the path to deteriorate and become unsafe for public use. This is an unacceptable outcome that will require some form of ongoing Council intervention.

6. Health and Safety

6.1. Health and Safety has been considered and no items have been identified.

7. Significance and Engagement

7.1. The level of significance has been assessed as being minor.

7.1.1. No public consultation is considered necessary;

8. Assessment of Options (including Financial Considerations)

8.1. Option 1 – Accept the vesting of the new Cook Flat and Lake Matheson Footpath. The present book value for these assets will add an additional \$309,690 in value to Councils Footpath and Road Drainage Assets Registers. This will also add an additional figure of approximately \$2,706 for annual depreciation (based on a 10-year asset lifespan for the unsealed pavement, 50-year lifespan for the timber edging and an 80-year lifespan for the culverts)

8.1.1. The following financial implications have been identified. There will be an ongoing annual maintenance cost for maintaining the footpath surface, and vegetation control and that has been estimated at approximately \$1,120/yr. The larger proportion of this is anticipated to be vegetation control. (Mowing & Spraying)

8.1.2. The item is unbudgeted expenditure and will be funded from the existing land transport budgets for footpath and or cycleway maintenance which also attracts a subsidy of 62% from Waka Kotahi NZTA.

8.2. Option 2 – Decline the vesting of Cook Flat and Lake Matheson Road Footpath/cycleways into Council ownership.

8.2.1. There are no financial implications to this option.

9. Preferred Option(s) and Reasons

- 9.1. The preferred option is Option 1 – Accept the vesting of the new Cook Flat and Lake Matheson Road footpath/cycleways and associated infrastructure into Council ownership for the continuing maintenance and ongoing future renewal at the end of useful life.
- 9.2. The reason that Option 1 has been identified as the preferred option is that this has always been the intent of the original informal agreement between WDC and DOC. DOC were successful in obtaining the full funding for the construction of this project for the betterment of the Fox Glacier community in general and as such it is consistent with Council's roll to continue to support this community through the continued improvement or creation of infrastructure that serves to improve the community wellbeing.

10. Recommendation(s)

- 10.1. That the report be received.
- 10.2. That Council resolves to adopt Option 1 and accept the vesting of the new Cook Flat and Lake Matheson Road footpath/cycleways and associated infrastructure into Council ownership for the continuing maintenance and ongoing future renewal at the end of useful life.

Karl Jackson
Transportation Manager

Appendix a: Fox Path Concept Drawings.pdf

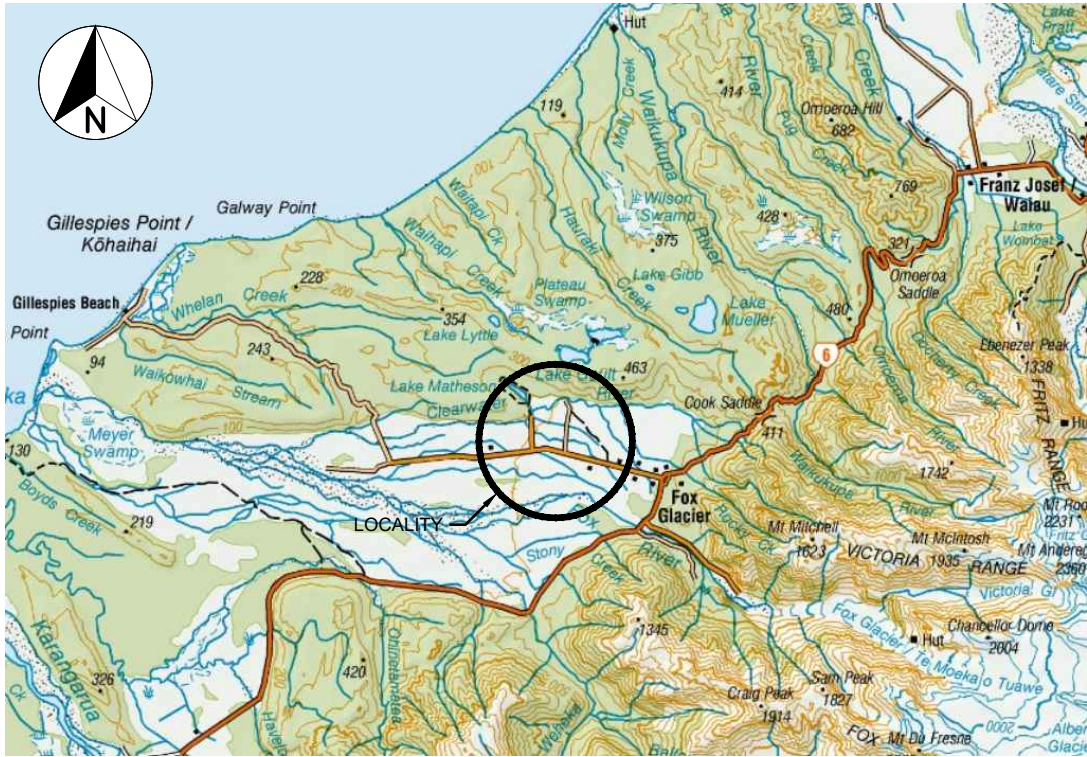

LOCALITY PLAN
NOT TO SCALE

PROJECT NAME:	DAY	16																		
DEPARTMENT OF CONSERVATION	MONTH	12																		
FOX GLACIER SHARED PATH EXTENSION	YEAR	19																		

SHEET No.	DRAWING TITLE	ISSUE																		
C00	LOCALITY PLAN & DRAWING LIST	A																		
C01	OVERALL PLAN	A																		
C02	LAYOUT PLANS - SHEET 1 OF 5	A																		
C03	LAYOUT PLANS - SHEET 2 OF 5	A																		
C04	LAYOUT PLANS - SHEET 3 OF 5	A																		
C05	LAYOUT PLANS - SHEET 4 OF 5	A																		
C06	LAYOUT PLANS - SHEET 5 OF 5	A																		
C07	CIVIL DETAILS - SHEET 1 OF 3	A																		
C08	CIVIL DETAILS - SHEET 2 OF 3	A																		
C09	CIVIL DETAILS - SHEET 3 OF 3	A																		

DISTRIBUTION	NUMBER OF COPIES																			
WSP	1																			
DEPARTMENT OF CONSERVATION	1																			

		REASON FOR ISSUE																	
A = APPROVAL	CP = CONCEPT	REASON FOR ISSUE	CP																
C = CONSTRUCTION	T = TENDER	DRAWING SIZE	A3																
B = AS BUILT	Y = FOR CONSENT	B MEDIA	E																
P = PRELIMINARY	E = ELECTRONIC																		
R = REVIEW	PA = PAPER																		

300 mm
200
100
50
10 mm
0

CONCEPT - FOR DISCUSSION

Revision	Amendment	Approved	Revision Date
A	CONCEPT - FOR DISCUSSION	CAL	16.12.2019



wsp
Greymouth Office
+64 3 769 9330

PO Box 365
Greymouth 7840
New Zealand

Designed	Approved	Approved Date
A RALPH	C LUCAS	16.12.2019
Drawn	Scales	
A RALPH	1:4,000 (A1) 1:8,000 (A3)	

Project		DEPARTMENT OF CONSERVATION COOK FLAT AND LAKE MATHESON ROAD, FOX GLACIER SHARED FOOT AND CYCLE PATH
Sheet		LOCALITY PLAN AND DRAWINGS LIST
Project No.	6-WCON0.74	Sheet No. C00
		Revision A

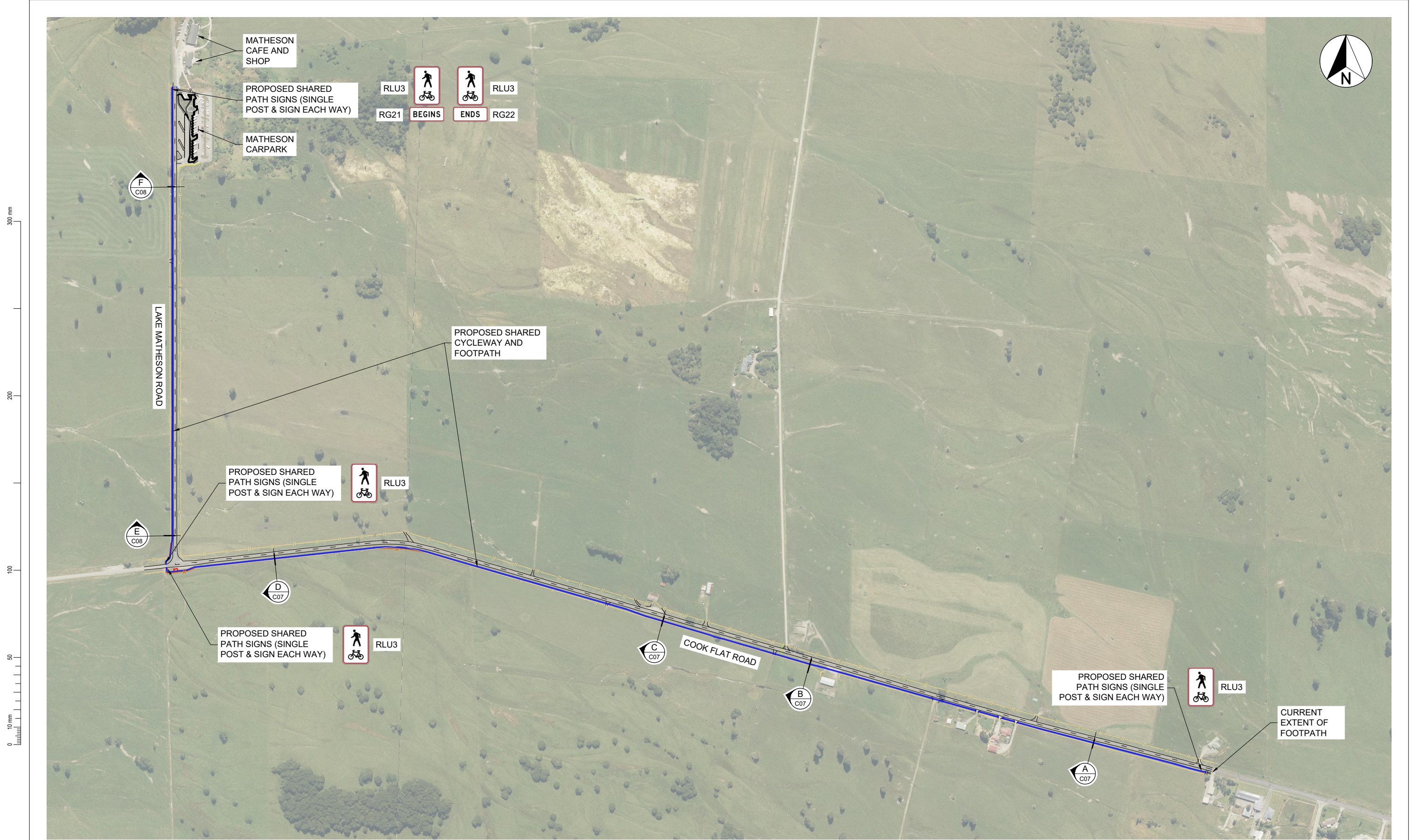

CONCEPT - FOR DISCUSSION

Revision	Amendment	Approved	Revision Date
A	CONCEPT - FOR DISCUSSION	CAL	16.12.2019



wsp
 Greymouth Office
 +64 3 769 9330
 PO Box 365
 Greymouth 7840
 New Zealand

Project		
DEPARTMENT OF CONSERVATION COOK FLAT AND LAKE MATHESON ROAD, FOX GLACIER SHARED FOOT AND CYCLE PATH		
Sheet		
OVERALL PLAN		
Designed	Approved	Approved Date
A RALPH	C LUCAS	16.12.2019
Drawn	Scales	Project No.
A RALPH	1:4,000 (A1) 1:8,000 (A3)	6-WCON0.74
Sheet No.	Revision	
C01	A	

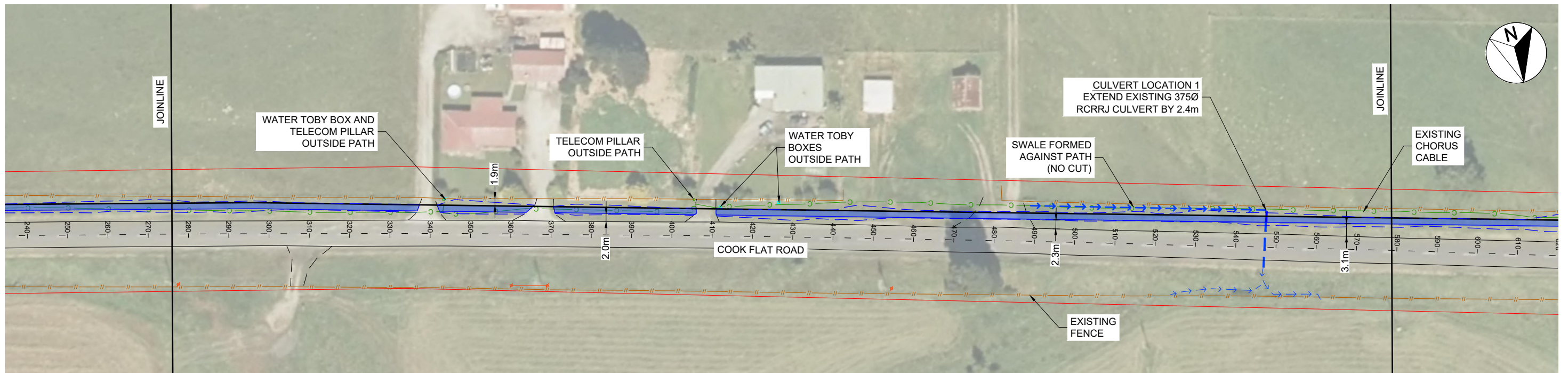
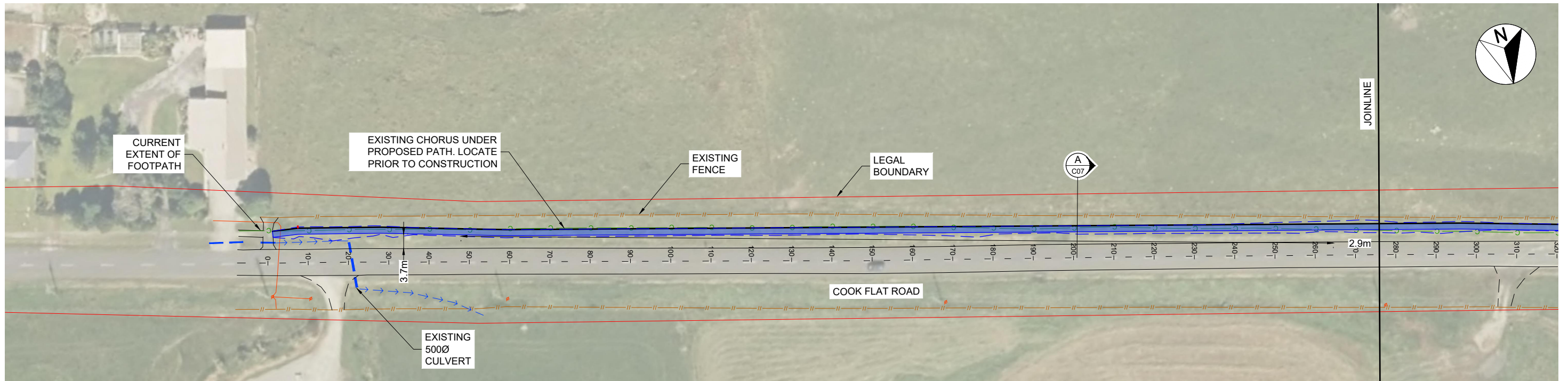

EXISTING SERVICES
DRAWINGS DO NOT NECESSARILY SHOW ALL
EXISTING SERVICES. IT IS THE RESPONSIBILITY OF THE
CONTRACTOR TO LOCATE ALL EXISTING SERVICES
PRIOR TO COMMENCEMENT OF CONSTRUCTION.

NOTES

1. CONFIRM CLASS AND DIAMETER OF EXISTING CULVERTS PRIOR TO PURCHASING NEW LENGTHS.
2. FARMBOSS CULVERTS (OR SIMILAR SMOOTH BORE PE PIPE) TO BE INSTALLED AS PER MANUFACTURERS RECOMMENDATION.

CONCEPT - FOR DISCUSSION



Revision	Amendment	Approved	Revision Date
A	CONCEPT - FOR DISCUSSION	CAL	16.12.2019



wsp
Greymouth Office
+64 3 769 9330
PO Box 365
Greymouth 7840
New Zealand

Project
DEPARTMENT OF CONSERVATION
COOK FLAT AND LAKE MATHESON ROAD, FOX GLACIER
SHARED FOOT AND CYCLE PATH

Sheet
LAYOUT PLANS
SHEET 1 OF 5

Designed	Approved	Approved Date
A RALPH	C LUCAS	16.12.2019
Drawn	Scales	Project No.
A RALPH	1:500 (A1) 1:1,000 (A3)	6-WCON0.74

Sheet No.	Revision
C02	A

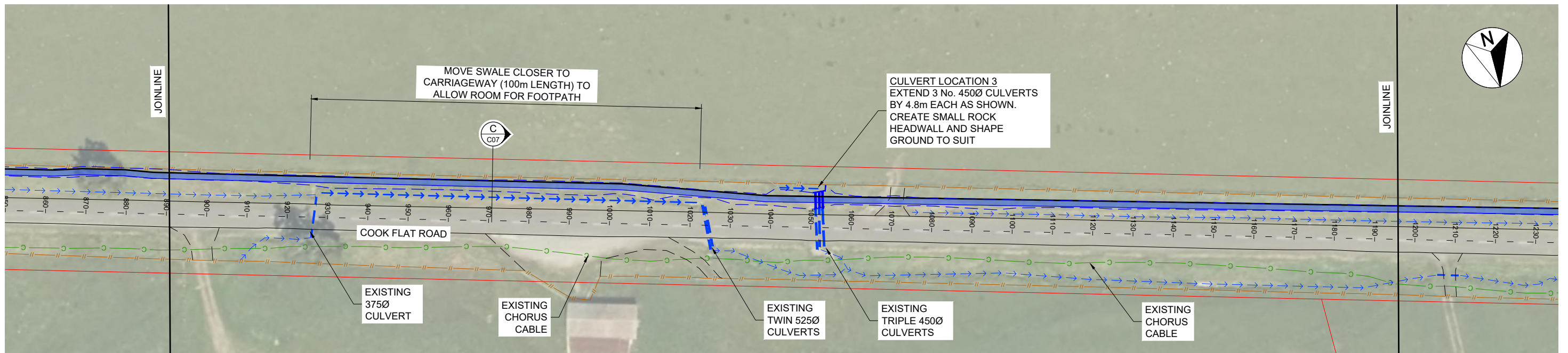
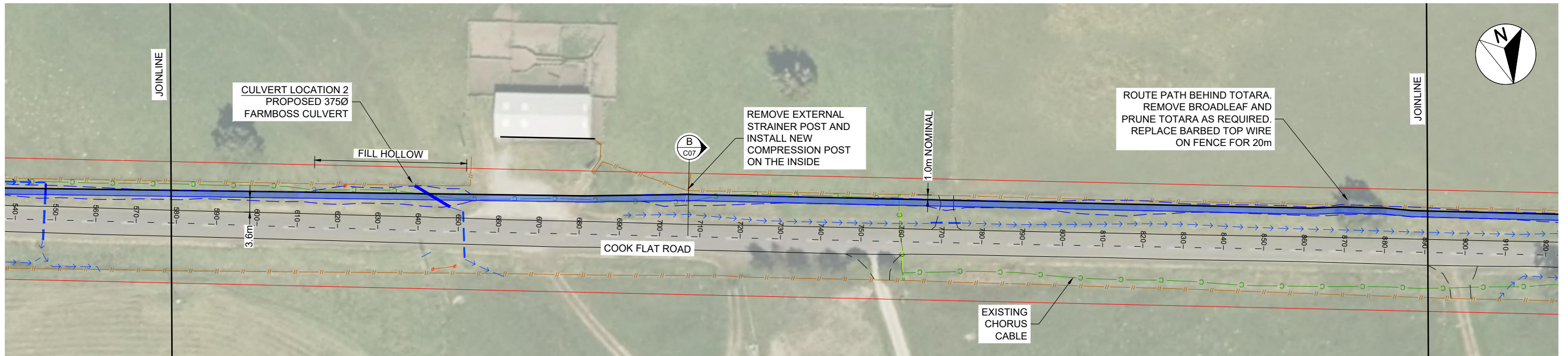

EXISTING SERVICES
DRAWINGS DO NOT NECESSARILY SHOW ALL EXISTING SERVICES. IT IS THE RESPONSIBILITY OF THE CONTRACTOR TO LOCATE ALL EXISTING SERVICES PRIOR TO COMMENCEMENT OF CONSTRUCTION.

NOTES

1. CONFIRM CLASS AND DIAMETER OF EXISTING CULVERTS PRIOR TO PURCHASING NEW LENGTHS.
2. FARMBOSS CULVERTS (OR SIMILAR SMOOTH BORE PE PIPE) TO BE INSTALLED AS PER MANUFACTURERS RECOMMENDATION.

PRELIMINARY - NOT FOR CONSTRUCTION



Revision	Amendment	Approved	Revision Date
A	CONCEPT - FOR DISCUSSION	CAL	16.12.2019



wsp		Project	
Greymouth Office +64 3 769 9330		DEPARTMENT OF CONSERVATION COOK FLAT AND LAKE MATHESON ROAD, FOX GLACIER SHARED FOOT AND CYCLE PATH	
PO Box 365 Greymouth 7840 New Zealand		Sheet	
Designed A RALPH	Approved C LUCAS	Approved Date 16.12.2019	LAYOUT PLANS SHEET 2 OF 5
Drawn A RALPH	Scales 1:500 (A1) 1:1,000 (A3)	Project No. 6-WCON0.74	Sheet No. C03
			Revision A

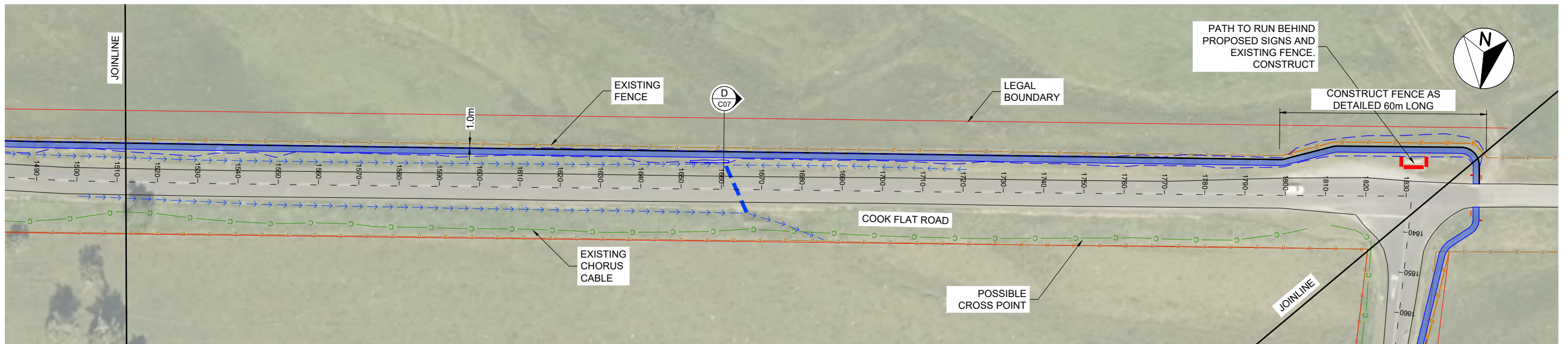
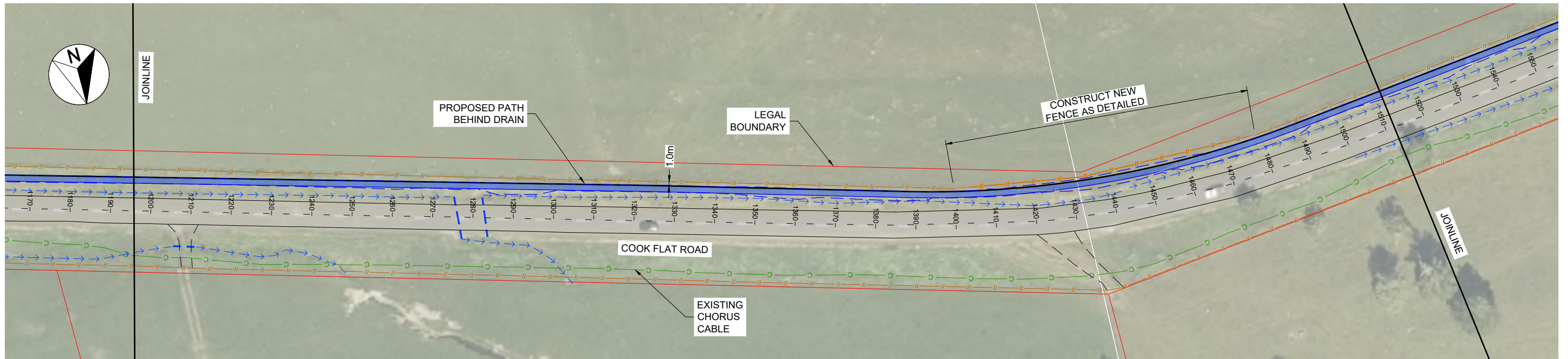

EXISTING SERVICES
DRAWINGS DO NOT NECESSARILY SHOW ALL EXISTING SERVICES. IT IS THE RESPONSIBILITY OF THE CONTRACTOR TO LOCATE ALL EXISTING SERVICES PRIOR TO COMMENCEMENT OF CONSTRUCTION.

- NOTES**
1. CONFIRM CLASS AND DIAMETER OF EXISTING CULVERTS PRIOR TO PURCHASING NEW LENGTHS.
 2. FARMBOSS CULVERTS (OR SIMILAR SMOOTH BORE PE PIPE) TO BE INSTALLED AS PER MANUFACTURERS RECOMMENDATION.

PRELIMINARY - NOT FOR CONSTRUCTION



Revision	Amendment	Approved	Revision Date
A	CONCEPT - FOR DISCUSSION	CAL	16.12.2019



wsp
Greymouth Office
+64 3 769 9330

PO Box 365
Greymouth 7840
New Zealand

Designed: A RALPH
Approved: C LUCAS
Approved Date: 16.12.2019

Drawn: A RALPH
Scales: 1:500 (A1) 1:1,000 (A3)

Project		Sheet No.	Revision
DEPARTMENT OF CONSERVATION COOK FLAT AND LAKE MATHESON ROAD, FOX GLACIER SHARED FOOT AND CYCLE PATH			
LAYOUT PLANS SHEET 3 OF 5			
Project No.	6-WCON0.74	Sheet No.	C04
		Revision	A

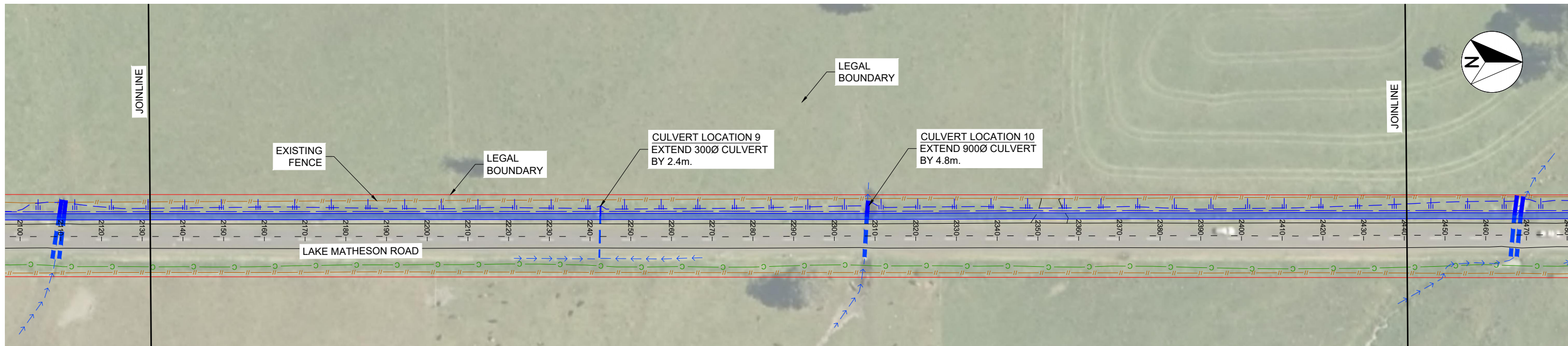
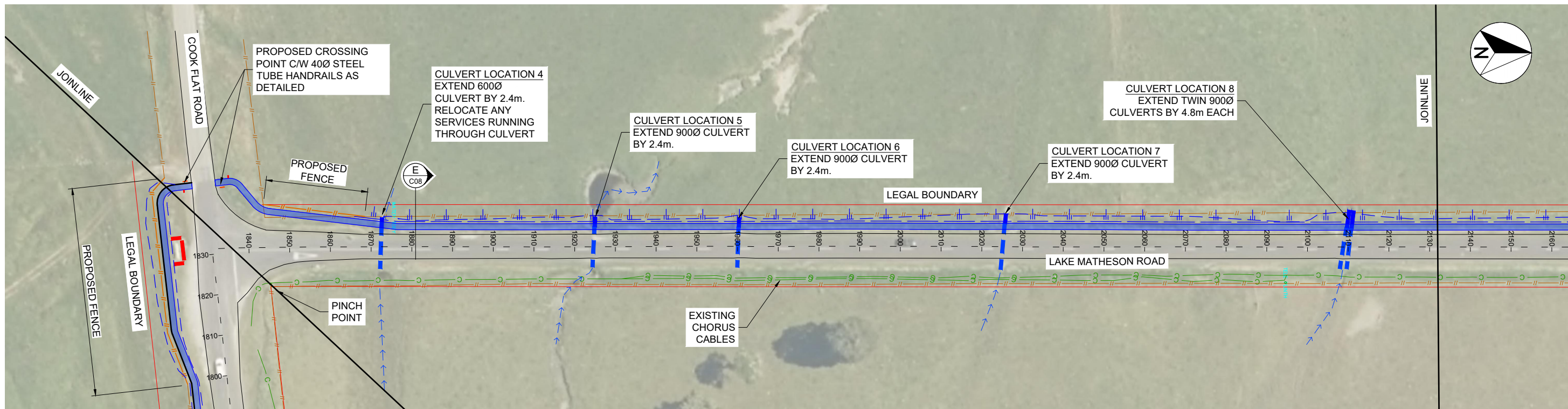

EXISTING SERVICES
DRAWINGS DO NOT NECESSARILY SHOW ALL EXISTING SERVICES. IT IS THE RESPONSIBILITY OF THE CONTRACTOR TO LOCATE ALL EXISTING SERVICES PRIOR TO COMMENCEMENT OF CONSTRUCTION.

- NOTES**
1. CONFIRM CLASS AND DIAMETER OF EXISTING CULVERTS PRIOR TO PURCHASING NEW LENGTHS.
 2. FARMBOSS CULVERTS (OR SIMILAR SMOOTH BORE PE PIPE) TO BE INSTALLED AS PER MANUFACTURERS RECOMMENDATION.

PRELIMINARY - NOT FOR CONSTRUCTION



Revision	Amendment	Approved	Revision Date
A	CONCEPT - FOR DISCUSSION	CAL	16.12.2019



wsp
Greymouth Office
+64 3 769 9330

PO Box 365
Greymouth 7840
New Zealand

Designed
A RALPH

Approved
C LUCAS

Approved Date
16.12.2019

Drawn
A RALPH

Scales
1:500 (A1) 1:1,000 (A3)

Project	
DEPARTMENT OF CONSERVATION COOK FLAT AND LAKE MATHESON ROAD, FOX GLACIER SHARED FOOT AND CYCLE PATH	
Sheet	
LAYOUT PLANS SHEET 4 OF 5	
Project No.	Sheet No.
6-WCON0.74	C05
Revision	A

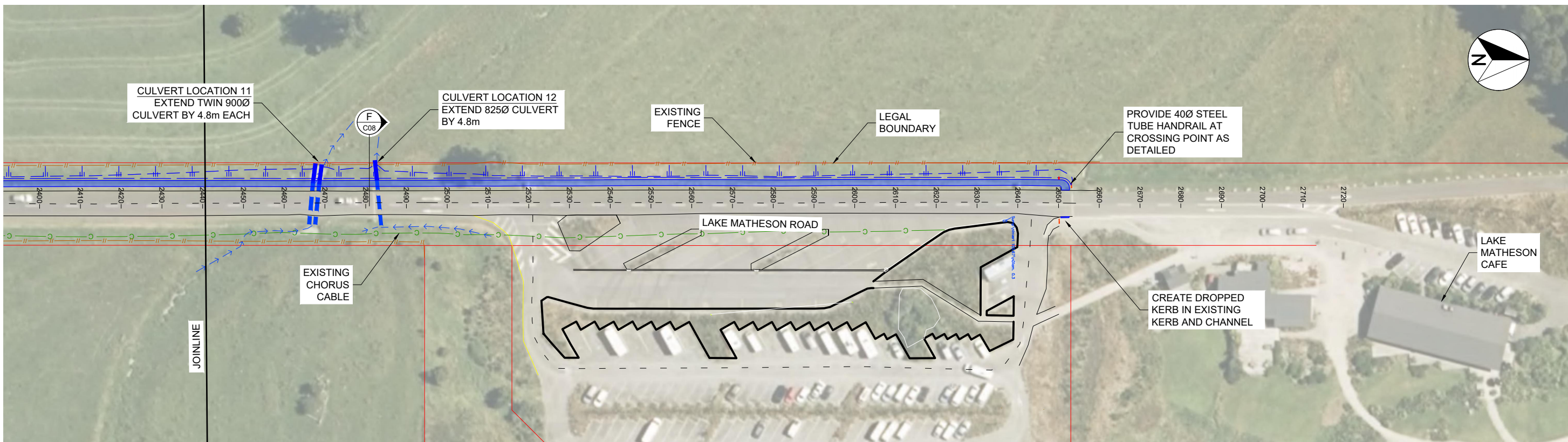

300 mm
200
100
50
10 mm
0

EXISTING SERVICES
DRAWINGS DO NOT NECESSARILY SHOW ALL EXISTING SERVICES. IT IS THE RESPONSIBILITY OF THE CONTRACTOR TO LOCATE ALL EXISTING SERVICES PRIOR TO COMMENCEMENT OF CONSTRUCTION.

- NOTES**
1. CONFIRM CLASS AND DIAMETER OF EXISTING CULVERTS PRIOR TO PURCHASING NEW LENGTHS.
 2. FARMBOSS CULVERTS (OR SIMILAR SMOOTH BORE PE PIPE) TO BE INSTALLED AS PER MANUFACTURERS RECOMMENDATION.



1:500 @ A1
1:1000 @ A3
0 5 10 15 20 25 30 35 40 45 50 m
26 May 2022 Westland District Council Meeting Agenda

Revision	Amendment	Approved	Revision Date
A	CONCEPT - FOR DISCUSSION	CAL	16.12.2019



wsp
Greymouth Office
+64 3 769 9330

PO Box 365
Greymouth 7840
New Zealand

Designed	Approved	Approved Date
A RALPH	C LUCAS	16.12.2019
Drawn	Scales	
A RALPH	1:500 (A1) 1:1,000 (A3)	

Project
DEPARTMENT OF CONSERVATION
COOK FLAT AND LAKE MATHESON ROAD, FOX GLACIER
SHARED FOOT AND CYCLE PATH

Sheet
LAYOUT PLANS
SHEET 5 OF 5

Project No.	Sheet No.	Revision
6-WCON0.74	C06	A

PRELIMINARY - NOT FOR CONSTRUCTION

300 mm
200
100
50
10 mm
0

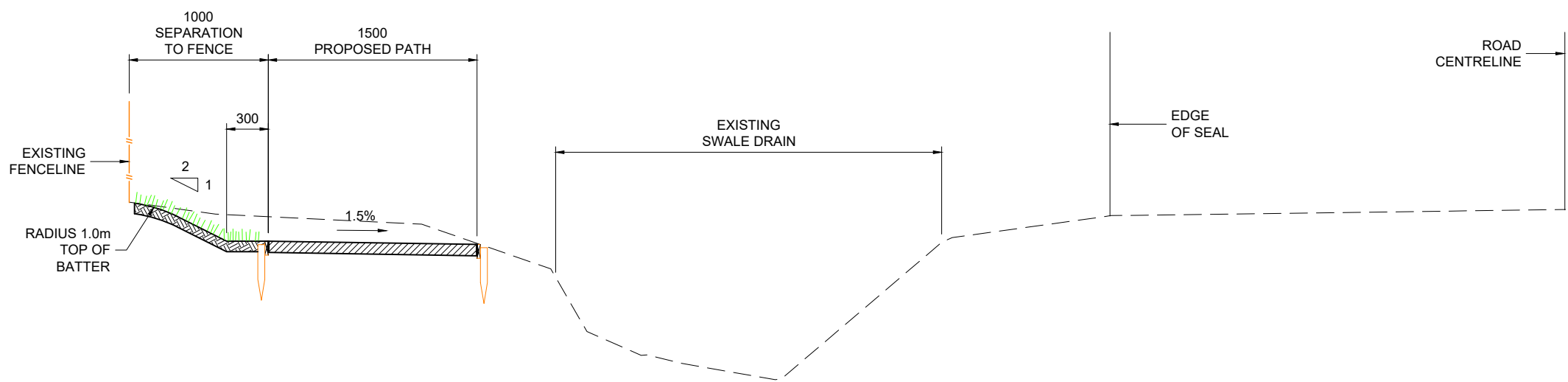

TYPICAL SECTION D
COOK FLAT ROAD - CH1668.0
SCALE 1:20 (A1) 1:40 (A3)

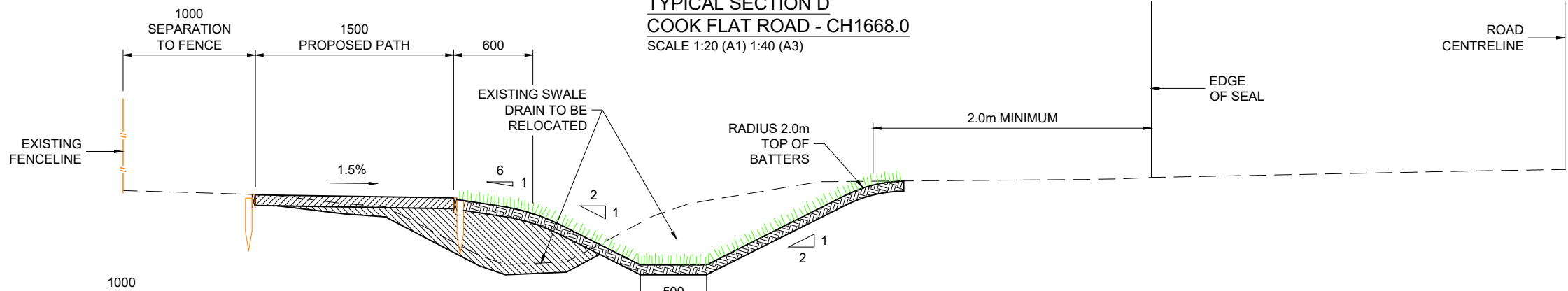

TYPICAL SECTION C
COOK FLAT ROAD - CH970.0
SCALE 1:20 (A1) 1:40 (A3)

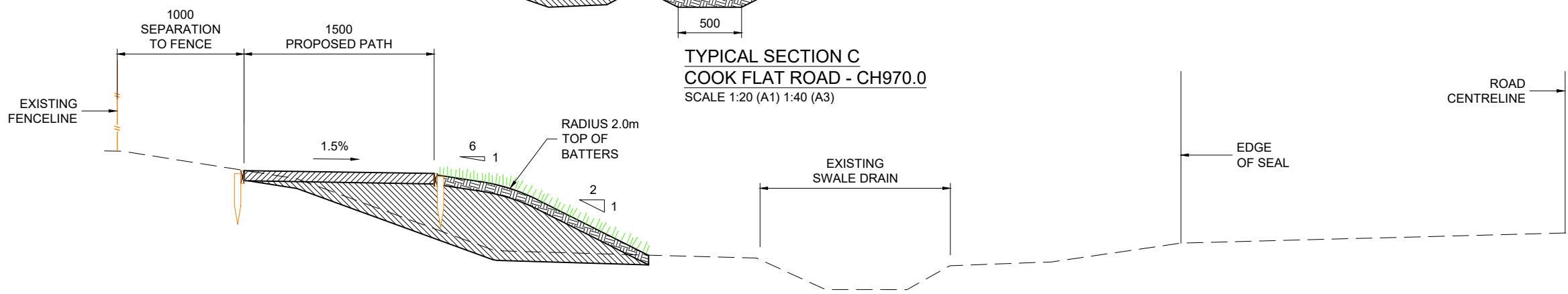

TYPICAL SECTION B
COOK FLAT ROAD - CH710.0
SCALE 1:20 (A1) 1:40 (A3)

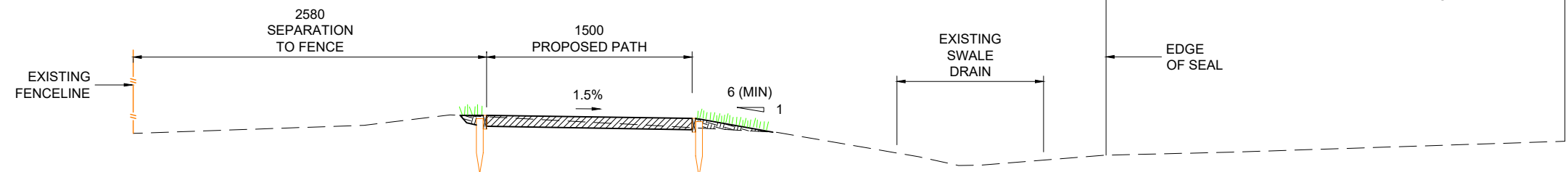

TYPICAL SECTION A
COOK FLAT ROAD - CH200.0
SCALE 1:20 (A1) 1:40 (A3)

CONCEPT - FOR DISCUSSION

NOTES
1. REFER SHEET C08 FOR PATH DETAILS

Revision	Amendment	Approved	Revision Date
A	CONCEPT - FOR DISCUSSION	CAL	16.12.2019



wsp
Greymouth Office
+64 3 769 9330

PO Box 365
Greymouth 7840
New Zealand

Designed	Approved	Approved Date
A RALPH	C LUCAS	16.12.2019
Drawn	Scales	
A RALPH	AS SHOWN	

Project	
DEPARTMENT OF CONSERVATION COOK FLAT ROAD AND LAKE MATHESON ROAD, FOX GLACIER PROPOSED SHARED CYCLEWAY/FOOTPATH	
Sheet	
CIVIL DETAILS - SHEET 1 OF 3	
Project No.	Sheet No.
6-WCON0.74	C07
Revision	
A	

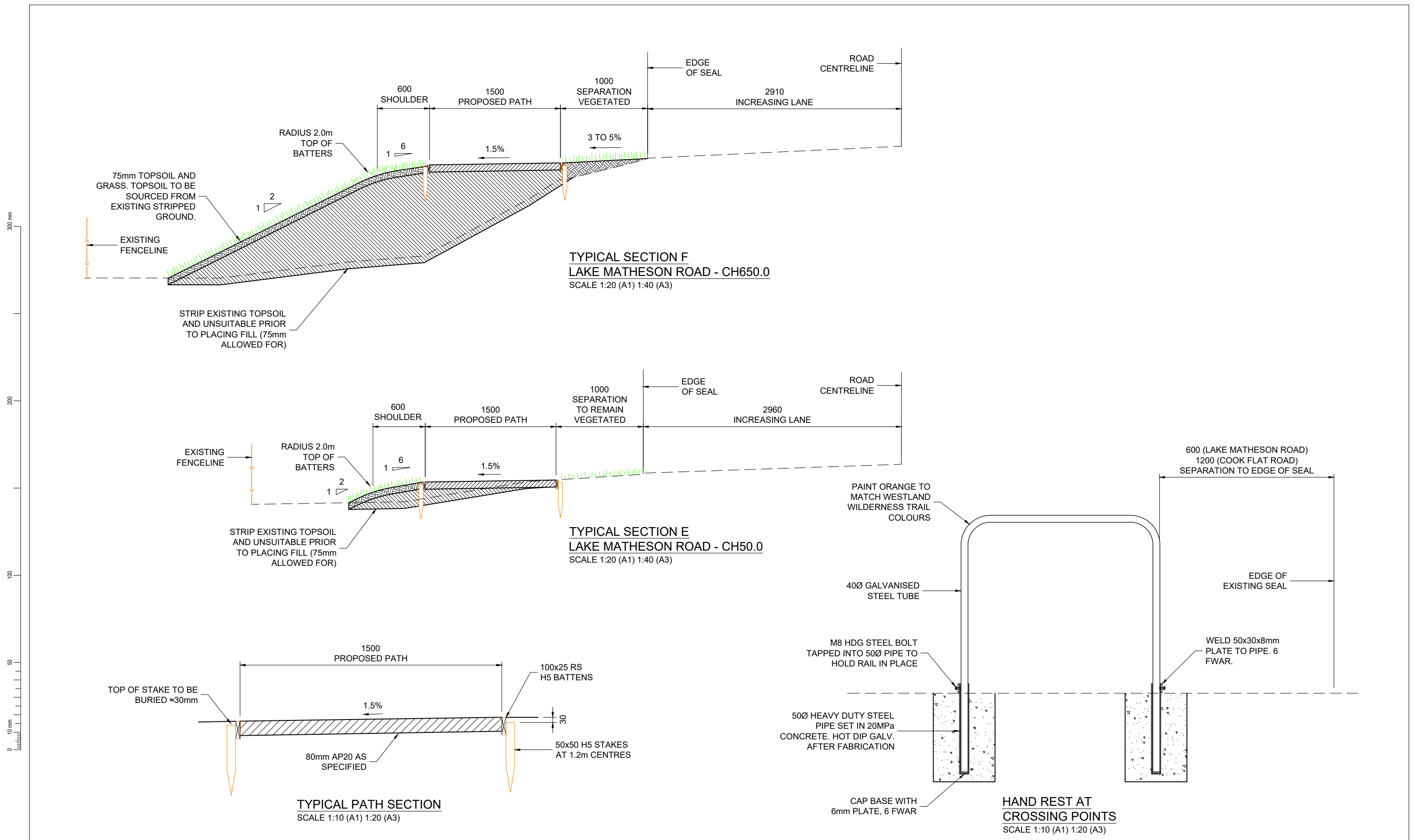

CONCEPT - FOR DISCUSSION

Revision	Amendment	Approved	Revision Date
A	CONCEPT - FOR DISCUSSION	CAL	16.12.2019



wsp
Greymouth Office
+64 3 769 9330

PO Box 365
Greymouth 7840
New Zealand

Designed: A RALPH
Approved: C LUCAS
Approved Date: 16.12.2019

Drawn: A RALPH
Scales: AS SHOWN

Project		
DEPARTMENT OF CONSERVATION COOK FLAT ROAD AND LAKE MATHESON ROAD, FOX GLACIER PROPOSED SHARED CYCLEWAY/FOOTPATH		
Sheet		
CIVIL DETAILS - SHEET 2 OF 3		
Project No.	Sheet No.	Revision
6-WCON0.74	C08	A

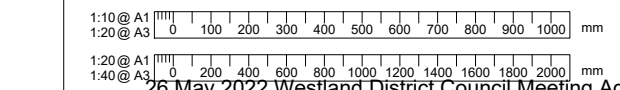

300 mm
200
100
50
10 mm
0

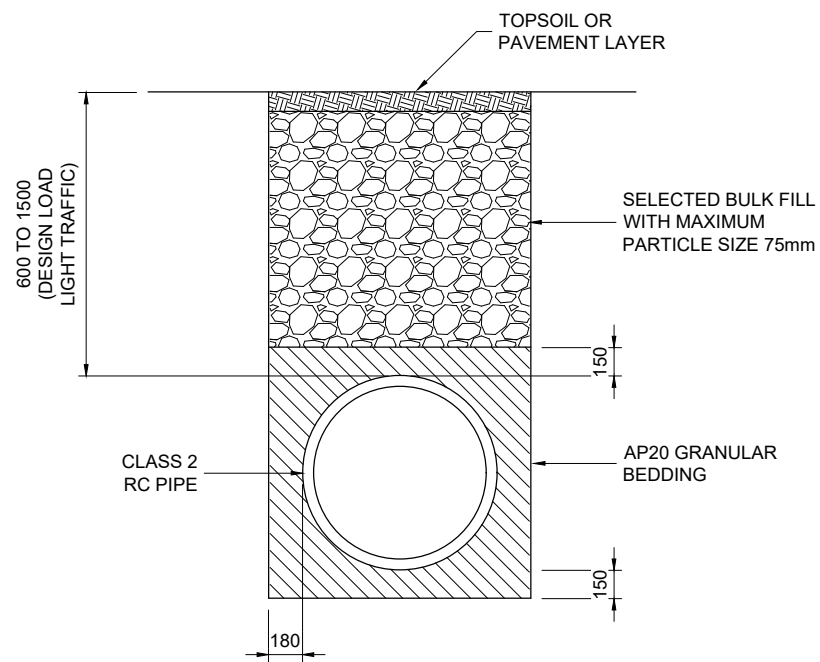

**TYPICAL CONCRETE CULVERT
EXTENSION BEDDING**
SCALE 1:20 (A1) 1:40 (A3)

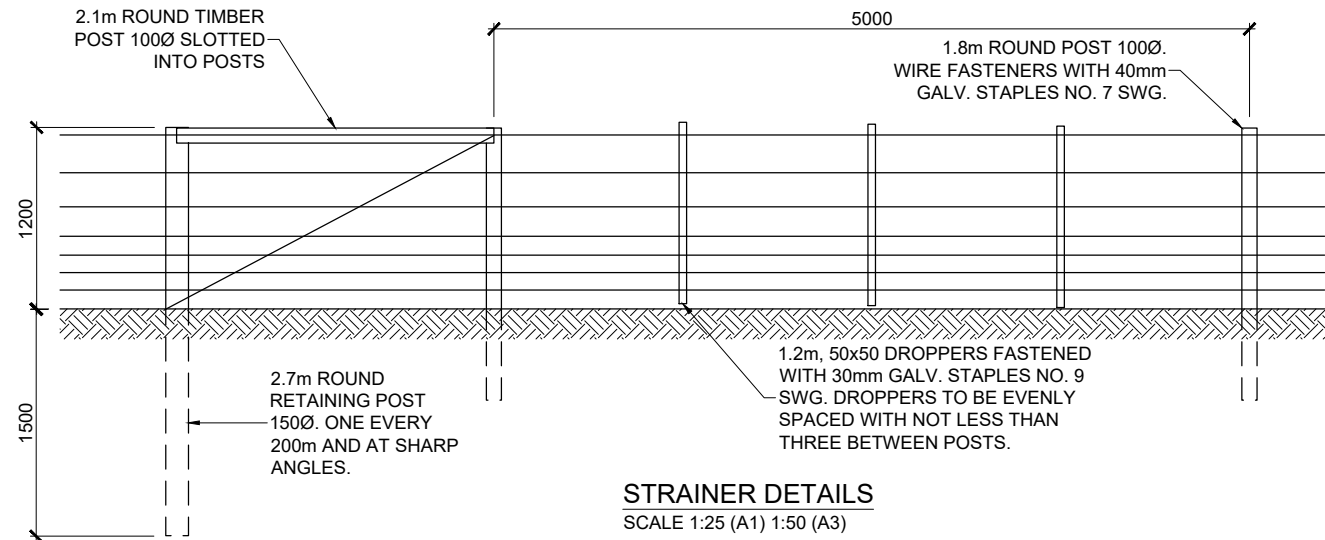

STRAINER DETAILS
SCALE 1:25 (A1) 1:50 (A3)

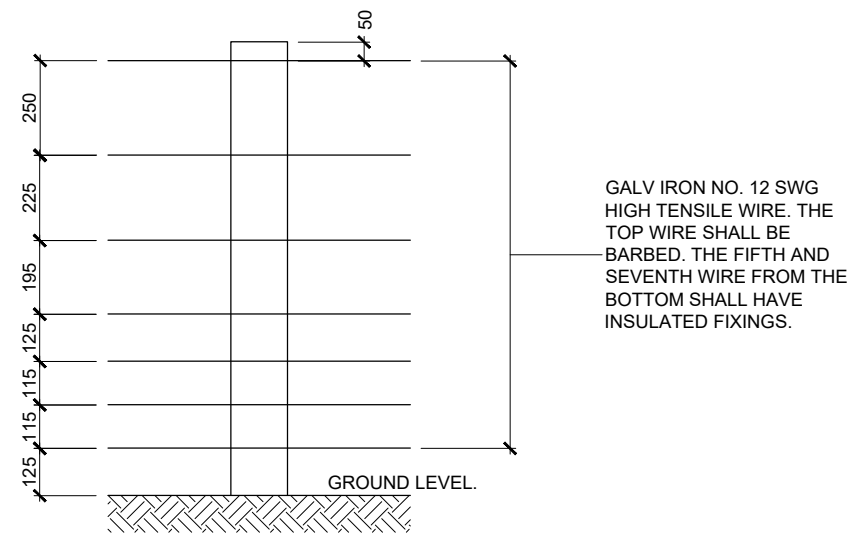

**STANDARD POST AND
WIRE FENCE DETAILS**
SCALE 1:10 (A1) 1:20 (A3)

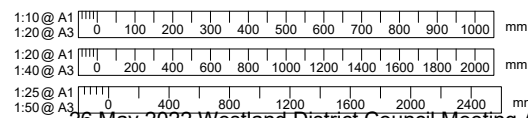

Revision	Amendment	Approved	Revision Date
A	CONCEPT - FOR DISCUSSION	CAL	16.12.2019



Greymouth Office +64 3 769 9330		
PO Box 365 Greymouth 7840 New Zealand		
Designed	Approved	Approved Date
A RALPH	C LUCAS	16.12.2019
Drawn	Scales	
A RALPH	AS SHOWN	

Project DEPARTMENT OF CONSERVATION COOK FLAT ROAD AND LAKE MATHESON ROAD, FOX GLACIER PROPOSED SHARED CYCLEWAY/FOOTPATH		
Sheet CIVIL DETAILS - SHEET 3 OF 3		
Project No.	Sheet No.	Revision
6-WCON0.74	C09	A

Report to Council



DATE: 26 May 2022

TO: Mayor and Councillors

FROM: Te Aroha Cook - GM Regulatory and Community Services

Hokitika Museum Trust Board

1. Summary

- 1.1. The purpose of this report is to seek Council approval to establish a Hokitika Museum Trust Board with the primary function to identify and make successful applications from funding bodies to offset the cost of the proposed project(s). This will support the Museum in providing quality services and activities for Westland District communities and visitors.
- 1.2. This issue arises from the Hokitika Museum requiring funding and support to carry out significant projects such as the Ngā Whakatūranga Project (Carnegie gallery development project), the Te Whata Nui Project (Archives and Programming), and the collection readiness project(s).
- 1.3. Council seeks to meet its obligations under the Local Government Act 2002 and the achievement of the District Vision adopted by the Council in June 2021, which are set out in the Long Term Plan 2021 - 31. Refer page 2 of the agenda.
- 1.4. This report concludes by recommending that Council endorses the establishment of the Hokitika Museum Trust Board, and seeking of expressions of interest/application from suitable candidates.

2. Background

- 2.1. The reason the report has come before the Council is due to the need to raise significant external funding for Hokitika Museum projects.
- 2.2. The Hokitika Museum's projects, like the Ngā Whakatūranga Project, enhance understanding of the natural and cultural heritage of the West Coast region, especially the Westland District. This promotes a greater cultural and social wellbeing within the Westland District community.
- 2.3. In the absence of a constituted Museum Board or Trust, funding avenues available to the Museum are limited, as Local Authorities are often excluded in funding criteria despite having management responsibilities for facilities such as the Museum. Establishment of a Museum Board / Trust would enable applications to be made to external funding bodies, and where successful, would offset the cost of proposed, and future projects on the Westland District rate payer.

3. Current Situation

- 3.1. The current situation is that with limited financial resources, cost inflation for materials and services required to develop outputs for projects, the Hokitika Museum requires external funders to partner with such projects. There is a need to have a dedicated Hokitika Museum Trust that is responsible, equipped with funding expertise, and able to identify and apply successfully to external funds to ensure that these crucial projects are delivered to a professional level.
- 3.2. A Terms of Reference for the Museum Trust Board that establishes its relationship with Council and delegations will be developed following Council's determination on how it wishes to proceed. A draft Constitution will also be prepared.
- 3.3. It is proposed that a Museum Trust Board is established consisting of five members. Applications or Expressions of Interest from suitable candidates would be sought externally following adoption of Council's 2022/2023 Annual Plan.
- 3.4. Appointment of suitable candidates would be via a Selection and Appointments Committee comprising of the Mayor, Council's Heritage Hokitika Committee representative, the Chief Executive, and the Group Manager Regulatory and Community Services.

4. Options

- 4.1. Option 1: Establish the proposed Hokitika Museum Trust Board consisting of five members. The Hokitika Museum Trust Board will be required to identify and apply successfully to external funds to ensure that these crucial projects are delivered to a professional level.
- 4.2. Option 2: Not establish a Hokitika Museum Trust Board. The Westland District Council would be required to identify funding avenues for Hokitika Museum projects and services to enable achievement of desire objectives.

5. Risk Analysis

- 5.1. Risk has been considered. Should Council not endorse establishing a Museum Trust Board, while this does not prevent projects from proceeding, it may impact on the ability to deliver within expected timeframes due to funding constraints. As previously highlighted, a constituted Trust is able to make application to funding bodies / organisations that are not accessible by a local authority. There is a risk that in not establishing a Trust Board, Council may be required to increase the demand on rates to enable projects to be completed within specified timeframes.

6. Health and Safety

- 6.1. Health and Safety has been considered and no items have been identified.

7. Significance and Engagement

- 7.1. The level of significance has been assessed as being low.
- 7.2. No public consultation is considered necessary.

8. Assessment of Options (including Financial Considerations)

- 8.1. Option 1 – Establishing the Hokitika Museum Trust would enable the Hokitika Museum to deliver their prioritised projects and services with minimal delay, convenience to the Westland District

communities, and offset financial pressure on the rate payer. The only financial consideration would be to supply an honorarium fee to each Trustee for each Hokitika Museum Trust Meeting. This financial arrangement would compensate trustees for their services and expected output for the Museum's projects over the next three years. This financial requirement has been provided for within the Draft Annual Plan 2022/2023.

8.2. Option 2 - The Westland District Council absorbing all financial responsibility with no external funding for the Hokitika Museum's prioritised projects and services would place increased financial pressure on the Westland District ratepayer. In addition, the expected deliverables and service outputs would have significant delays and general inconvenience to Westland District communities.

8.3. The following financial implications have been identified for each option.

8.4. The financial item for Option 1 has been provided for in the Draft 2022/2023 Annual Plan. Option 2 would result in consideration for provision of unbudgeted expenditure in addition to that already provided for in the Long-Term Plan, and if not funded by external grants, may need to be funded through rates.

9. Preferred Option(s) and Reasons

9.1. The preferred option is Option 1 as it provides the mechanisms to offset the Hokitika Museum's project and services cost on Rates

9.2. The reason that Option 1 has been identified as the preferred option is that it allows for the Hokitika Museum Trust to develop robust approaches and have the ability to respond to all funding opportunities.

10. Recommendation(s)

10.1 That the report be received.

10.2 That Council endorse the establishment of the Hokitika Museum Trust Board and seeking of expressions of interest / applications of suitable candidates

10.3 That the Selection and Appointments Committee comprise, the Mayor, Council's Heritage Hokitika Committee representative, the Chief Executive, and the Group Manager Regulatory and Community Services.

Te Aroha Cook
Group Manager Regulatory and Community Services